



Publisher:

Solare Datensysteme GmbH
Fuhrmannstr. 9
72351 Geislingen-Binsdorf
Germany

Tel.: +49 7428 9418 200

Fax: +49 7428 9418 280

E-mail: info@solar-log.com

Technical support:

End customers and non-certified installers

Tel.: +49 900 1737564*

Installation questions from certified installers and Solar-Log™ partners

Tel.: +49 7428 9418 660

Service and planning inquiries

Tel.: +49 7428 9418 660

International support for countries without country partners

Tel.: +49 7428 9418 640

E-mail: info@solar-log.com

Switzerland

Technical support: +41 565 355346

E-mail: switzerland-fl-support@solar-log.com

*0.59 Euro per one-minute increment for calls from German landline phones. Prices for calls from mobile phones may vary.

Table of Contents

1	Introduction	8
2	Safety information	9
2.1	Hazard Classes	9
3	Electric current	10
4	Package Contents and Installation	11
5	Solar-Log Base Connections	12
5.1	Top Connections Solar-Log Base.....	12
5.2	Solar-Log Base LEDs	13
5.3	Bottom Connections Solar-Log Base.....	14
6	Connector Assignments and Wiring	15
6.1	Notes on wiring the connections	15
6.2	General PIN Assignment	16
7	Connecting the inverters	17
7.1	Switch off the inverters and the Solar-Log Base.....	18
8	Connecting accessories	19
8.1	Sensor Box Basic and Professional	19
8.2	Sensor Box Professional Plus.....	21
8.3	Large External Displays	24
8.4	External Power Meter	25
8.4.1	External power meters/accumulating meters.....	26
8.5	Wiring for RS485 meter	26
8.6	Installation Utility Meter / Janitza UMG 104 / UMG 604 (only Solar-Log Base 2000).....	28
8.6.1	Connecting the Utility Meter to the power grid	29
8.7	Solar-Log™ Smart Relay Box	32

8.8	WeMo Insight Switch.....	34
8.9	Allnet Network Power Socket.....	35
8.9.1	Connecting the Allnet network power socket to the Solar-Log Base	36
9	Other connections	37
9.1	USB	37
10	Installation	38
10.1	Connect the Solar-Log Base to a network / PC	38
10.2	Initial set up of the Solar-Log Base	39
11	Go to the Main Menu.....	40
11.1	Operating the Main Menu of the Solar-Log Base.....	43
11.1.1	Control elements.....	44
11.2	Explanations of the names in the main menu.	45
11.2.1	Header bar	45
11.2.2	Left-side navigation menu	45
11.2.3	Configuration Page.....	45
11.2.4	Login Section Menu.....	46
11.2.5	Hide arrow.....	48
11.2.6	New Firmware	48
11.2.7	Installation Mode	50
11.3	Setting up of the Solar-Log™ with the configuration assistant	52
11.3.1	Manual Configuration of the Solar-Log Base	60
12	Main menu	61
12.1	Virtual LCD Display (VLC Display)	61
12.2	Meaning of the symbols on the virtual LCD display (VLCD Display)	62
12.3	Fault messages	63
12.4	Normal operation.....	63
12.5	Configuration.....	64
12.5.1	Network.....	64
12.5.1.1	Ethernet.....	65
12.5.1.2	Interface ETH 1	65
12.5.1.3	Interface ETH 2	67
12.5.2	Proxy	68
12.6	Internet.....	69
12.6.1	Portal.....	69
12.6.2	Export.....	71
12.7	Configuring connected devices	71
12.7.1	Device definition.....	71
12.7.2	Device Detection	74
12.7.3	Configuring devices.....	75

12.7.4	Generation Information on PAC Correction Factor.....	76
12.7.5	Configuring power meters	77
12.7.6	Configuring sensors	78
12.7.7	Configure the battery.....	78
12.7.8	Configuring EGO Smart Heaters	79
12.7.9	Configuring IDM Heat Pumps	80
12.7.10	Configuring the Keba Power Charging Stations	81
12.7.11	Module Fields, Power Output and Descriptions	82
12.8	Configuring Plant Data.....	84
12.8.1	General	84
12.8.2	Plant groups	84
12.8.3	Graphic.....	85
12.8.4	Defining the PV plant's forecast data	85
12.9	Smart Energy.....	87
12.9.1	Defining Smart Energy Switching	87
12.9.2	Configuring the Switches.....	88
12.9.3	Smart Energy Switching Groups	89
12.9.4	Configuring switching groups	93
12.9.5	Control Logics Definition - Operating Mode Appliances	93
12.9.6	Control Logics Definition - Operating Mode Generator	99
12.9.7	Smart Energy Surplus Management	101
12.10	Feed-In Management	103
12.10.1	Plant parameters	103
12.11	Active power	105
12.11.1	Active power deactivated.....	106
12.11.2	Remote controlled Active Power Restriction (only with additional Mod I/O module).....	106
12.11.3	Remote controlled reactive power restriction with the calculation of self-consumption (only with additional Mod I/O module)	109
12.11.4	70% fixed reduction	109
12.11.5	70% Fixed reduction with the calculation of self-consumption.....	110
12.11.6	Adjustable reduction	111
12.11.7	Adjustable Reduction with the Calculation of Self-Consumption.....	111
12.11.8	Fixed reduction in watts.....	112
12.11.9	Fixed reduction in watts with the calculation of self-consumption	112
12.11.10	Percentage of consumption for an adjustable reduction	112
12.12	Reactive Power	113
12.12.1	Reactive power deactivated	114
12.12.2	Fixed value cos (Phi) shift factor	114
12.12.3	Fixed reactive power in Var	114
12.12.4	Variable cos (Phi) shift factor over characteristic curve P/Pn	115
12.12.5	Variable shift factor cos(Phi) (U).....	116
12.12.6	Variable reactive power via the characteristic curve Q(U)	117
12.12.7	Remote controlled variable shift factor cos(Phi) (only with additional Mod I/O module).....	119
12.12.8	Linking - Master/Slave (Solar-Log Base 2000).....	122
12.12.9	Profile	123
12.13	ModbusTCP PM.....	124
12.14	Direct Marketing.....	124
12.15	Data.....	125
12.15.1	Initial yield.....	126
12.15.2	Data correction.....	127
12.15.3	System backup	127

12.15.4 Backup.....	129
12.15.5 Reset.....	131
12.16 System Configuration.....	132
12.16.1 Access control.....	132
12.16.2 HTTPS.....	133
12.16.3 Language/Country/Time.....	134
12.16.4 Licenses.....	135
12.16.5 Firmware.....	137

13 Diagnostics Menu.....139

13.1 Inverter Diagnostic.....	139
13.1.1 Inverter details.....	140
13.1.2 Tracker comparison.....	141
13.1.3 Module field comparison.....	142
13.2 Battery Diagnostic.....	143
13.2.1 Current Measurement Values.....	143
13.2.2 Charging History 1-Day.....	144
13.2.3 Charging History 7-Days.....	145
13.2.4 Balances.....	146
13.3 Accessing Event logs.....	147
13.4 Accessing Feed-In Management.....	149
13.4.1 Explanation of the Values in the Power Reduction Section.....	150
13.4.2 Explanation of the Symbols in the Feed-in power (% DC) column:.....	153
13.4.3 Explanation of the Values in the Reactive Power Reduction Section.....	153
13.4.4 Feed-balance section.....	156
13.4.5 PM History section.....	157
13.5 Accessing components.....	158
13.5.1 RS485 Bus Analysis.....	158
13.5.2 SO Meter (only visible when connected).....	160
13.5.3 Wireless Package (only visible when activated).....	161
13.6 Access SCM Monitor (only visible when SCB installation mode / license active).....	162
13.7 Smart Energy.....	163
13.7.1 Explanations of the terms.....	163
13.7.2 History Section.....	165
13.7.3 Simulation Section.....	167
13.8 Accessing Support.....	169

14 Yield Data Menu.....170

14.1 Current values.....	170
14.1.1 Energy flow.....	172
14.1.2 Table.....	173
14.2 Production.....	174
14.2.1 Day view.....	175
14.2.2 Month view.....	177
14.2.3 Year view.....	179
14.2.4 Total view.....	180
14.3 Consumption (only when consumption meters are connected).....	181

14.4	Balances	187
14.4.1	Day balance.....	189
14.4.2	Month balance.....	190
14.4.3	Year balance.....	191
14.4.4	Total balance.....	192
14.5	Sensor (only when connected)	193
15	Display Definition.....	194
15.1	Generation Display Controls.....	194
15.2	Values.....	195
15.3	Status.....	196
15.4	Configuration	197
15.5	Installation	198
15.6	QR Code	199
15.7	Solar-Log Base LEDs	200
16	Faults	201
16.1	Error messages.....	201
16.1.1	Fault messages time	201
16.1.2	Fault messages Internet.....	201
16.1.3	Portal Transfer Fault messages.....	202
17	Cleaning and care.....	203
17.1	Cleaning tips	203
17.2	Care tips.....	203
18	Disposal	204
19	Appendix	205
19.1	Internet ports.....	205
19.2	Digital Interfaces	206
19.2.1	Modbus TCP	206
19.3	Live data compact – summarized (complete plant).....	207
19.3.1	Open JSON Interfaces	208
20	Dimensions	210

21	List of Figures.....	211
----	----------------------	-----

1 Introduction

This manual is intended for use by solar energy technicians and professional electricians, as well as Solar-Log Base users. The installation and commissioning of components may only to be performed by properly trained specialists. Refer to Chapter 4 "Safety information" for more information.

The wiring for the additional devices is described in detail in the [Component Installation Manual](#).

The Solar-Log™ must only be used by persons who have fully read and understood the manual before installing, operating and/or servicing the device.

Our product documentation is being constantly updated and expanded.

The current versions of the documents can be downloaded from our website:

<https://www.solar-log.com/en/support/downloads>.

The descriptions in this manual refer to firmware version 5.0.1

2 Safety information

In order to protect people, the device itself, and other equipment, please pay attention to the following before handling the product:

- the content of this manual,
- the safety information,
- the warning signs and type plates attached to the product.

Note:

All the actions described in this manual for wiring and working on the individual components must be carried out only by specially trained electricians. All repairs should only be carried out by similarly trained personnel, or by the manufacturers themselves.

Solare-Datensysteme GmbH is not liable for any personal injuries, property damages and system malfunctions and their consequences which result from not adhering to the product documentation.

2.1 Hazard Classes

The safety instructions in this document are represented with standard signs and symbols. Two classes of risk are identified, depending on their probability of occurrence and the seriousness of their consequences.

Danger



Indicates an imminently hazardous situation to life
Non-compliance with this warning can lead to severe and irreversible injuries or death

Caution



Indicates an imminently hazardous situation to people, or a risk of material damage
Non-compliance with this warning can lead to irreversible injuries or to material damage.

3 Electric current

Danger



Risk of death by electric shock if inverters are opened.

Never open the inverter housing when the inverter is connected to power.

Refer to **Switching inverters off**.

Always read the installation and safety instructions given in the manual for the corresponding inverter.

Danger



Danger of death if there is condensation in the power supply unit when started!

Condensation can occur if the power supply unit is moved directly from a cold environment to a warm environment.

Wait until the temperatures have equalized before doing this.

Caution



Damage to the electrical components in inverters and on interface cards due to electrostatic discharge.

Avoid contact with component connections and plug contacts.

Before picking up the component, ground yourself by holding the protective conductor (PE) or the unpainted part of the inverter housing.

Caution



Damage to the electrical components of the Solar-Log™ due to the wiring of the Solar-Log™!
Disconnect the Solar-Log™ from the power supply.

Caution



Risk of electric shock.

Do not use the unit if the housing of the external power supply unit is damaged. A damaged power supply unit must be replaced by one of the same type in order to avoid danger.

Caution



The Solar-Log™ may only be used indoors or enclosed spaces.

The device has the protection class IP20.

4 Package Contents and Installation

Check the package contents before proceeding to assembly and installation.

Report any damage or missing parts to the forwarding agent and dealer immediately.

The device is produced according to protection class IP20 and is intended only for installation in interior areas that are dry and dust-free.

It can be mounted on the wall (see illustration below) or on a top-hat rail (refer to the Solar-Log™ dimensions in chapter 23). Power can come from a DIN rail power supply or a 24V power supply with an adapter.

Note



Please note that a power supply is not included in the package contents.

Note



We recommend using the Solar-Log™ power supply (Art.N.: 256226).

Wall mounting

For wall mounting, extend the snap-fit tabs on the bottom of the device and attach it to the wall with suitable accessories.



Fig.: Solar-Log Base without extended snap-fit tabs



Fig.: Solar-Log Base with extended snap-fit tabs

5 Solar-Log Base Connections

5.1 Top Connections Solar-Log Base

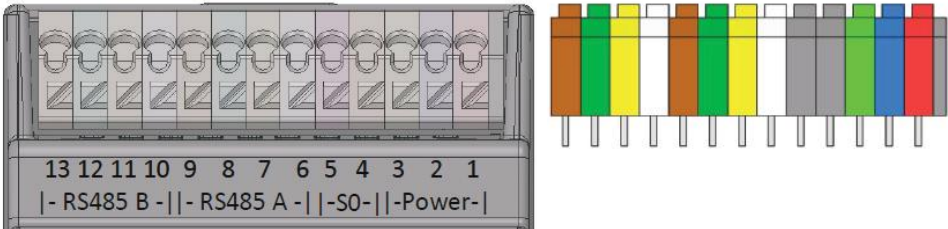

Fig.: Solar-Log Base connections - 2 x RS485 (A and B) or 1 x RS422 - colored PIN connection on the device

Solar-Log Base Top connections

2 x RS485 or 1 x RS422	Connection for accessories according to the Component Connection Manual.
------------------------	--

1 x S0	Connection for S0 meter
--------	-------------------------

1 x Power: 24 V/1A DC	Connection pins for the power supply
-----------------------	--------------------------------------

Technical Data

Nominal voltage	24 VDC +5%
Maximum cable cross-section	<ul style="list-style-type: none"> ▶ 0.14 to 1.0 mm² with ferrules. (Ferrules should be used with stranded wire.) ▶ 0.2 to 1.5 mm² with stranded wire ▶ 0.2 to 1.5 mm² with solid wire
Power consumption	< 0.5W

Note



The software automatically switches between the RS485 and the RS422 interface assignment.

Color Legend

Color	Meaning
Red	Power supply
Yellow	24 V
Blue	Ground
Olive green	Functional ground
Gray	Output or In-/output
White	Input

5.2 Solar-Log Base LEDs

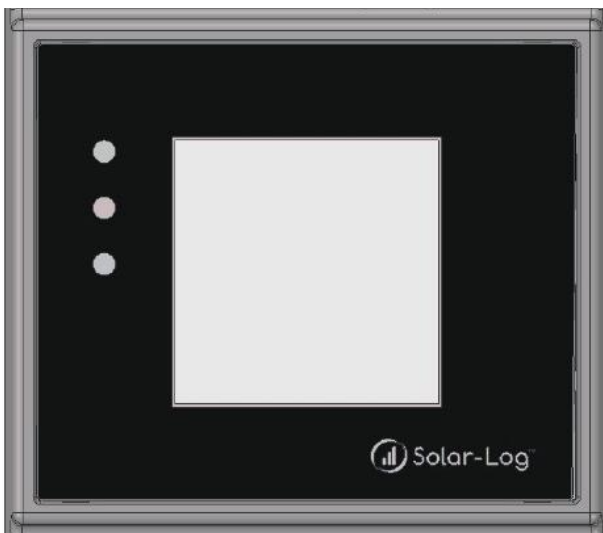

Fig.: Display with LEDs

Depending on the operating state, the LEDs can be lit up continuously in different colors.

Normal operation

Solar-Log Base - LEDs (from top to bottom)

Name	Color	Meaning
Power (top)	is green	Power supply available
Internet (middle)	is red	No Internet connection. ▶ Check the network cables.
Internet (middle)	is orange	DNS failure.
Internet (middle)	is green	Internet connection available
Components (bottom)	is red	Connection lost to at least one component.
Components (bottom)	is green	Normal operation. Connection established to the components. (The LED is also green when there is no solar irradiation, e.g. night shut-off)

5.3 Bottom Connections Solar-Log Base

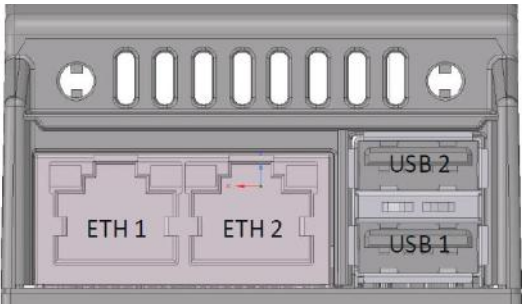

Fig.: Bottom Connections Solar-Log Base

Top of the Solar-Log Base

2 x USB	USB connection. Suitable for USB sticks. Not suitable for a connection to a PC / laptop.
2 x Network	Ethernet network interface, 10/100 Mbit 1x Internal 1x External

Note



The USB connection can only be used for USB sticks and not for a direct PC or laptop connection.

6 Connector Assignments and Wiring

The following connection cables are required as needed:

- To connect a router, you need a network cable with the appropriate length.
- If you want to connect the Solar-Log™ directly to your PC or laptop, you need to use a crossover cable.
- Cable to connect the Solar-Log™ to an inverter.
- Sets of prefabricated cables for particular inverters are available from our [Solar-Log™-Shop](#). The length of these cable sets is 3 m.
- If you want to connect several inverters to Solar-Log™, you need suitable cables and connectors to connect the inverters to each other.
- When wiring with CAT cables, the twisted pair of wires should be used.

6.1 Notes on wiring the connections

The wiring of the inverters and accessories needs to be carried out with the greatest care and attention. The most frequent source of errors when installing the Solar-Log™ is faulty wiring.

We therefore strongly recommend:

- Wiring with high quality cables.
For example: LIYCY $\geq 0.14\text{mm}^2$ or Cat 6/7 SSTP.
- Refer to the manufacturer's specifications in regard to UV resistance and mounting type when wiring in outside areas.
- A larger cable diameter is recommended for longer distances.
- Use ferrules with flexible wires
- Twist the corresponding wire pairs.
- Twist the shielding.
- Wire from PIN 1 to PIN x.
- Wire from light to dark.

6.2 General PIN Assignment

Pin assignment	Power	S ₀ IN	RS485 A/B	RS422
PIN	Assignment	-	-	-
1 (red)	V _{in} (24 V _{DC})	-	-	-
2 (blue)	Ground	-	-	-
3 (lime green)	Functional earth	-	-	-
4 (grey)	-	S ₀ IN+	-	-
5 (grey)	-	S ₀ IN-	-	-
6 (white)	-	-	Data+	T/RX+
7 (yellow)	-	-	24V	24V
8 (olive green)	-	-	GND	GND
9 (brown)	-	-	Data-	T/RX-
10 (white)	-	-	Data+	R/TX+
11 (yellow)	-	-	24V	-
12 (olive green)	-	-	GND	-
13 (brown)	-	-	Data-	R/TX-

Note



If inverters that use the RS422 connection are connected to this interface (e.g. Fronius, AEG, Riello), then it is not possible to connect accessories such as sensors or meters to this bus.

Note



The software automatically switches between the RS485 and the RS422 interface assignment.

7 Connecting the inverters

As each inverter manufacturer uses different wiring connections and connectors, the corresponding data cables must be adapted correctly.

- See Chapter 6 „Belegung und Verkabelung der Anschlüsse“ for terminal block connector wiring diagrams for the connection to the Solar-Log™
- Please refer to the Component Connection Manual when connecting inverters supported by the Solar-Log™. (Download from <https://www.solar-log.com/en/support/downloads/manuals/>)

Note



Solare Datensysteme GmbH supplies suitable connection cables for most inverter manufacturers.

Always read the manufacturer-specific instructions for connecting the data cable. You will find these instructions in the manufacturer's documentation.

However, when assigning the inverter wiring on the Solar-Log™, follow the instructions in this manual to ensure that the inverters are correctly detected by the Solar-Log™.

Danger



There is a risk of death by electric shock if inverters are opened.

Never open the inverter housing when the inverter is connected to power.

See chapter 7.1. "Switching inverters off."

Always read the installation and safety instructions given in the manual for the corresponding inverter.

7.1 Switch off the inverters and the Solar-Log Base.

Switching inverters off

Before making a cable connection between the Solar-Log and the connections inside the inverter and before installing an interface card in the inverter, always turn off all of the inverters first.

To do this, read the manufacturer's documentation for the inverter, and proceed as follows:

- Disconnect the AC side.
- Disconnect the DC side.
- Wait at least 5 minutes until the condensers in the inverters have discharged.

Switch off the the Solar-Log Base.

- Disconnect the Solar-Log Base from the power supply.

8 Connecting accessories

8.1 Sensor Box Basic and Professional

These sensors record both Irradiation sensor and module temperature values.

The solar radiation sensor must be fitted in such a way that the sensor's solar cell and the plant's modules are aligned as similarly as possible to the sun, i.e. the sensor must have the same alignment and inclination.

The sensors should be positioned in a way to best ensure that:

- as little overshadowing as possible occurs
- and snow cover does not interfere disproportionately with the sensor functions.

To achieve this, it is best to fit the sensor on the side or above the solar module. Fitting bars can normally be used as a fitting surface with modules that are parallel to the roof protrusion. In other cases, a suitable fitting support may have to be added.

Note



When using inverters with RS422 communication, do not operate the sensor on the same bus.

Wiring the Sensor Box Basic and Professional to the Solar-Log™

The wiring is done using a

- 4-wire data cable which also includes the 12 V power supply and the data connection to the Solar-Log™.
- The sensors are connected to the Solar-Log™ via the RS485 interface parallel to the inverter bus or via a free RS485 interface. Please pay attention to the notes in the component database. Sensors cannot be connected to the same bus with some inverters.
- The cable shielding must be connected with an equipotential bonding system.

A separate power supply is generally not required.

The connection cable can be extended (max. 50 m). In this case, however, it must be ensured that a power supply voltage of at least 8 V is provided for the Sensor Box Basic at the end of the cable and 10.5 V for the Sensor Box Professional. If necessary, a separate power supply can be integrated into the bus wiring.

The cable must also be suitably protected in outside areas. The cabling in inside areas can consist of a shielded data cable.

Procedure

- The four wires in the connection cable must be connected to the 4-pin terminal block connector on the Solar-Log™.
- The connection assignments are printed on the back of the sensor.

Connect the wires according to the following diagram

Important!



Replacing the connection wires may cause damage to the sensor.

Sensor Box Professional

Solar-Log Base RS485 A/B		Sensor connection cables
PIN Interface A	PIN Interface B	Assignment
6 (Data +)	10 (Data +)	Brown: Data +
7 (+24V)	11 (+24V)	Red: 24 V _{DC} (VCC)
8 (GND)	12 (GND)	Black: 0V (GND)
9 (Data -)	13 (Data -)	Orange: Data -

Installation

When the Solar-Log™ is switched on, the sensor is also automatically powered.

Then the Sensor Basic and Professional have to be configured to the desired RS485 interface:

- Select the "Mencke&Tegtmeyer" sensor via the device definition according to the device class and manufacturer.
- Define the bus.
- Perform device detection.
- The Sensor Box Basic and Professional are integrated into the system like an inverter.

8.2 Sensor Box Professional Plus

The Sensor Box Professional Plus is used to record the Irradiation from the sun. This accessory allows the Solar-Log™ to calculate the deviations in the current output compared to the potential output.

Up to 9 Sensor Box Professional Pluses can be connected to the Solar-Log™. The solar radiation sensor must be fitted in such a way that the sensor's solar cell and the plant's modules are aligned as similarly as possible to the sun, i.e. the sensor must have the same alignment and inclination.

The sensors should be positioned in a way to best ensure that:

- as little overshadowing as possible occurs
- and snow cover does not interfere disproportionately with the sensor functions.

To achieve this, it is best to fit the sensor on the side or above the solar module. Fitting bars can normally be used as a fitting surface with modules that are parallel to the roof protrusion. In other cases, a suitable fitting support may have to be added.

If there are various module alignments at a plant, every alignment should be fitted with a Sensor Box Professional Plus.

The Solar-Log™ can record and save additional environmental data with the Sensor Box Professional Plus (with optional accessories). This environmental data includes:

- Solar irradiation (integrated).
- Module temperature:
Module temperature is recorded by an integrated cell sensor, thus avoiding the costly process of mounting a sensor on the back of the module.
- Ambient temperature (optional, Article Number: 220062).
- Wind speed (optional, Article Number: 220061).

The above data form important parameters in further evaluations and analyses to measure yield.

Notes on roof mounting

The irradiation sensor is specially designed for continuous use in outside areas (IP65). The cables supplied with the Sensor Box Professional Plus are UV and weather resistant.

Recommended installation

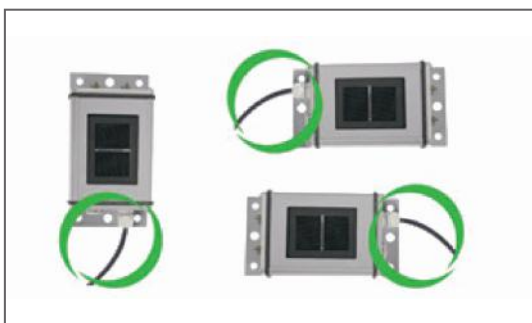

Not allowed

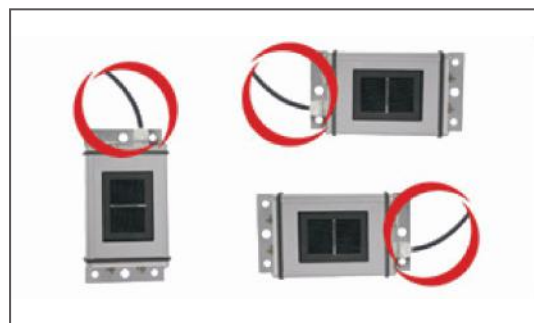

Fig.: Mounting information for the Sensor Box Professional Plus

Please note when fitting the sensor that the connection cable must be arranged as shown in the drawing.

Fitting optional sensors

The ambient temperature sensor must be fitted in a shady place with a wall bracket. The connection plug is screwed firmly into the 3 pin input on the Sensor Box Professional Plus.

It is best to install the wind sensor in a high, exposed position using the mounting bracket. The connection plug is screwed firmly into the 2 pin input on the Sensor Box Professional Plus.

Caution!



Risk of damage to the unit!
Penetrating moisture can cause short circuiting and can destroy the Sensor Box Professional Plus and Solar-Log™.

Important!



It is not necessary to open the sensor to fit it. All components are simply screwed on. If the housing is opened, water resistance and proper operation cannot be guaranteed.

Wiring the Sensor Box Professional Plus to the Solar-Log™

The Sensor Box Professional Plus can also be integrated in the bus wiring of the inverters.

Note



When using inverters with RS422 communication, do not operate the sensor on the same bus.
For inverters using RS485 communication, please check the compatibility in our [Component Database](#).

The Sensor Box Professional Plus is connected to the Solar-Log™ using the RS485 interface.

The connection cable between the Sensor Box Professional Plus and the Solar-Log™ consists of 4 wires and includes the 12 volt power supply and the data connection to the Solar-Log™.

The cable shielding must be connected with an equipotential bonding system.

A separate power supply unit is not required.

The connection cable can be extended (max. 50 m). However, an 10.5 V power supply is needed at the end of the cable. For longer stretches please select a larger cable diameter.

Procedure

- The four wires in the connection cable must be connected to the 4-pin terminal block connector on the Solar-Log™.
- Connect the wires according to the following diagram:

Important!



Replacing the connection wires may cause damage to the sensor.

Sensor Box Professional Plus

Solar-Log Base RS485 A/B		Connection cable Sensor Box Professional Plus
PIN Interface A	PIN Interface B	Assignment
6 (Data +)	10 (Data +)	Brown: Data + A
7 (+24V)	11 (+24V)	Red: 24 V _{DC}
8 (GND)	12 (GND)	Black: GND
9 (Data -)	13 (Data -)	Orange: Data - B

Installation

When the Solar-Log™ is switched on, the Sensor Box Professional Plus is also automatically powered. Then the Sensor Box Professional Plus must be configured to the desired RS485 interface:

- Select "M&T Sensor" and the corresponding bus for the initial configuration.
- Perform device detection.
- The Sensor Box Professional Plus is integrated into the system like an inverter.
- The rest of the configuration for the environmental data is carried out via the Solar-Log™'s web interface.

8.3 Large External Displays

Large external displays can be connected to the Solar-Log Base via the RS485 interface:

Cable lengths can be up to 1000 meters and the data which is displayed on the Solar-Log™ can specified.

Note



It is not possible to connect a large external display on the RS422 interface.

Note



If inverters that use the RS422 connection are connected to this interface (e.g. Fronius, AEG, Riello), then it is not possible to connect a display.

Connection via RS485 interface

Wiring for displays made by Schneider Displaytechnik

The wiring consists of a 3-pin control cable, (3 × 0.5 mm²) and terminal block connector.

Schneider Large displays

Solar-Log Base RS485 A/B		Terminal block connector Schneider Display
PIN Interface A	PIN Interface B	Assignment
6 (Data +)	10 (Data +)	A
8 (GND)	12 (GND)	GND
9 (Data -)	13 (Data -)	B

Further information about the connection can be obtained from the manufacturer of the display.

Wiring for displays from RiCo Electronic

The wiring consists of a 2-pin control cable, (2 × 0.5 mm²) and terminal block connector.

RiCo Large displays

Solar-Log Base RS485 A/B		Terminal block connector RiCo Display
PIN Interface A	PIN Interface B	Assignment
6 (Data +)	10 (Data +)	Pin 1 - Data +
9 (Data -)	13 (Data -)	Pin 2 - Data -

Further information about the connection can be obtained from the manufacturer of the display.

8.4 External Power Meter

External power meters can be connected to the Solar-Log™ via the RS-485 bus.

The energy recorded by these meters can be used for numerous applications:

- Generator: The meter values are treated as production values.
- Consumption meter: Meter that only records the consumption.
- Consumption meter (Bi-directional meter): Meter that records consumption and production collectively - the actual consumption is determined by monitoring the inverters.
- Sub-consumer: Meter to record the individual consumption from appliances that was already recorded with a primary consumption meter.
- Battery meter (bi-directional meter): Records the battery charges and discharges.
- Meter for the entire plant: The entire production from all of the inverters.
- Utility Meter (U+I): Meter for control and reduction functions - including current measurements if necessary with current transformers.
- Utility Meter (U+I) + Consumption Meter (bi-directional) Meters that are used as Utility Meters (U+I) can also be used as consumption meters (bi-directional) in this mode.
- Utility Meter (U): Meter for control and reduction functions - only voltage measurements.

Note



We recommend using the meters that we have tested and offer.
We cannot guarantee the functionality of other products.

Note



Refer to the Meter Connection Manual for all of the supported meters and their wiring diagram. Download it from our website:
<https://www.solar-log.com/en/support/downloads/manuals/>

8.4.1 External power meters/accumulating meters

With multiple phase meters, a basic distinction is made between phase-exact and accumulating meters. Accumulating meters provide the total values from all three phases. The meter calculates the total output (also to and from the grid) of the individual phases and provides this total as a single value.

In the example:

Phase 1 supplies 3 kW via an inverter (single phase).

Phase 2 draws 2 kW (energy)

Phase 3 draws 1 kW (energy)

With an accumulating meter, this results in a total of 0 kW.

Examples of accumulating meters are the Janitza UMG 104/UMG 604 and the Solar-Log™ Pro380-Mod.

8.5 Wiring for RS485 meter

The meter's RS485 output can be connected to any RS485 interface on the Solar-Log Base.

Overview

- 2-pin wiring.
- The communication address does not have to be assigned.

Installation steps

- Switch off the inverters and the Solar-Log™.
- Connect the meter to the Solar-Log™.

The wiring is done using a self-made, shielded 2-wire data cable and a 4-pin or 6-pin terminal block connector.

Procedure

- Connect the wires for the connecting line as shown in the following diagram.

Wiring for RS485 meter

Solar-Log Base RS485 A/B		Inepro 75D terminal block connector <small>Article number: 255420</small>	Inepro 1250D terminal block connector <small>Article number: 255421</small>	Utility meter terminal strip <small>Article Number: 255385</small>
PIN Interface A	PIN Interface B	PIN	PIN	PIN
6 (Data+)	10 (Data +)	8 - 485A	11 - 485A	22
9 (Data-)	13 (Data -)	7 - 485B	10 - 485B	23

- Insert the terminal block connector into the Solar-Log™ RS485 A, RS485/422 B or RS485/422 C socket.
- Perform a device detection: The power meter is connected to the system as if it were an inverter.
- Configure the power meter functions under [Configuration | Device | Configuration](#).
 - Generator
 - Total yield meter
 - Consumption Meter
 - Utility Meter (U) (only Solar-Log 2000)
 - Utility Meter (U+I) (only Solar-Log 2000)
 - Utility Meter (U+I) + Consumption meter (bi-directional) (only Solar-Log 2000):
 - Sub-consumer

Note



Only one Inepro RS 485 meter can be used for each Solar-Log Base interface.

Note



These meters cannot be used together at the same bus input with inverters that are connected to RS422 (e.g. Fronius).

Note

Inepro
1250D



All three phases have to be connected for the Solar-Log™ to accurately detect the meter.

If an Inepro 1250D is used, the PRG button on the meter must be pressed and held down during entire detection process.

If it is not possible to hold down the PRG button during the whole process, we recommend provisionally connecting the meter to the Solar-Log™ with a short cable after the installation in order to be able to press and hold down the PRG button.

In a second detection attempt with the inverter, the meter is then detected by the Solar-Log™ even if the PRG button is not pressed.

The detection of an Inepro 1250D in an existing installation can take up to 15 minutes. After the detection, a restructuring of the data takes place which can take up to 45 minutes depending on the amount of data on the devices.

Note
Inepro
meter



Inepro meters are automatically given the mod bus address 234 by Solar-Log™ during the detection process.

This address is therefore not allowed to be used for other devices.

After the configuration the display on the Inepro meters alternates between the meter status and the address display (ID=EA); this is how you know if Solar Log™ has made the correct detection.

All RS485 meters have to be terminated with an 120Ω resistor between the two pins used.

8.6 Installation Utility Meter / Janitza UMG 104 / UMG 604 (only Solar-Log

Base 2000)

The Solar-Log™ Utility Meter is a universal metering device. It can be integrated in both low- and medium-voltage networks (via a transformer) and is needed for various functions:

- controlling voltage-dependent reactive power via the Q(U) function
- controlling reactive power at the feeding point
- recording the measurement data needed for the response signals sent to the grid operator

Only the voltage measurements are needed to control voltage-dependent reactive power via the Q(U) function (Although, it is still recommended to perform voltage and current measurements to check that the reduction function is operating properly). Current and voltage measurements are needed for the other functions.

The previous chapter explains how to wire the Utility Meter to the Solar-Log™. This chapter deals with connecting the Utility Meter for measurements in low- and medium-voltage power grids.

Utility Meter supply voltage / Janitza UMG 104 / UMG 604:

- 95-240Vac, 45-65Hz or 135-340Vdc.

The Utility Meter's measuring inputs have the following limits:

- Voltage line conductor AC (without a voltage transformer): 10...300 V AC.
- Voltage phase AC (without a voltage transformer): 17...520 V AC.
- Current (without a current transformer) 0.005, 7.5 A
- Frequency of the fundamental component: 45 ..65 Hz.

The limit may not be exceeded. For this reason, a measuring transformer needs to be installed for most applications.

We recommend the following transformer ratio:

- Voltage: Secondary 100V
e.g. at 20kV grid converter 20000:100V.
- Current: Secondary 5A
e.g. 100:5A.

Note



The Utility Meter that we use is produced by the company Janitza.

Refer to the Janitza UMG 104 / UMG 604 manual for further technical details.

We cannot guarantee the functionality of other Janitza devices.

- ▶ The operating modes Utility Meter (U / U+I) are only possible with the Solar-Log 1900 and 2000.

Note



The Utility Meter cannot be connected to the inverters with a single bus. For this reason, use one RS485 connection for the inverters and one RS485 connection for the Utility Meter.

8.6.1 Connecting the Utility Meter to the power grid

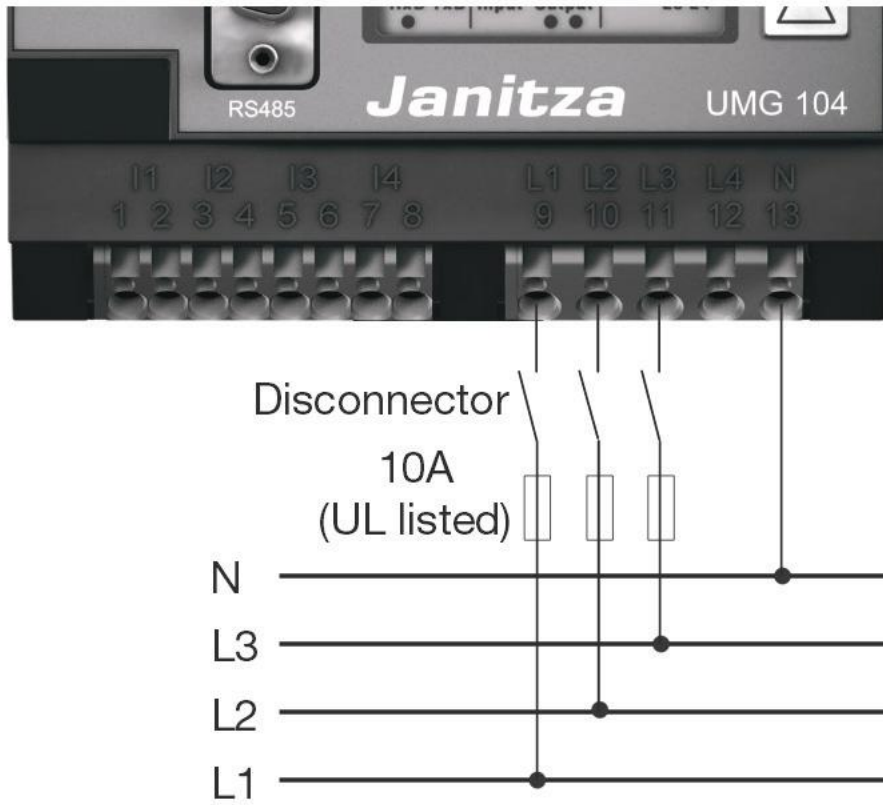

Fig.: Utility Meter connection diagram for voltage measurements in low-voltage power grids

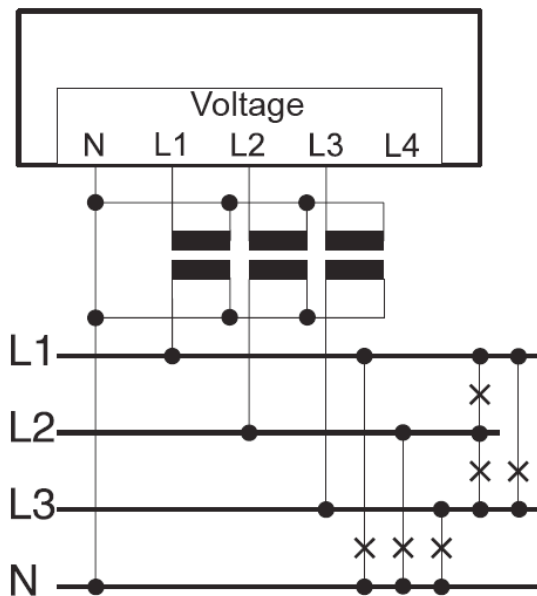

Fig.: Utility Meter connection diagram for voltage measurements with current transformers (medium voltage)

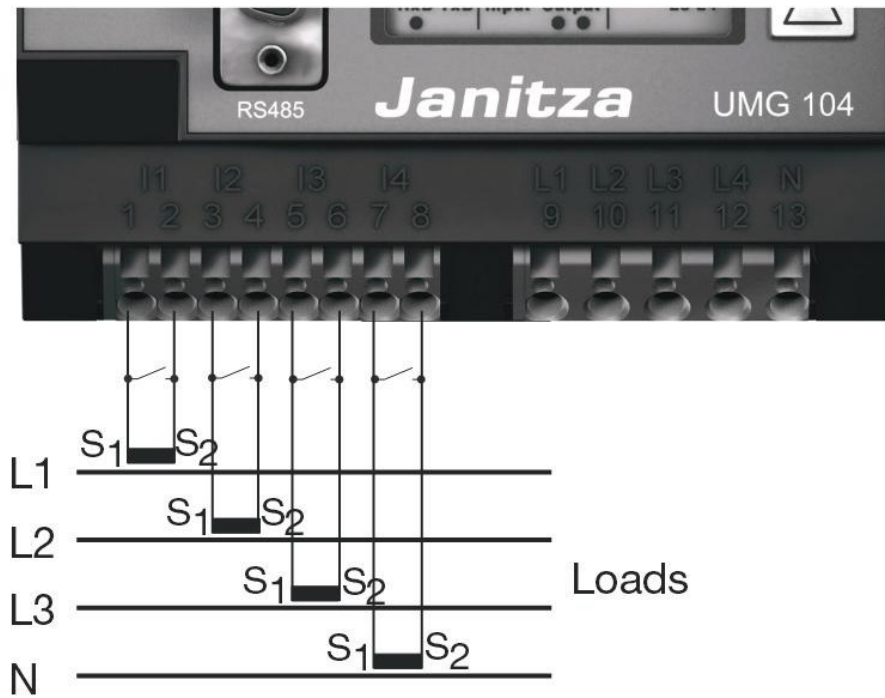

Fig.: Utility Meter connection diagram for current measurements with current transformers

Procedure

- Enter the supply voltage into the Utility Meter

Note



We recommend using a fuse to safeguard the connection lines for the supply voltage. Please follow the instructions in the Janitza UMG 104 / UMG 604 manual.

Note



Supply voltages that do not correspond to the specifications on the rating plate can cause malfunctions and damage the device.

Important!



The inputs for the supply voltage are dangerous to touch.

- Connect the measurement lines for current and/or voltage to the bottom of the Utility Meter.

Note



The measurement voltage must in effect be at least 10V or an exact measurement is not possible.

- Connect the Utility Meter to the RS485 bus of the Solar-Log™ according to the following diagram:

Wiring the Utility Meter

Solar-Log Base RS485 A/B

Utility meter Terminal block connector

Article Number: 255385

PIN Interface A

PIN Interface B

PIN

6 (Data+)

10 (Data +)

22

9 (Data-)

13 (Data -)

23

- The RS485 bus must be terminated.
Install a 120 Ohm, 0.25 W resistor between pin 22 and 23 of the Utility Meter to terminate.
- Configuring the Utility Meter from the display.
Setting MODBUS Address (PRG 200 = 1).
Setting Baud rate RS485 (PRG 202 = 2).
Setting Mode (PRG 203 = 0).
Setting Current converter primary (PRG 000).
Setting Current converter secondary (PRG 001).
Setting Voltage converter primary (PRG 002).
Setting Voltage converter secondary (PRG 003).
Refer to the accompanying manual of the device for the UMG 104 configuration procedure.

Note



The parameter settings need to be adjusted before the device detection.
If the parameters differ, the Utility Meter will not be detected by the Solar-Log™.

- Perform a device detection:
Refer to the Chapter "[Device Detection](#)."
- Configure the Utility-Meter under [Configuration | Devices | Configuration](#), select the corresponding [Operating mode](#) and click on [Save](#).

Check

- Does the Utility Meter display a positive value for inverters feeding power, the current output (kW)?
If this is not the case, the current measurements are incorrectly connected.
If necessary, switch the polarity of measuring inputs.

Note



When replacing the polarity, the cable must not be energized, since the converter can be destroyed otherwise.

8.7 Solar-Log™ Smart Relay Box

The Smart Relay Box makes it possible to switch 8 relays via the Smart Energy control logic depending on the current production (surplus).

The Relay Box has:

- 4 inverter contacts
- 4 make contacts

Characteristics of the relays:

Maximum current load:

0.5 A @ 120 V_{AC}

0.25 A @ 240 V_{AC}

1 A @ 30V_{DC}

0.3 A @ 110V_{DC}

Procedure:

- Connect the Relay Box to the RS485 bus of the Solar-Log™ according to the following diagram:

Relay Box Wiring

Solar-Log Base RS485 A/B

Relay Box Terminal block connector

Article Number: 255656

PIN Interface A

PIN Interface B

PIN

6 (Data+)

10 (Data +)

Data + (Y)

9 (Data-)

13 (Data -)

Data - (G)

- Device detection is not necessary for this device.
- The device only has to be selected from the [Configuration | Smart Energy](#) menu to be activated.
- The power comes from the top-hat-rail power supply that was included with the Relay Box.

Note



The Relay Box has to be defined and activated as a switch in the [Configuration | Devices | Definition | Interfaces](#) with the plus symbol to be able to configure it.

Note



The Solar-Log™ Smart Relay Box cannot be connected together with inverters on an RS485 interface. The Relay Box requires its own separate RS485 bus. It is possible to combine the Utility Meter with sensors.

8.8 WeMo Insight Switch

With the WeMo Insight Switch, home appliances and electronic devices can be connected to a Wi-Fi network, allowing the devices to be remotely turned on and off. The Wemo Insight Switch can also monitor the devices and will send information about the device's energy usage directly to your smartphone or tablet. Follow the subsequent instructions to be able to use these functions with the Solar-Log™.

Procedure:

1. Connect a desktop/laptop and the Solar-Log™ to the router with a LAN cable.
2. Download the WeMo app to your smartphone or tablet.
3. Reset the WeMo Insight Switch (press the reset button for 5 seconds while turning on the power for the WeMo Insight Switch).
4. The WeMo searches for the smartphone or tablet via WiFi.
5. Start the WeMe app and connect the WeMo Insight Switch to the router's WiFi network.
6. Connect to the Solar-Log Base's WEB interface with the desktop/laptop and go to the [Configuration | Devices | Definition](#) menu.
7. Select the device class "Switch" with the +plus button.
8. Select "Belkin" as the manufacturer and "WeMo Insight" as the type. Enter the number of devices and click on save.
9. Then start the device detection from the [Configuration | Devices | Detection](#) menu.
10. The connection is now established.

The last step is configuring the Smart Energy Logics. Refer to the Solar-Log™ Smart Energy Manual for more information. It is available from our website

<https://www.solar-log.com/en/support/downloads/manuals/>

8.9 Allnet Network Power Socket

Allnet network power sockets can switch connect electronic devices on and off. These switching operations can be set manual, time-controlled or based on consumption levels. Allnet network power sockets can be integrated into the local network with a LAN cable connection. Follow the following steps to be able to use these functions with the Solar-Log™:

Procedure:

1. Connect the Allnet socket to a laptop or PC with a LAN cable and plug the Allnet device into a power socket.
2. Click on Control Panel
3. and then go to the Network and Sharing Center (for other operating systems, refer to the instructions for setting the IP address).
4. Click on Local Area Connection to open the Status window and then click on Properties.
5. Select the Internet Protocol Version 4 (TCP/IPv4) and then click on Properties

Important!

Note the displayed values before you change them because you will need them again later.

6. Adjust the displayed values as follows (using the following IP address):
IP address: 192.168.0.101
Subnet mask: 255.255.255.0
Gateway: 0.0.0.0
Confirm the settings with "OK."
7. Enter the IP address 192.168.0.100 as the URL in your browser to access the Allnet menu.
8. Click on settings and go to [Configuration | LAN Settings](#).
9. Configure a separate IP address for every Allnet network power socket. The new IP address need to match the range for the existing network (refer to your computer's original settings).
For example, if our computer's original IP address was 192.168.178.2 and the next address is free, the Allnet network power sockets would start with 192.168.178.3 and continue. The Subnet mask is 255.255.255.0 by default and must be the same for every device in the subnet. The gateway is typically the IP address of the router or switch to which the computer is connected again later. Save the settings when they are completed.
10. After adjusting the networks settings for the network power sockets, change the values for your computer's networking settings back to the original values.
11. The configuration is then finished.

Note



To ensure functionality with the Solar-Log Base, the ALL3075v3 still has to be set to remote control in the Allnet socket configuration.

8.9.1 Connecting the Allnet network power socket to the Solar-Log Base

The Allnet socket has to be defined with the device detection function to connect to the Solar-Log Base. From the WEB interface of the Solar-Log Base go to [Configuration | Devices | Definition](#) and select the device class "Switch" with the blue plus symbol and then Allnet as the manufacturer followed by the type and number of devices. Confirm the selection with **OK** and start the detection from the [Configuration | Devices | Detection](#) menu. Let the detection process run completely. After that, select the corresponding devices from the [Configuration | Devices | Configuration](#) menu, enter the IP address and perform the rest of the setup. Click on save once everything is finished.

The last step is configuring the Smart Energy Logics. Refer to the Solar-Log™ Smart Energy Manual for more information. It is available from our website

<https://www.solar-log.com/en/support/downloads/>.

9 Other connections

9.1 USB

The Solar-Log Base comes with two USB connections. This USB connection can only be used for USB sticks and not, for example, for a direct PC or laptop connection.

Note



When a USB stick is connected, the Solar-Log™ automatically saves a backup in the backup folder. A maximum of 10 backup files are saved in the directory. Older backup files are automatically deleted.

The backup is saved on the USB stick in the directory /Backup with the following file names:

- solarlog_backup_YYMMDD.dat:
YYMMDD = year, month and day - each two digits, e.g.
190825 is then 25 August 2019.

10 Installation

The Solar-Log Base has an integrated web server, which contains all the software necessary for operation and configuration.

No additional software needs to be installed on the PC to access the Solar-Log Base.

A common web browser with JavaScript enabled is required.

We recommend using the current version of Mozilla's Firefox, Google's Chrome or Microsoft's Edge.

To run the web browser, a network connection is required between the PC or laptop and Solar-Log Base, and Solar-Log Base must be up and running. It is required to have the DHCP server enabled on the router.

10.1 Connect the Solar-Log Base to a network / PC.

The Solar-Log Base is equipped with two standard Ethernet RJ45 sockets, which can be connected through any commercially available network cable. Speeds of 10 Mbit and 100 Mbit are supported.

In general, any PC networking technology can be used for connecting the Solar-Log Base. The following technologies are available:

- Connection through an Internet router:
Ethernet RJ45 network cable.
- Direct cable connection from the PC to the Solar-Log Base:
Ethernet RJ45 network patch cable.

If the Solar-Log Base is operated via a router, ensure that the necessary ports have been activated (see Chapter „Internet-Ports“).

Note



The Solar-Log Base has DHCP activated by default to be able to establish a connection when connected to a router with its DHCP server enabled.

10.2 Initial set up of the Solar-Log Base

The complete configuration of the Solar-Log Base can be done via the PC/laptop or via a tablet or smartphone.

Requirements

- All cables and accessories (if any) have been connected to the Solar-Log™.
 - The Solar-Log Base is connected to an Internet router.
 - The DHCP server is enabled on the Internet router.
- or
- The DHCP server is enabled when connecting directly to the Solar-Log Base with a PC.
(We recommend using a patch cable.)

11 Go to the Main Menu.

The various options to open the main menu of the Solar-Log Base are listed below:

Device URL

- Start the web browser.
- Enter `http://solar-log` in the address bar and press the ENTER key.
- The main menu of the Solar-Log™ is displayed.

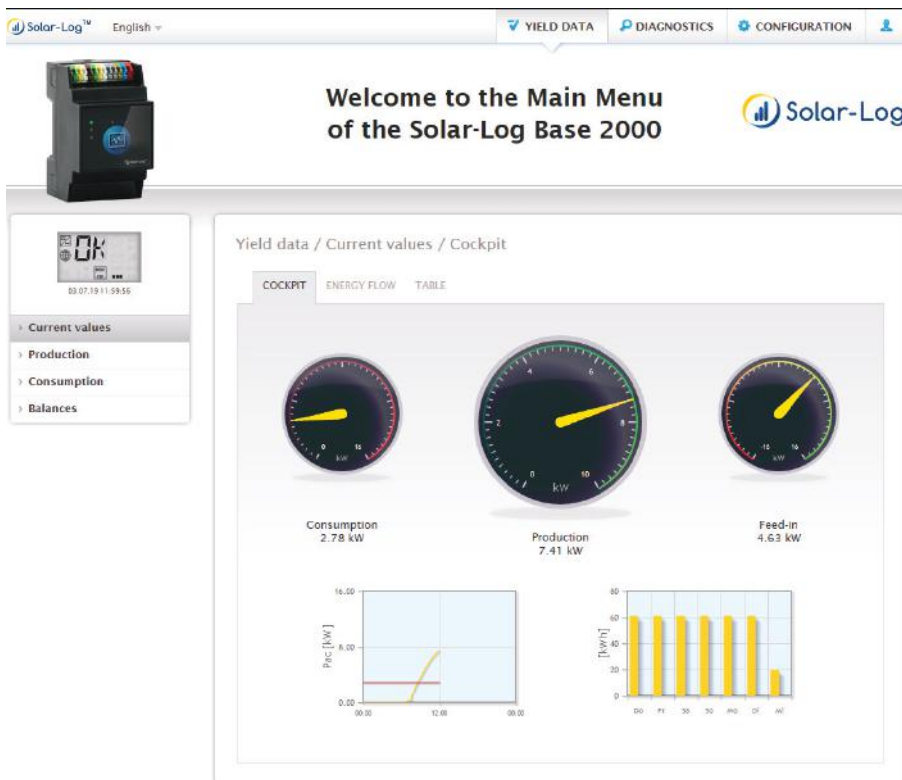

Fig.: Main menu of the Solar-Log Base 2000

Alternatively, the Solar-Log™ can also be accessed as follows:

IP address from an automatic IP range:

- Start the web browser.
- Enter `http://169.254.wx.yz` in the address bar and press the ENTER key:
Here wxyz stands for the last 4 digits from serial number of the Solar-Log Base. The serial number is located on the service (see left device side).
- The main menu of the Solar-Log Base is displayed.

IP address that was entered during the initial configuration

- Start the web browser.
- Enter IP address from the [Initial Configuration](#) in the address bar and press the ENTER key.
- The main menu of the Solar-Log Base is displayed.

Go to the Main Menu.

Device URL when there are several Solar-Log™ devices on the network

- Start the web browser.
- Enter `http://solar-log-wxyz` in the address bar and press the ENTER key:
Here wxyz stands for the last 4 digits from serial number of the Solar-Log Base.
The serial number is located on the service (see left device side).
- The main menu of the Solar-Log Base is displayed.

Note



All Apple user have to use "169.254.wx.yz" to access the Solar-Log Base.

Define the password.

If no password has been defined, the a security notice is displayed in the following window.



Fig.: Pop-up window with security information

Click on "Yes" here to directly define a user password. The following configuration page appears:

Configuration / System / Access control

ACCESS CONTROL HTTPS LANGUAGE/COUNTRY/TIME LICENCES FIRMWARE

Browser access control

Password required for user access Deactivated

User password

Repetition

Password required for installer access Deactivated

Installer password

Repetition

Password required for installer/PM access Deactivated

Installer password

Repetition

Public JSON interface

Activate Activated

CANCEL SAVE

Fig.: Configuration page "Access control"

In the Access protection for the browser section, the user password can be activated and defined. Click on "save" after the defining the password.

Set password later (not recommended)

It is possible to define the user password later by clicking on "No" or by clicking on "No" after checking the box "I am aware of the security risks." Close the "Do not show this dialog automatically any more" window. Check this box to skip this dialog. Otherwise, the security warning opens each time the web interface is accessed.

As a reminder to define a password, a small red triangle appears in the top right corner. Click on this icon at any time to define the user password. Once a password has been defined, the triangle disappears.

Go to the Main Menu.

11.1 Operating the Main Menu of the Solar-Log Base

The main menu of the Solar-Log Base functions like a website and is divided into four main sections:

- Header bar (A)
- Left navigation (B)
- Tab (C)
- Configuration page (D)

Various control elements are used. (See the explanation below).

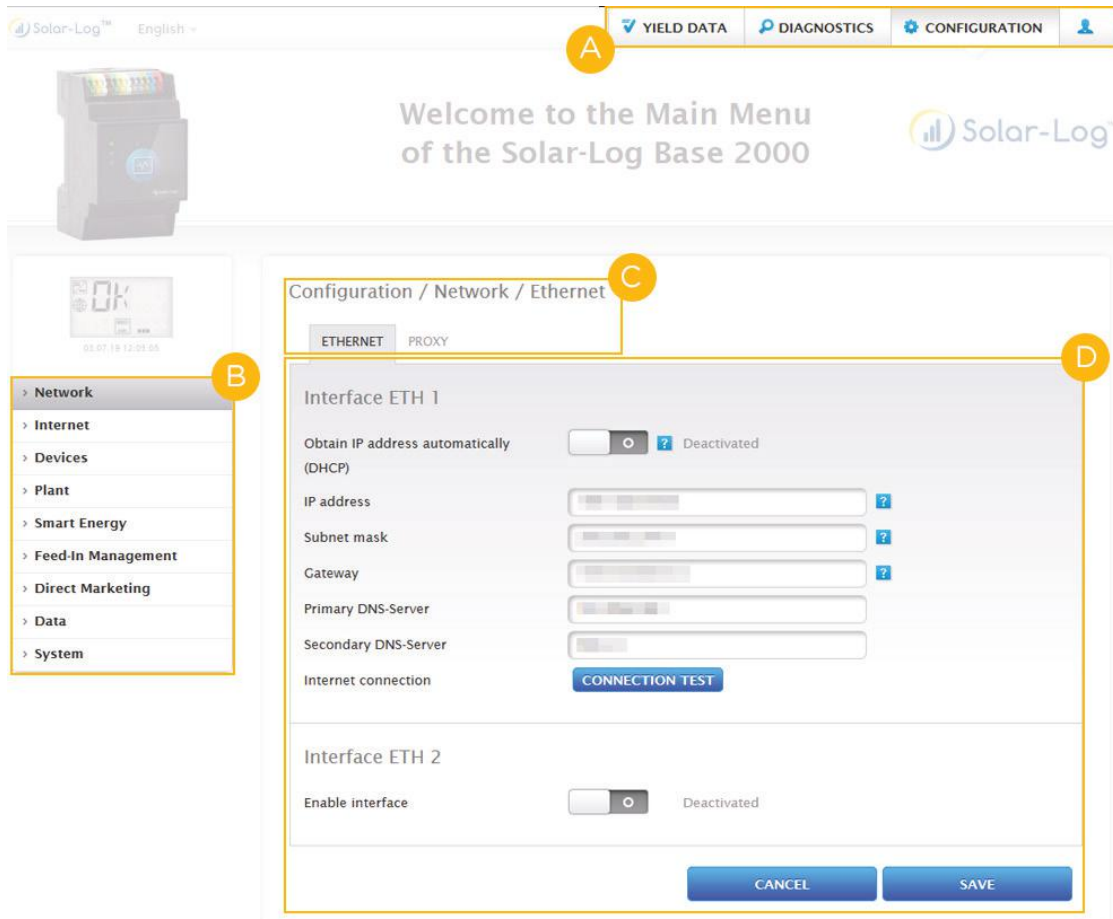

Fig.: Structure of the Solar-Log Base's Main Menu

11.1.1 Control elements

The following control elements are used:

Control elements







Control element	Meaning
	Text field
	Text field with incorrect or missing entry.
	Drop-down selection list
	Switch deactivated and activated
	The question mark boxes display additional information
	Check boxes Several boxes can be selected at one time
	Command buttons for various functions

Fig.: Control elements

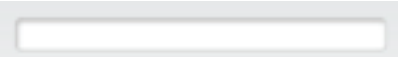
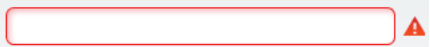
11.2 Explanations of the names in the main menu.

11.2.1 Header bar

The header contains four main sections:

- **Login symbol (👤):**
Clicking on the login symbol, for example, allows you to access the info center or assistant.
- **Configuration:**
Here you can change the device settings as required.
- **Diagnostics:**
Diagnostics allows you to view a summary of the device information and to create a diagnostic report.
- **Yield data:**
Yield data allows you to view the current plant yields and the system information.

Note



All of the points are described below in the chapters:

- Login Section Menu
- Configuration Menu
- Diagnostics Menu
- Yield Data Menu.

11.2.2 Left-side navigation menu

Depending on the tab selected, you can access additional functions from the navigation menu (left-side).

Tabs

Additional configuration sections appear according to the function selected.

11.2.3 Configuration Page

Here you have the option to make any necessary modifications to the configuration, to create back or to reset the device.

11.2.4 Login Section Menu

You can enter a password protected section by clicking on the log in button (to the right of the confirmation in the web interface) and entering your user and password. There is a gray line below the login button that indicates if you are logged in and with which user level. (Refer to the [Access Control](#) section for more information)

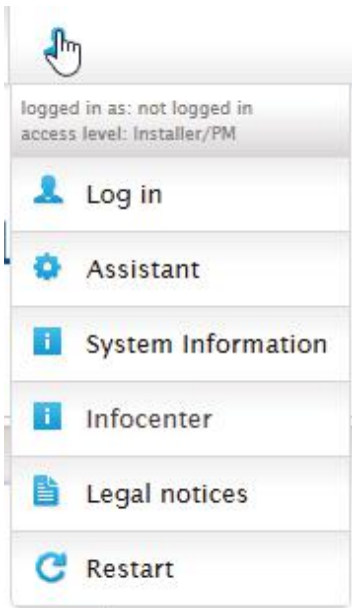

Fig.: Log in button with selection box

Additional points below the login symbol:

- Assistant
- System Information
- Info Center
- Important Legal Information
- Restart

Assistant

The configuration wizard can be started directly from here.

System Information

The following information can be viewed from system information:

About the Solar-Log™:

- Model
- Serial number
- Firmware version

Plant data:

- Plant size

Detected devices (depending on what devices are connected):

- Battery
- Hybrid System
- Sensor
- Inverter
- Meter

Go to the Main Menu.

Data transfers:

- Last transfer with the time and date and state message (in the example: OK)

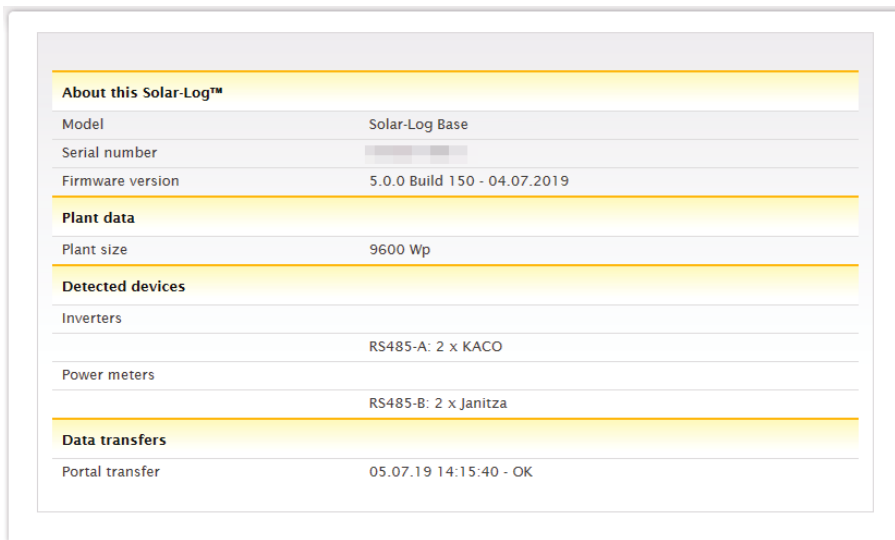

About this Solar-Log™	
Model	Solar-Log Base
Serial number	
Firmware version	5.0.0 Build 150 - 04.07.2019
Plant data	
Plant size	9600 Wp
Detected devices	
Inverters	RS485-A: 2 x KACO
Power meters	RS485-B: 2 x Janitza
Data transfers	
Portal transfer	05.07.19 14:15:40 - OK

Fig.: System Info with example plant

Info Center

Information on the following sections can be accessed here:

- Solar-Log™:
The information about the Solar-Log™ such as the serial number, Easy Code and MAC address is located here.
- Solar-Log WEB-Enerest™:
Here the domain, transfer type, last transfer and ordered package can be viewed.
- Documentation:

This allows you to access the relevant manuals and download them if necessary or to search the component database.

- Firmware & Support:
Here you can access, for example, the website, support contact form and FAQs.
- Solar-Log™ Shop:
Here you can, for example, go to the Solar-Log™ Shop for accessories or licenses.

Important Legal Information

The legal information indications that this product uses open source components. In addition, a list of these components is displayed with the respective license texts.

Restart

This function resets the device.

11.2.5 Hide arrow

The "Hide Arrow" (on the right of the header bar) allows you to increase the amount of the page displayed in the browser by hiding the Welcome header.



Fig.: Header bar with the "Hide Arrow"

11.2.6 New Firmware

A notification is sent via the web browser when a new firmware is version available; a green triangle with an exclamation mark is displayed at the top in the status line. (See illustration: Signal for new firmware)



Fig.: Signal for new firmware

Note



The [Automatic Firmware Update Check](#) has to be activated in the [Configuration | System | Firmware](#) menu to use this function. (See illustration: Automatic Firmware Update Check with notification text displayed)

Go to the Main Menu.

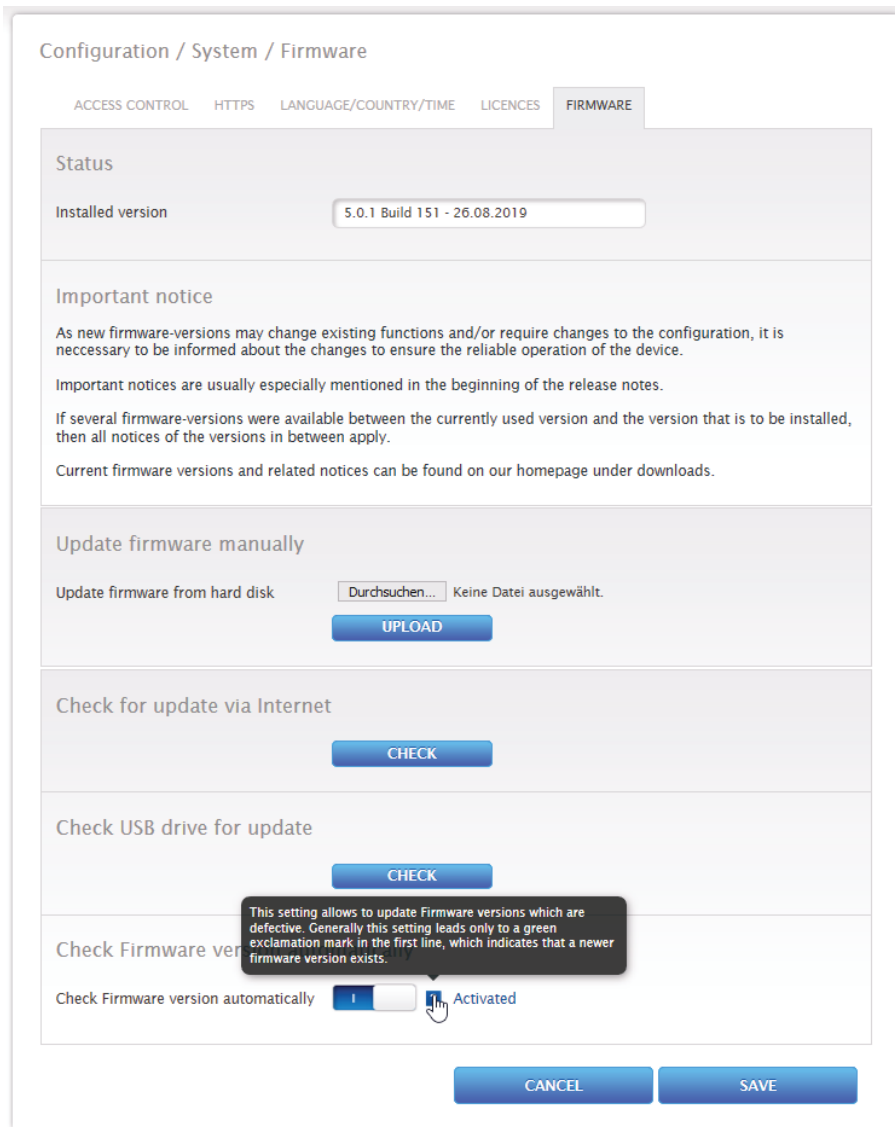

Fig.: Automatic Firmware Update Check with notification text displayed

The following notification text is displayed by clicking on the question mark:

"This settings allows firmware versions with critical errors to be automatically updated. However, generally, this setting only indicates that a new firmware version is available (green exclamation mark at the top).

When clicking on the green exclamation mark in the header bar, a window with the new firmware version will appear.

Selecting "OK" redirects you to the page of the Solar-Log Base for firmware updates. Selecting "Cancel" closes the window.

11.2.7 Installation Mode

The installation mode is used for a smooth initial installation and configuration without having import licenses right away. The installation mode is valid for 30 days and is automatically activated when using a function that requires a license. The installation mode is indicated with a blue information symbol in the top-right corner of the header. Move the mouse cursor above the symbol to see how long the mode is still valid. Click on the symbol to go to the License menu. The menu can also display which licenses are currently active. It can also be accessed from [Configuration | System | Licenses](#)). Once the valid period has been passed, the installation mode becomes inactive. The Installation Licenses are grayed out in the Licenses menu and no longer displayed after 10 days.

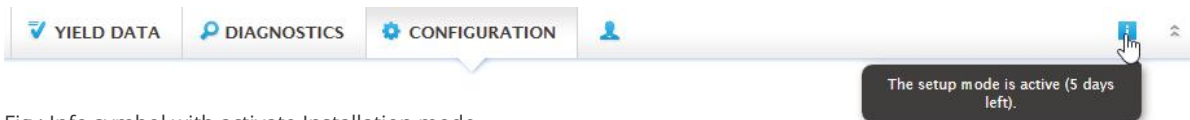

Fig.: Info symbol with activate Installation mode

Inactive Installation Mode

The installation mode becomes inactive 31 days after the initial installation and the licenses lose their validity. As a result, restrictions occur, such as no transmission of the recorded measured values via FTPS and graphics are blocked on the local web interface. The licenses can also be viewed from the Licenses menu ([Configuration | System | Licenses](#)).

Note



If a driver license needs to be purchased, this is indicated with the information symbol and information text under the Interface Assignment Definition (Device Detection) when adding components.

Required Licenses

These licenses need to be purchased in order to operate without any limitations. The required licenses can be displayed, forwarded and edited in various forms in the tab. The required licenses are displayed with a red triangle next to the blue information symbol in the header (see illustration).

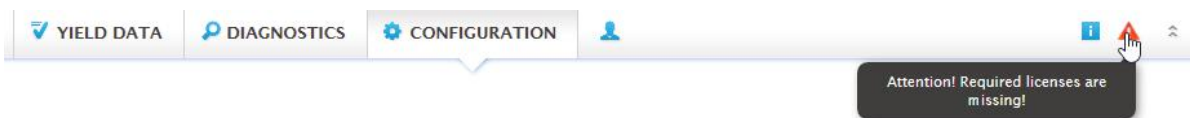

Fig.: Red triangle with information text

Click on the red triangle to go to the [Licenses](#) menu. This menu displays the licenses that need to be purchased in order to operate without any limitations. (see illustration)

Go to the Main Menu.

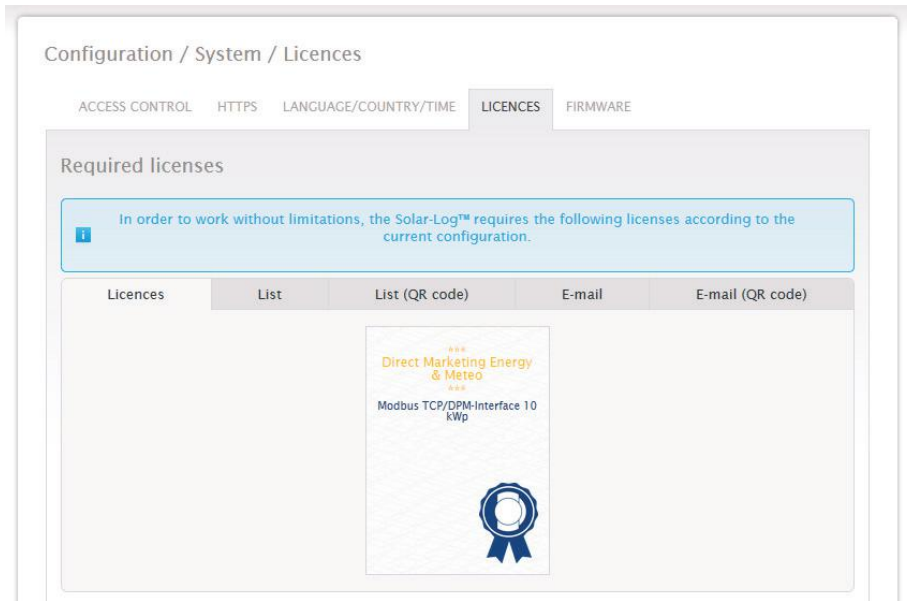

Fig.: "Licences" menu with the "Required Licenses" section (example)

The required licenses can be displayed, forwarded and edited in various form in the tab.

Licences:

The required licenses are displayed in tiled form.

List:

This function displays the required licenses in text form which can be saved in a file.

List (QR Code):

The QR code list allows the required license list to be transfer to a smartphone app.

E-Mail:

This menu allows the required licenses to be sent as a text list with the e-mail client.

E-mail (QR Code):

This menu allows the required licenses to be sent as a QR code list with the e-mail client, which can be used by a smartphone app.

Note!



A QR code scanner has to be installed on the smartphone in order to read the QR code license list.

Refer to the chapter 12.16.4 "Licences" on how to purchase and install licenses.

11.3 Setting up of the Solar-Log™ with the configuration assistant

After the initial set up of the Solar-Log™, the Solar-Log™ starts to ask about the following settings:

- Language
- Country, Time, Set Time automatically (via NTP server)
- Display access control

At the end, a pop-up window appears where you can start the Solar-Log™ configuration wizard. (Refer to the following image: "Startup screen of the Solar-Log™ configuration wizard").

At this point, if you do not want to continue with the setup, the configuration wizard can be stopped by clicking on the "Cancel" button. After clicking on "Cancel," the local "Cockpit" WEB page is started. The setup can be done manually from this menu. The Solar-Log™ configuration wizard can be started at anytime by clicking on Assistant under the Login Symbol. (see illustration)

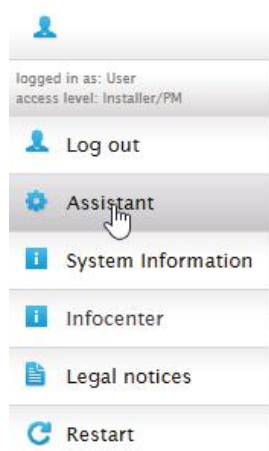

Fig.: Login symbol with selected assistant

Note



The configuration assistant can be stopped at any time by clicking on the "Cancel" button (left below the progress bar). The previously entered settings remain active.

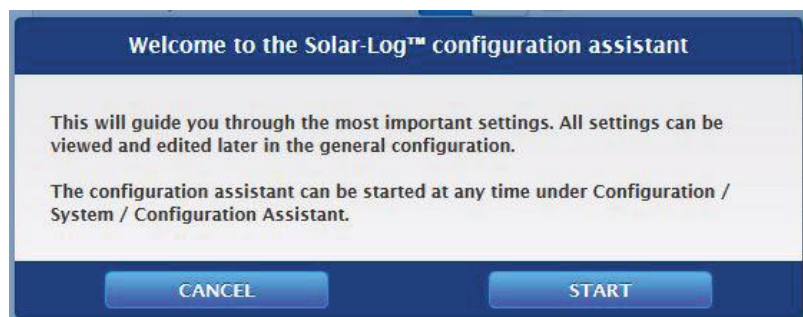

Fig.: Startup screen of the Solar-Log™ configuration wizard

Go to the Main Menu.

Click on the "Start" button to run the configuration wizard. Once started, the [Ethernet Settings](#) menu appears (see image "Solar-Log™ Ethernet Settings").

Here there is the option to activate a second Ethernet interface in order to separate the IT network from the PV plant.

Since the Solar-Log™ has DHCP (obtain IP address automatically) active by default, check whether the DHCP server has been activated on the router. If the DHCP server is disabled in the router, the network settings must be configured manually. If necessary, please consult a network specialist who can assign a suitable network address in regard to IP address, Subnet mask and Gateway, for example.

If the Solar-Log™ is to have a [fixed IP address](#), the [Obtain IP address automatically](#) (DHCP) switch needs to be [deactivated](#).

The following fields need to be adjusted according the network's configurations.

[IP address](#)

The address needs to be entered manually in order to allow remote PC access, when using a direct PC connection or a router without DHCP service.

[Subnet mask](#)

The Subnet mask is 255.255.255.0 by default and must be the same for every device in the subnet.

[Gateway](#)

The gateway is typically the IP address of the router to which Solar-Log™ is connected. That IP address is to be entered here.

[Primary DNS server](#)

In some networks, the DNS server is a separate address for resolving Internet addresses (unlike a gateway). In this case, the IP address of the DNS server is entered here.

[Secondary DNS server](#)

Enter a secondary DNS server here if it is required for the network. The secondary DNS server is used to resolve Internet address names when the primary DNS server is not available.

Once finished, click on [Save](#).

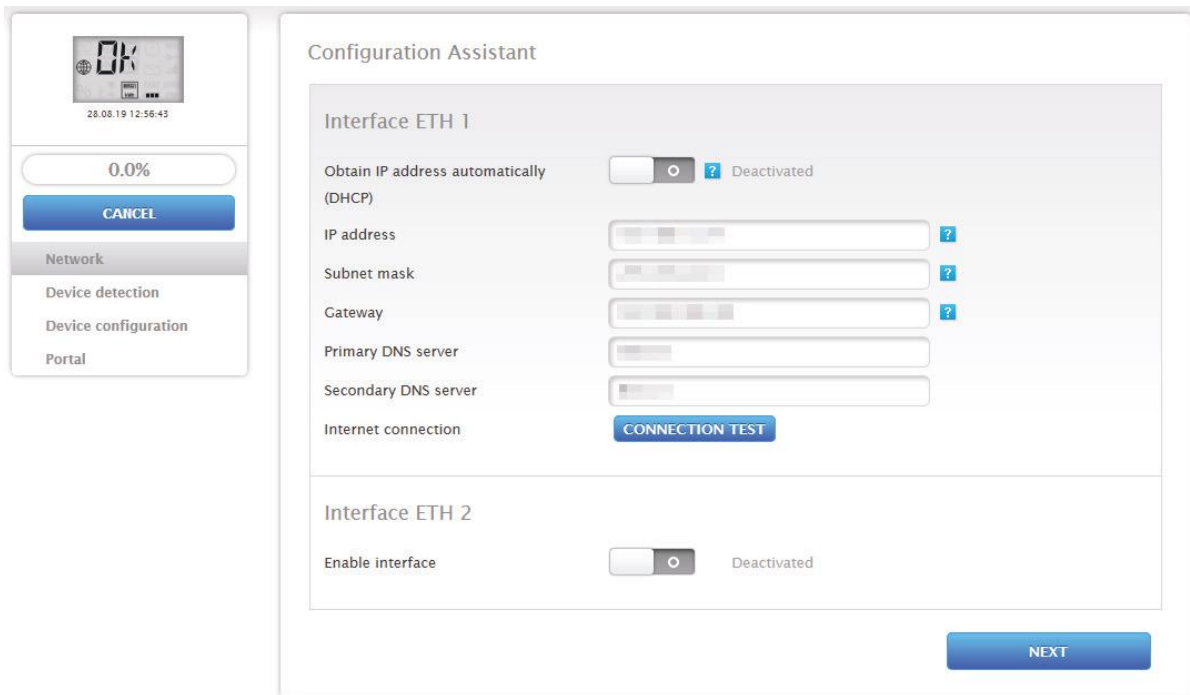

Fig.: Solar-Log™ Ethernet settings from the Solar-Log™ Configuration Wizard

Under some circumstances, it can be that a second network is required and then a second Ethernet interface can be activated. (see the following illustration)

Go to the Main Menu.

The screenshot shows a 'Configuration Assistant' window with three main sections:

- Interface ETH 1:** 'Obtain IP address automatically (DHCP)' is set to 'Deactivated'. Below are input fields for IP address, Subnet mask, Gateway, Primary DNS server, and Secondary DNS server. A 'CONNECTION TEST' button is at the bottom.
- Interface ETH 2:** 'Enable interface' is set to 'Activated'. 'Obtain IP address automatically (DHCP)' is set to 'Deactivated'. Below are input fields for IP address and Subnet mask.
- Functionalities on interfaces:** 'Device connection' and 'ModbusTCP interface' are both checked for 'ETH 1' and unchecked for 'ETH 2'.

A blue information box at the bottom states: 'Unlisted functionalities are either only available on interface ETH 1 (e.g. internet connectivity) or on all interfaces (e.g. local web interface or public JSON interface).' A 'NEXT' button is at the bottom right, and a message 'The changes have not been saved.' is at the bottom left.

Fig.: Example with the second Ethernet interface active

As with Ethernet 1, there are two options for IP address:

Either a dynamic IP assignment with DHCP (Obtain IP address automatically (DHCP) or assigning a static IP address.

The following boxes need to be defined:

The IP address of the Solar-Log™, the subnet mask of the second network and the assignment of the functions for the interface. (Please pay attention to the help texts during the configuration as well as the information text below.)

Then click "save" to apply the settings.

Note



When a second Ethernet interface is required, it is important to note that the IP address of the Solar-Log™ for the second Ethernet interface needs to be "logically" separated network and cannot be the same IP address as defined for the first ethernet interface.

Explanation of the example:

If the IP address of the Solar-Log™ for the first Ethernet interface is 192.168.0.1 and the subnet mask 255.255.255.0, then the IP address for the second Ethernet interface has to be in another network (logically separated), for example 192.168.2.1 with 255.255.255.0 as the subnet mask.

Connection Test

Use the "Connection Test" button to determine if the entries are correct and if a connection can be successfully established. The message indicates if the connection was successful or not. (See the following illustrations)



Fig.: Example of a successful connection test

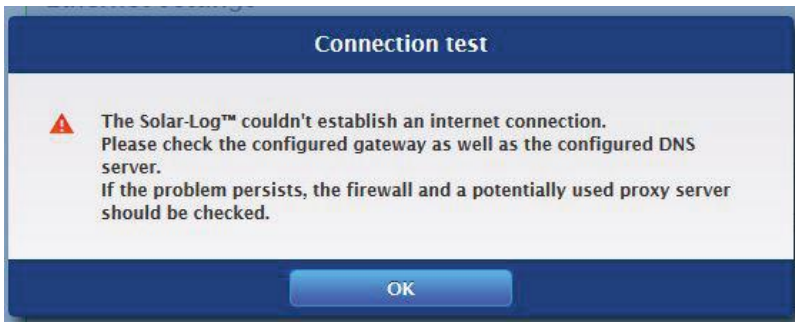

Fig.: Example of an unsuccessful connection test

Note



All entries are saved automatically by clicking on the "Next" button. Clicking on the "Back" button allows to go back and change the settings at any time.

If the test is successful, click on the "Next" button to go to the next section. A dialog window appears. From this window, you can check if a new Solar-Log™ firmware version is available (see image "Displayed Firmware Update Window").

Go to the Main Menu.

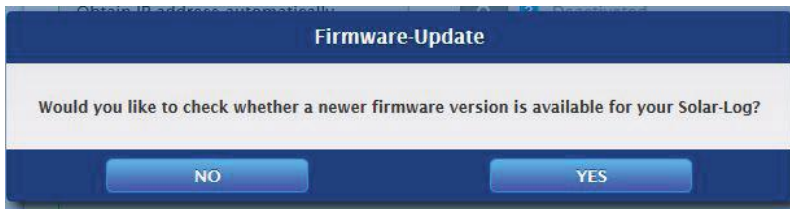

Fig.: Displayed Firmware Update Window

By clicking on "Yes," the configuration wizard checks for a new firmware version and can install it after that. At the end, the interface detection is performed. When not confirmed, the interface assignment appears.

Note



The device detection is to be performed after the components have been connected. Otherwise the corresponding boxes for the components are grayed out.

Interface assignment

The connected components have to be assigned in the interface assignment section.

Procedure:

- Click on the plus symbol.
- Select the device class, manufacturer, type (depending on device) and interface.
- Confirm by clicking on "OK."
- Repeat these steps for assigning the second interface.

When the selection of connected devices is complete, click on the "Start" to start the Device Detection. (See "Device Definition" chapter)

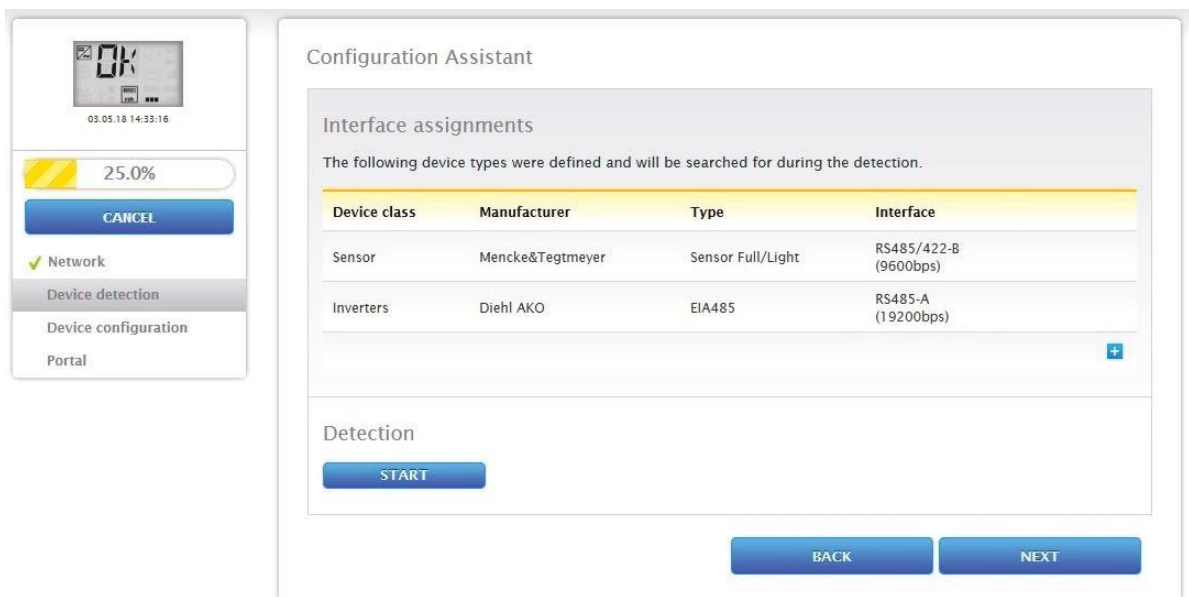

Fig.: Configuration wizard - Example - Interface Assignments

Note



The device detection can be canceled by clicking on the "Skip" button – for example, when there is incorrect interface assignment or number of detected devices.

Note



The Solar-Log™ operates in installation mode for 30 days after the device detection. On day 31, "Yield Data" and "Diagnostic" no longer appear (refer to "Maximum Plant Size"). The following message appears: "Attention - import Plant Size License."

Click on "OK" after a successful detection. Then click on "Next." The device configuration menu appears. In the device configuration, one can, for example, define the generator output, the module fields and the names of the individual components. (Also refer to the chapter "Device Configuration")

Configuration Assistant

Device configuration

Device: 1: WR 1

Model: 13000 TLD

Address / serial number: 0000.000214016

Module field, power & label

Maximum AC Power: 12900 W

Pac Correction Factor: 1000

Module field	Generator Power	Name
Device	14700 Wp	WR 1
MPP Tracker 1	4900 Wp	String 1
MPP Tracker 2	4900 Wp	String 2
MPP Tracker 3	4900 Wp	String 3

BACK NEXT

Fig.: Example – Configuration Wizard – Device Configuration

The "portal" page is loaded by clicking on "next." Here the data transfer to the Solar-Log WEB Enerest™ portal can be activated.

The box "Portal Server" appears once the data transfer to the Solar-Log WEB Enerest™ portal is activated. There are two options for entering the portal server:

- Option when the Solar-Log™ has already been registered on the portal:
If you know the portal server, you can manually enter it. Otherwise, there is the option to automatically enter the portal server by using the "Obtain automatically" function (above the globe symbol).

Go to the Main Menu.

- Option when the Solar-Log™ has not been registered on the portal:
If the Solar-Log™ has not been registered on the portal, the function to obtain portal server automatically can be started with the globe symbol. The "portal server" box is grayed out and the Solar-Log™ goes into a waiting state and remains in this state until it has been registered in the Enerest portal. After that the Solar-Log™ obtains the portal server automatically.

After clicking on "Next," the configuration wizard is finished and a summary is displayed. (See illustration: "Configuration Wizard Summary")

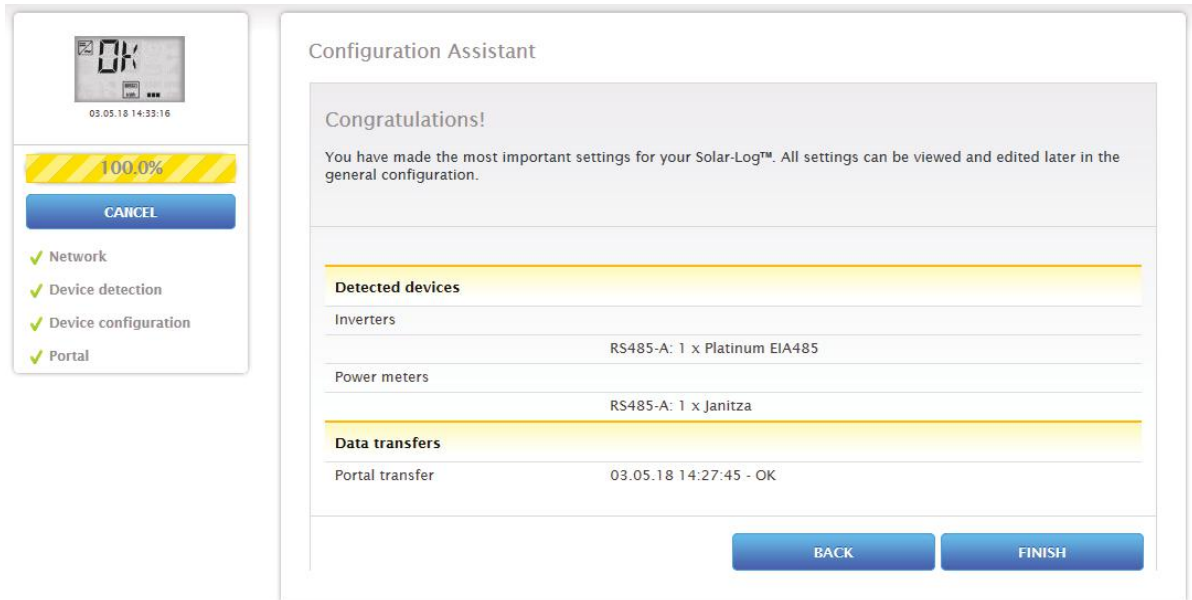

Fig.: Example – Configuration Wizard Summary

Access the menu "Yield Data" under the "Table" tab with the "End" button.

Maximum Plant Size

Model	Plant size
Solar-Log Base 15	15 kW
Solar-Log Base 100	100 kW
Solar-Log Base 2000	2000 kW

Refer to the data sheet on our website ([Solar-Log Base Data Sheet](#))

11.3.1 Manual Configuration of the Solar-Log Base

After the device connection has been established and the Solar-Log™ has been connected to the Internet router, the basic configuration of the Solar-Log Base is done via a web browser. All settings made at the initial startup can be changed later at any time.

Procedure:

- Enter <http://solar-log-wxyz> in the web browser address bar (wxyz stands for the last 4 digits from serial number of the Solar-Log™).
- A selection of display languages is displayed.
- Select the desired [Display Language](#). Click on [Continue](#).
- Define the country and time zone. [Continue](#).
- The Access Protection menu is displayed. Click on [Continue](#) after defining the user password.
- The Configuration Wizard is displayed. Click on [Cancel](#) to perform a manual configuration.
- Select "[Configuration](#)" from the menu in the header bar.
- The following can be manually configured from the [Configuration](#) menu:
 - Network
 - Internet
 - Devices
 - Data
 - System

(For a detailed description of the configuration, refer to the chapter: "[Configuration Menu](#)")

12 Main menu

The main menu on the Solar-Log™ is divided into three sections:

- Configuration
- Diagnostics
- Yield data

In addition, the following sub-menus are displayed in this view:

- Cockpit
- Energy flow
- Table

These are also located on the left side of the of the VLCD Display (see "VLCD Display" section for more details) and in additional sub-menus (depending on connected the devices) and as a selection in the main navigation menu.

12.1 Virtual LCD Display (VLC Display)

The VLC Display is located above the left navigation menu and displays the notifications from the Solar-Log™ in the form of codes and symbols in addition to the date and time. The codes and symbols correspond to those for the LCD display. (See illustration "VLCD Display") The notifications are in real time.



Fig.: VLCD Display

12.2 Meaning of the symbols on the virtual LCD display (VLCD Display)

The following symbols are shown on the Solar-Log™ virtual LCD display:

Meaning of the symbols on the virtual LCD display







Symbol	Meaning
	Inverter
	Internet or Network
	Meter
	Booting progress
	Time
	Input box for fault codes

Fig.: Virtual LCD Display - Meaning of the symbols

12.3 Fault messages

Fault messages from the connected devices

If a device cannot be contacted by the Solar-Log™ (offline), the respective symbol blinks. OK is not displayed.

Fault codes for connected devices

The respective component symbol blinks and an "E" is in the first position of the text box.

A blinking code is displayed in the second position of the text box. The fault code sequence always starts with "R."

That is followed by a blank and then the code numbers are displayed in the sequence.



Fig.: Example for a blinking code sequence for Internet - Fault 4

12.4 Normal operation

The symbol for the connected components is continuously illuminated.

When there are no problems or faults, OK is displayed on the virtual LCD display.

12.5 Configuration

The [Configuration](#) menu is divided into the following sub-sections:

- Network
- Internet
- Devices
- Plant
- Smart Energy
- Feed-In Management
- Direct Marketing
- Data
- System

The following sub-sections of the menu will be explained separately in the following chapters.

12.5.1 Network

The network settings can be accessed from the [Configuration | Network](#) menu.

The menu is divided into the following sub-sections:

- Ethernet
- Proxy

Note



Requests and control commands are sent to the inverters, battery systems and intelligent appliances via the network interface. For this reason, the network should always be available (24/7).

12.5.1.1 Ethernet

Configuration / Network / Ethernet

ETHERNET PROXY

Interface ETH 1

Obtain IP address automatically (DHCP) Deactivated

IP address

Subnet mask

Gateway

Primary DNS server

Secondary DNS server

Internet connection

Interface ETH 2

Enable interface Deactivated

Fig.: Ethernet settings for the first Ethernet interface

The network settings for the Solar-Log™ can be defined in the Ethernet menu.

12.5.1.2 Interface ETH 1

This chapter describes the setting options for the first Ethernet interface.

Obtain IP address automatically (DHCP)

Here the following options are available:

- Activate Obtain IP address automatically
- Deactivate Obtain IP address automatically.

Since the Solar-Log™ has DHCP (obtain IP address automatically) active by default, check whether DHCP the server activated on the router. If the DHCP server is disabled in the router, the network settings must be configured manually. If necessary, please consult a network specialist who can assign a suitable network address in regard to IP address, Subnet mask and Gateway, for example.

If the Solar-Log™ is to have a **fixed IP address**, the **Obtain IP address automatically (DHCP)** switch needs to be **deactivated**.

The following fields need to be adjusted according the network's configurations.

IP address

The address needs to be entered manually in order to allow remote PC access, when using a direct PC connection or a router without DHCP service.

Subnet mask

The subnet mask address is to set to 255.255.255.0 by default. **Gateway**

The gateway is typically the IP address of the router to which Solar-Log™ is connected. That IP address is to be entered here.

Primary DNS server

In some networks, the DNS server is a separate address for resolving Internet addresses. In this case, the IP address of the DNS server is entered here.

Secondary DNS server

Enter a secondary DNS server here if it is required for the network. The secondary DNS server is used to resolve Internet address names when the primary DNS server is not available.

Once finished, click on **Save**.

Connection Test

Use the "Connection Test" button to determine if the entries are correct and if a connection can be successfully established. The message indicates if the connection was successful or not. (See the following illustrations)

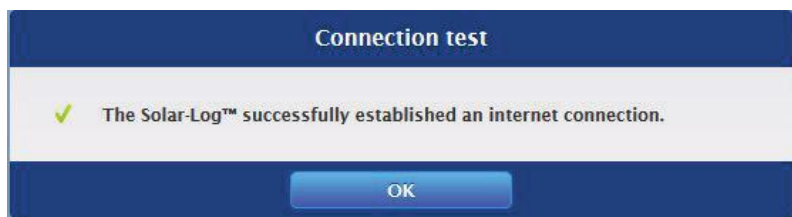

Fig.: Example of a successful connection test



Fig.: Example of an unsuccessful connection test

12.5.1.3 Interface ETH 2

Here there is the option to activate a second Ethernet interface in order to separate the IT network from the PV plant.

Note



The Ethernet interface does not have any switch functions.

Fig.: Active second Ethernet interface

As with Ethernet 1, there are two options for IP address:

Either a dynamic IP assignment with DHCP (Obtain IP address automatically (DHCP)) or assigning a static IP address.

The following boxes need to be defined:

The IP address of the Solar-Log™, the subnet mask of the second network and the assignment of the functions for the interface. (Please pay attention to the help texts during the configuration as well as the information text below.)

Then click "save" to apply the settings.

Note



When a second Ethernet interface is required, it is important to note that the IP address of the Solar-Log™ for the second Ethernet interface needs to be “logically” separated network and cannot be the same IP address as defined for the first ethernet interface.

Explanation of the example:

If the IP address of the Solar-Log™ for the first Ethernet interface is 192.168.0.1 and the subnet mask 255.255.255.0, then the IP address for the second Ethernet interface has to be in another network (logically separated), for example 192.168.2.1 with 255.255.255.0 as the subnet mask.

12.5.2 Proxy

Fig.: Proxy settings

The proxy settings need to be configured in the Solar-Log™ to enable Internet communication via the proxy server. Proxy servers are typically used in the networks of organizations and companies.

The proxy function is not enabled by default. Configure the proxy in the [Configuration | Network | Proxy](#) menu.

Procedure

- Select **Connect** for the type of the proxy server.
- Enter proxy server, port, user name and password.
- **SAVE** the settings.

12.6 Internet

Select the Internet from the [Configuration | Internet](#) menu.

The following tabs are displayed:

- Portal
- Export

12.6.1 Portal

The following functions are available in this tab:

- Activate/deactivate transfers.
- Activated:
 - Status
 - Test

Note



Please download the Solar-Log WEB Enerest™ Home User Manual from our website to efficiently use and configure the Solar-Log WEB Enerest™ Home. Located here: <https://www.solar-log.com/en/support/downloads/>

Solar-Log WEB Enerest™ section

The following selection options are available in this section:

- Activate/deactivate transfers.
- Portal server. There are two options for entering the portal server:
 - Option when the Solar-Log™ has already been registered on the portal:
If you know the portal server, you can manually enter it. Otherwise, there is the option to automatically enter the portal server by using the "Obtain automatically" function (above the globe symbol).
 - Option when the Solar-Log™ has not been registered on the portal:
If the Solar-Log™ has not been registered on the portal, the function to obtain portal server automatically can be started with the globe symbol. The "portal server" box is grayed out and the Solar-Log™ goes into a waiting state and remains in this state until it has been registered in the Enerest portal. After that the Solar-Log™ obtains the portal server automatically.
- Transfer interval.
- **SAVE** the settings.

Status section

The following fields are displayed in the Status section:

- **Date** (Last Export).
- **Error** (Last Export).

Test section

A connection test can be performed in the Test section. A separate pop-up window is displayed with the progress of test. The connection test also indicates if the test was successful or not. If it was not successful, it displays the error. After the tests are finished, possible causes for the connection problems are listed. (See the following example illustration).

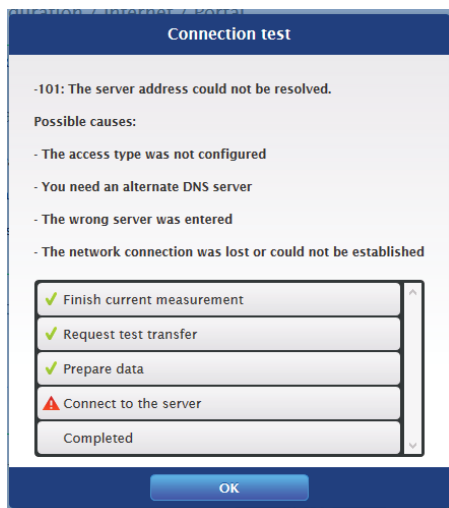

Fig.: Example - Transfer Test with an Error Image

After confirming with OK, an additional field with the status of the test is displayed in the Test section. Question marks indicate that the test was unsuccessful and possible causes are listed.

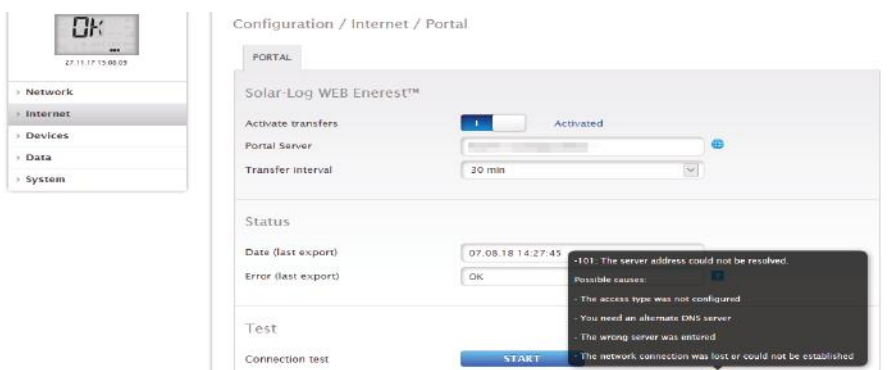

Fig.: Example - Connection Test with an Error

12.6.2 Export

The automatic data export allows the yield data to be periodically transferred to the server. Various export intervals are available.

FTPS Export Settings section

Procedure

- [Activate](#) Export switch.
- Enter the name of the server name in the [FTPS server](#) box.
- Enter the [FTPS user name](#) and [password](#) from the FTPS server access data.
- A directory only has to be entered here if the Solar-Log™ homepage is not to be located directly in the main directory of your homepage. Otherwise, this box can be left empty.
- The [Export Interval](#) determines how often the Solar-Log™ transmits the data to the server.

SSL certificate

Under SSL certificate, an SSL certificate can be uploaded for a more secure connection. Please refer to the help text for more information about certificates.

Status & Test section

Click on the “Start” button to check the settings for errors.

- [SAVE](#) the settings.

Status & Test external server section

In this section, the export settings can be tested The information from the last export is displayed.

12.7 Configuring connected devices

From the menu [Configuration | Devices](#), the PV plant components connected to the Solar-Log™ can be

- defined
- detected
- and configured.

We recommend the following procedures for new installations:

- First define the interface to be used for the connected devices
- Device detection.
- Device configuration.

12.7.1 Device definition

The [Configuration | Devices | Definition](#) menu is divided into the following sub-sections:

- Interfaces
- Large External Display
- SCB (license required)

Configuring the device interface section

The interface for the connected devices needs to be defined from the [Configuration | Devices | Definition | Interfaces](#) menu before performing a device detection.

Procedure:

- Go to the plus symbol under "Interface assignments".

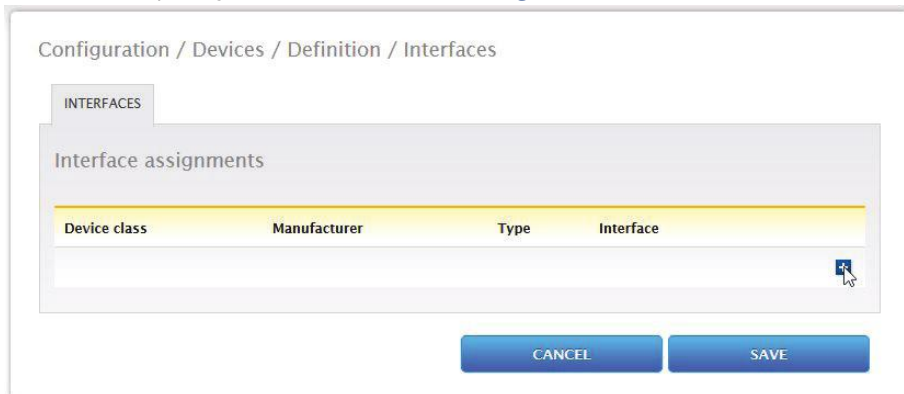

Fig.: Interface definition via the plus symbol

The following window appears:

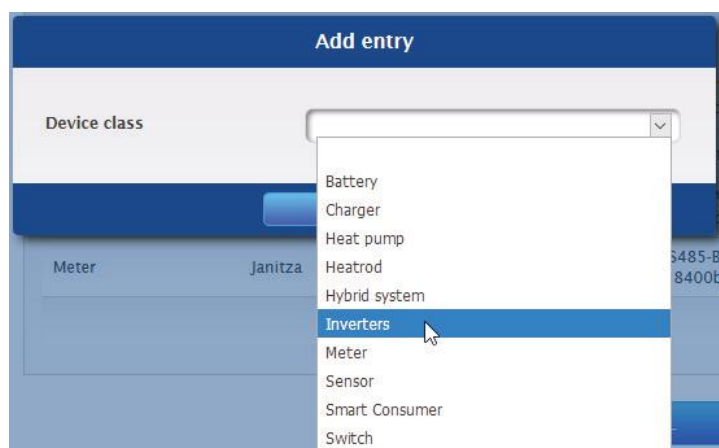

Fig.: Adding components

The connected components are selected in the [Device class](#) box. The following device classes can be defined:

- Battery
- Heating Rod
- Hybrid System
- Smart Appliances
- Charging Station
- Switch
- Sensor
- Inverter
- Heat pump
- Meter

Depending on the device class and/or the selected [Manufacturer](#), additional boxes visible:

[Type](#), [Interface](#) and [Baud rate](#).

Furthermore, an existing [Wireless Package](#) can be activated here and the expected reply time for a device connected to this bus is increased.

Note



Caution: Using different manufacturers on the same serial bus may cause communication problems.

Only the network interface (Ethernet) can have multiple assignments according to our component database at <https://www.solar-log.com/en/support/>.

If the device class is correct, confirm the selection with **OK**. Define additional connected device classes as described.

If all of the connected components have been selected and confirmed with **OK**, an overview is displayed in the interface assignments. (See illustration: "Overview of the selected components")

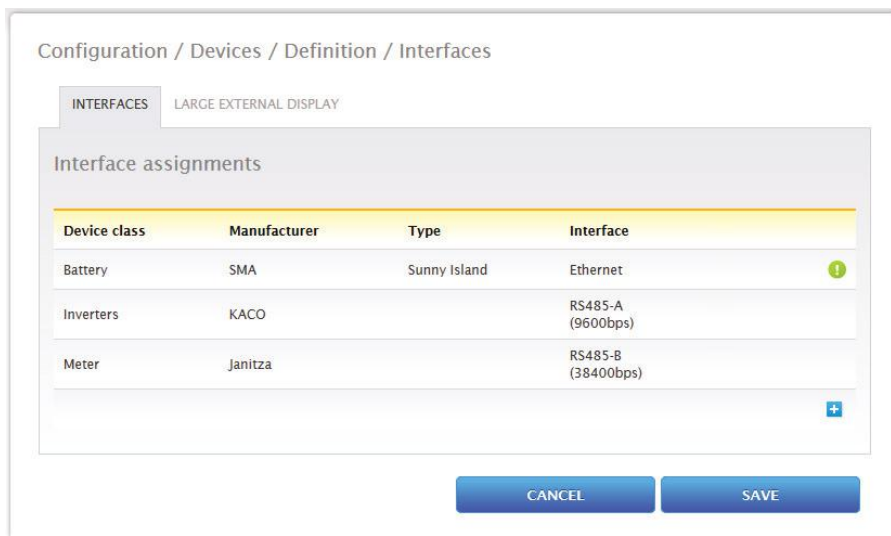



Fig.: Overview of the selected components

From the overview, there is the option to check whether the settings are correct and, if need be, adjust or delete them with the  and  symbols. (The symbols are only displayed by moving the mouse over the components.) Additionally, the following is displayed in the overview of the device interfaces:

- Device class

The selected devices can be seen here. In the example:

- Sensors
- Inverter
- Meter

- Manufacturer

The manufacturer is displayed in this column. In the example:

- Mencke&Tegtmeyer
- Diehl AKO
- Janitza
- Type

The defined types are listed in this column. In the example:

- Sensor Full/Light
- EIA485

- Interface

Interface indicates which interface and baud rate the devices are using.

Click on **SAVE** if all of the definitions are correct.

Note



The number behind the interface (e.g. x1) indicates the number of switching devices for this device type.

Note



If a driver license needs to be purchased, this indicated with the information symbol and information text under the Interface Assignment Definition (Device Detection) when adding components.

12.7.2 Device Detection

During the Device Detection, all of the components that have been predefined in the Configuration | Devices | Definition are searched for and detected. The internal data structure of the Solar-Log™ is prepared for the detected components.

Procedure:

- Select Configuration | Devices | Detection from the menu.
- The components which were predefined in the Device Definition menu are displayed in the overview.



Fig.: Device detection - not started yet

- **START** Device Detection.
- The Device Detection goes from the top listed interface to the bottom listed interface when searching for devices.

The progress of the device detection is displayed in a window that automatically appears.

- The detected devices are displayed with the number of devices per bus.
- If all of the devices on a bus have been detected, the rest of the search can be skipped. The search is then continued on the next bus.
- The Device Detection is completed once all of the buses have been checked.
Status message: New device detected, the data is being reformatted.
- The Solar-Log™ reboots itself.

Note



Once the detection has been successfully completed, individual device classes can be removed with the  symbol without having to initialize the complete device configuration.

12.7.3 Configuring devices

After the Device Detection has been successfully completed, the detected devices have to be defined in the [Configuration | Devices | Configuration](#) menu.

Depending on the device, different settings might be needed for the configuration.

Procedure:

- Select the device that needs to be configured in the Device Configuration section.
- Depending on the device type, different configuration boxes appear.
- The entries for the sections below – Module Fields, Power Output and Descriptions – are mostly identical.

Configuring inverters

The following values have to be configured for inverters:

- Maximum AC Power.
- Pac Correction Factor.
- Module field.
- Generator Power and MPP tracker output (according to the string plan)
- Labels or names of the inverters and/or MPP trackers.

Procedure:

- **Select Device.**
- Enter the
- **Maximum AC power:**
from the inverter's data specification in the section: Module Field, Power and Name.
- Enter the **Pac Correction Factor** (for more information, refer to the section [Generation Information on PAC Correction Factor](#)).
- Define **Module Field:**
Inverters can be assigned to be different module fields. See Chapter: „12.7.11 Modulfelder“.
- **Generator Power:**
The connected power of the individual inverters in Wp. The total power can be calculated using the formula: Module power * Number of modules. The output does not have to be entered. It is calculated from the total generator power values that have been entered for the MPP Tracker.
- The **generator power** for every **tracker** needs to be entered if the inverter has several MPP trackers.
- A distinct name can be assigned to every generator/MPP tracker in the **Label** box.
- **SAVE** the settings.

12.7.4 Generation Information on PAC Correction Factor

At photovoltaic plants, several measuring points and power generators (inverters) are combined with one another. The Solar-Log™ evaluates this data and partially looks for any correlations.

For example, if the total amount of energy produced based on what the inverters display is compared with the values from calibrated power meters, deviations of up to 8 % can arise.

In practice, meters and inverters both can display too much or too little kWh.

To correct these inaccuracies in the medium term, the Solar-Log™ firmware uses a PAC correction factor.

Calculating the PAC correction factor

All yield data are always stored internally without any correction factor. This factor is applied only when the data are displayed. The factor can therefore be adjusted at any time.

The formula for calculating the correction factor is as follows:

$(\text{Yield power meter} / \text{yield inverter}) * 1000$

If the inverter does not have a display, it is advisable to use the values which are recorded by the Solar-Log™ from a period over a week.

That is why it is recommended to leave the default PAC correction factor at 1000 initially.

The correction factor can be adjusted yearly after receiving the statement from the utility company.

Example calculation:

Inverter 1	Inverter 2	Calibrated power meter
Total energy	Total energy	Total energy
259.12 kWh	305.22 kWh	550.55 kWh
Total = 564.34 kWh		Deviation= 13.79 kWh

By comparing the values, you see that the inverters are more likely to display too much output.

Pac Correction Factor

Calibrated power meter total energy	Inverter total energy
550.5 kWh	564.34 kWh
Calculated PAC correction factor in the example.	
$(550.55 \text{ kWh} / 564.34 \text{ kWh}) * 1000 = 975.66$	
Rounded PAC correction factor = 976	

12.7.5 Configuring power meters

An operating mode needs to be assigned to power meters to configure them.

Possible operating modes for power meters:

- Generator (records the individual producers, e.g. PV inverter or CHP).
- Meter for the entire plant (records the complete PV plant output).
- Consumption meter (records the complete consumption).
- Utility Meter (U).
- Utility Meter (U+I).
- Utility Meter (U+I) + Consumption Meter (bi-directional).
- Sub-consumption meter (records the consumption from individual appliances).
- Consumption Meter (Bi-directional meter).
- Battery meter (Bi-directional meter).
- Deactivated.

Depending on the selected operating mode and/or meter type, additional selection boxes appear, such as [Energy type](#) and/or [Impulse rate](#).

Note



Several consumption meters can be defined for every plant. Their measurements are added to the total consumption.

Note



A sub-consumption meter is a consumption meter whose consumption has already been recorded by another meter. It is used to visualize the consumption from a particular appliance or group.

Procedure

- Select Device.
- Select the desired operating mode from the Meter configuration section.
- If needed, assign a plant group to this meter.
- SAVE the settings.

12.7.6 Configuring sensors

Under sensors, the configuration only comprises of activating other sensors.

Procedure:

- Use the **Ambient Temperature** and/or **Wind** button to **activate** the sensors.
- If needed, make assignments to the module field.
- **SAVE** the settings.

12.7.7 Configure the battery

The following configurations can be made here for the connected battery.

- **Battery size:**
Enter the battery size in Wh in this box.
- **The consumption meter records the battery charge.**
This box enables recording the battery charges from the consumption meter.
- **Delay battery charge:**
With this function, charging the battery can be delayed based on the weather forecast so that the battery is charged an expected power reduction occurs to prevent energy from being wasted.

Note



The following components always have to be used for battery monitoring to work:

- ▶ Inverter
- ▶ Battery
- ▶ Consumption meter

Note



Refer to the chapter 17.2 "[Battery Diagnostic](#)" for further details on diagnostic.

Battery charging time shift function (only with Varta battery systems):

When the plant has to fulfill a percentage based reduction (x% - EEG/subvention), the Solar-Log™ can shift the charging time of the battery to a period of peak power production, thus eliminating the need to reduce the total output. The Solar-Log™ includes the weather forecast data and plant consumption data into the calculation for battery charging management. This means that Solar-Log™ saves the typical consumption data from the past and checks this data to ensure that the battery is charged completely. The charging times are adjusted accordingly as needed.

12.7.8 Configuring EGO Smart Heaters

The EGO smart heater can be selected and configured accordingly from the Device Configuration section in the [Configuration | Device | Configuration](#) menu.

Procedure:

- Select the Smart Heater from the drop-down menu under devices.
- Enter the maximum storage temperature [C°].
The maximum storage temperature can range from 40°C to 80°C . When 0 is entered, the settings from the Smart Heater for its potentiometer are used.
- Configure and active the minimal temperature as needed. Once the temperature falls below this value, the water is automatically heated to 7° C with the configured output.
- Select the operating mode from the meter configuration menu. The EGO Smart Heater can be configured as a consumption meter or a sub-consumer.
- Enter the description under Module Fields, Power Output and Descriptions.
- **SAVE** the settings.

Information on the maximum storage temperature for the EGO Smart Heater

By default, the maximum boiler temperature is adjusted with the rotary switch on the EGO Smart Heater. To be able to control the temperature from the Solar-Log™, the rotary switch on the EGO Smart Heater has to be set higher than the value from the Solar-Log™ because the settings from the rotary switch determine the maximum temperature for external control

Example:

If the rotary switch is set to 40°C and the Solar-Log™ to 60°C, the settings from the Solar-Log™ will be ignored and the value from the rotary switch will be applied. The range for the rotary switch has to be set higher so that the Solar-Log™ can assume control. In the example to 60°C.

For this reason, we recommend setting the rotary switch to a maximum of 80°C – or the maximum boiler temperature that is not to be exceeded – when the Solar-Log™ is to control the temperature externally. The Solar-Log™ can control the temperature when it is in the range below the set maximum value.

Note



The EGO Smart heater is an intelligent appliance. The available reported surplus is reported to the intelligent electrical appliances and can be consumed by them.
The simultaneous connection of several intelligent electrical appliances is supported.

12.7.9 Configuring IDM Heat Pumps

The IDM heat pump can be selected and configured accordingly from the Device Configuration section in the [Configuration | Device | Configuration](#) menu.

Procedure:

- Select the IDM heat pumps from the drop-down menu under devices.
- Select the operating mode from the meter configuration menu.
- Configure the device.
- **SAVE** the settings.

The following configuration options are available for the operating mode.

Operating modes:

- Consumption meter mode:
 - Group selection for PM control with self-consumption.
 - Maximum AC power
 - Name
- Sub-consumption meter mode:
 - Maximum AC power
 - Name

Note



The IDM heat pump is an intelligent appliance. The available reported surplus is reported to the intelligent electrical appliances and can be consumed by them.

The simultaneous connection of several intelligent electrical appliances is supported.

12.7.10 Configuring the Keba Power Charging Stations

The Keba power charging station can be selected and configured accordingly from the Device Configuration section in the [Configuration | Device | Configuration](#) menu.

Procedure:

- Select the Keba power charging station from the drop-down menu under devices.
- The model, address and serial number are automatically applied and cannot be modified.
- The following configurations can be made under Charge control:
 - There are different selection options for the [current limiting function](#) in this section:
 - **No control** – The Solar-Log™ only records the charging data without any control of the charging process.
 - **Surplus** - The electric car only charges when there is enough PV power available. The Solar-Log™ takes the defined minimum charge level into consideration. In this case, the release of power for the charging station corresponds to the amount of surplus.
 - **Surplus / Minimum charge level** - This ensures that the car always reaches its minimum charge level even when no PV power is available. When there is an energy surplus, the Solar-Log™ informs the charging station.
 - **Always charge** - The Solar-Log™ allows the charging station to consume power without any restrictions, regardless of the production or surplus levels.
 - **Minimum charging power [mA]** - The defined minimum charging power value is taken into account.
 - **Maximum charging power [mA]** - The defined maximum charging power value is taken into account.
 - **Switch-off delay [Min.] (only when used with the current limiting "Surplus Charging")** - The switch-off delay option defines when the charging process should be stopped after the previous surplus is no longer available. This options prevents the charging process from being interrupted by short-term fluctuations in the amount of available surplus. The time factor can be defined from 1 to 60.
 - **Forced charging via wall switch (X1):**
 - Activated
 - Deactivated
- Select the operating mode from the meter configuration menu. The Keba power charging station can be configured as a consumption meter or a sub-consumer.
- Enter the description under Module Fields, Power Output and Descriptions.
- **SAVE** the settings.

Note about forced charging via wall switch (X1)

If a wall switch is installed and connected to X1 on the charging station, the charging station is allowed via the Solar-Log™ to consume the defined maximum power levels without any restrictions, regardless of the production or surplus levels.

If a wall switch has not been installed, the Solar-Log™ configuration defined for the current limiting function can be set to "always charge." This also allows for charging according to the defined maximum power level.

12.7.11 Module Fields, Power Output and Descriptions

Depending on the device type (power meter, inverter, etc.), different settings can be adjusted from the **Module Fields, Power Output and Descriptions** menu. See the following chapters:

- Configuring inverters,
- Configuring power meters and
- Configuring sensors.

In this section, for example, the device name can be changed and the nominal power (maximum AC output) of the individual devices can be defined.

The nominal power (maximum AC output) if the average consumption or the average energy production of a device and is used, for example, for the profile controls (Smart Energy).

Note



The most exact that the configured nominal power corresponds to the actual consumption, the more accurately the control of consumption via Smart Energy is.

Module Fields

Each connected MPP tracker is assigned to a module field. Module fields are subdivided according to the type of the solar module, angles of inclination and alignment. If all modules within a system are of the same type and have the same alignment, only one module field, e.g. "1", is defined. MPP trackers that are not used must be switched off (switched to "0").

Additional module fields need to be defined for modules with different alignments and module types.

Ideally, each field should be made up of at least two individual MPP trackers, which monitor each other. The module fields are used for performance monitoring. In contrast, plant groups (Chapter "Plant groups" auf Seite 85) are used for the commercial calculations.

Example module fields:

A plant with 23.6 kWp is divided into:

3 x SMA SB5000TL and

2 x SMA SB2500.

18 kWp is located on a barn roof with 30° inclination, 20° South-East deviation, and 5 kWp on an adjoining garage roof, 32° inclination, 0° South deviation.

This results in two module fields according to the following table:

Division of the module fields

Location	Inverter	MPP Tracker output	Module field
Barn	1. SB5000TL	2000	1
Barn	1. SB5000TL	2000	1
Barn	1. SB5000TL	2200	1
Barn	2. SB5000TL	2000	1
Barn	2. SB5000TL	2000	1
Barn	2. SB5000TL	2200	1
Barn	3. SB5000TL	2000	1
Barn	3. SB5000TL	2000	1
Barn	3. SB5000TL	2200	1
Garage	1. SB2500	2500	2
Garage	2. SB2500	2500	2

Changing the device order section

The sequential order of the inverters and other devices is determined during inverter detection. They are normally sorted by their serial number or communications address.

The order can be changed through drag and drop from the [Configuration | Devices | Configuration | Order](#) menu.

12.8 Configuring Plant Data

There are settings for the following sections in the **Plant** menu:

- General
- Plant groups
- Graphic
- Forecast

12.8.1 General

Environmental performance

The CO₂ factor per kWh can be setup for each electricity tariff. The value is displayed in g/kWh. Contact your power company for the exact number for this value. The default setting for this value is 700g/kWh.

12.8.2 Plant groups

Since the Solar-Log™ can manage up to 100 inverters at the same time, it is helpful to divide these inverters into groups. To provide a clearer overview, these groups are then shown in all selection dialog boxes. The data from each plant group can be presented on its own large external display. Each plant group can also be combined with its own consumption meter.

A name, a specific tariff payment and/or a yearly target value can be assigned to each plant group, Plant groups are therefore also suitable for managing system expansions.

Example: If a plant initially has 5 inverters and 30 kWp and is extended at a later date with 3 more inverters and 20 kWp, this addition can be conveniently managed as a separate group with one Solar-Log™.

Individual inverters can then be selected from the group concerned. Plant groups are defined starting with 15 inverters. A maximum of 10 plant groups can be defined.

Note



When using several plant groups, only one plant group can be used with a tariff mode with self-consumption refund or self-consumption.

Note



The function "Distribute automatically" sorts only unassigned devices into groups.

Procedure:

- Select [Configuration | Plant | Plant groups](#) from the menu.
- To use [Plant buttons](#), the button needs to be [activated](#).
- Under [Name](#), a plant group can be uniquely [labeled](#).
- The devices recognized during the Device Detection are now allocated into the device groups.
- Click on  to [display](#) a [list](#) of all of the devices.
- Place a [check](#) in the box next to the devices that belong to this plant group and select [Apply](#).
- For the next steps, additional plant groups and their devices can be defined in the same way.
- [SAVE](#) the settings.

12.8.3 Graphic

The scale of the graphic for individual devices can be adjusted in the graphic menu. Nothing usually has to be changed here, as Solar-Log™ automatically calculates the values for the generator power input. The values can be adapted to your own data.

For each period (day, month, year, total) the maximum value represented in kW can be entered (except Day, which is a value in W).

The graph shows these values on the Y-axis.

Changes become effective when a new graph is displayed or after updating a displayed graph.

The "[Recalculate](#)" function resets the values in the Solar-Log™ and automatically recalculates a new graphic scaling (based on an average plant).

This function can be activated continuously with the switch [Graphic Auto scaling](#) (deactivated by default). The auto scaling option always scales the graphics up as much as possible in the [yield data](#) section. Auto scaling can be disabled for individual graphics.

This function can be activated permanently with the switch [Consumption Line Graphic](#) (deactivated by default). The consumption line graphic can be disabled for individual graphics.

12.8.4 Defining the PV plant's forecast data

By setting forecast values for the yield data, you can check on the graph whether the plant is reaching the desired annual yield or not.

To do this, a percentage rate is allocated to each month. This is deduced from the yield statistics over the previous years.

Solar-Log™ always calculates the target value cumulatively, per day. This means that, at the beginning of the month, it is not the total monthly target that is set, but the target for days already passed, plus that of the current day.

In the forecast, Solar-Log™ also takes account of the yields in all previous years, and in this way can allow for local weather events (in most cases, snow in December). The yearly forecast is therefore usually fairly accurate by September.

Yearly target section

Enter the yearly target value from the installer's plant project planning. The unit of this value is kWh/kWp. Fundamentally, this value depends on the overall irradiation at the plant's location and local factors such as the plant's alignment and shadowing.

In Central Europe, this value is roughly in the range from 800 to 1000 kWh/kWp.

If plant groups are used, it is possible to define a [separate yearly target for each for each plant group](#).

Monthly shares & course of sun section

In this section, the settings for the following can be configured for each month:

- Percentage of the yearly target,
- Sunrise and
- Sunset

Please note that the sum of all of the monthly percentages of the yearly has to always add up to 100%.

12.9 Smart Energy

12.9.1 Defining Smart Energy Switching

The switches that are to be used for the Smart Energy function - switching on appliances in certain consumption or production scenarios - have to be defined and configured (see Chapter "Configuring the device interface").

These switches, as described below, can be configured under the device class definition.

Up to 10 switches are available. They can be assigned to either the same manufacturer/model or to different combinations of manufacturers/models.

Procedure:

- Go to the [Configuration | Devices | Definition](#) menu. Go to Interface assignments on  and select Switch for the device class.

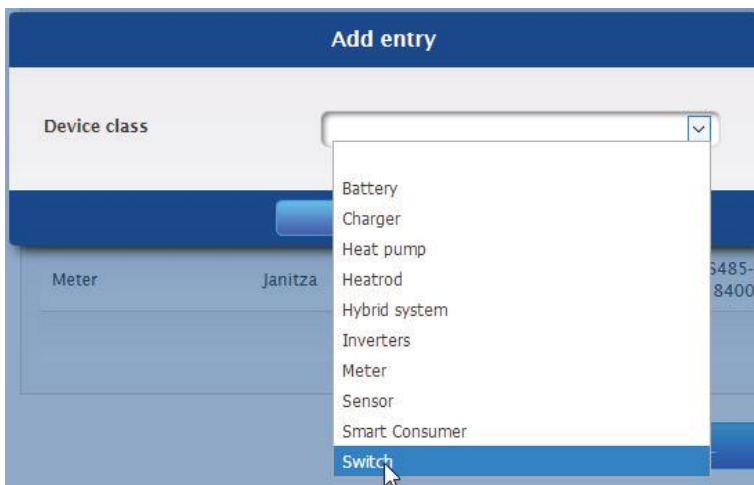

Fig.: Selecting switch for Smart Energy

- The **Manufacturer** box is displayed. The following selection manufacturers are available:
 - AllNet
 - Belkin
 - Gude
 - Solar-Log
- After that, the **Type** has to be defined. Depending on the selected manufacturer, all of the supported models can be selected here.
 - Allnet:
 - 3000RF
 - 3073
 - 3075/3076
 - 3075/3076V2
 - 3075V3
 - Belkin:
 - WeMo Insight
 - WeMo Socket

- Gude:
 - 1002
 - 1100/1001
 - 2104
 - 2110
 - 2301
- Solar-Log:
 - Smart Relay Box
 - Smart Relay Station 1x 3.5kW
 - Smart Relay Station 3x 3.5kW

After that, the number of devices still has to be defined; up to 10 devices are available in total. The Smart Relay Box is the only exception here, instead of the device number box, the interface has to be selected.

- If the definition is complete, confirm by selecting **OK**.
- Define additional switches in the same way.
- Start the detection after defining the interfaces (see Chapter "Device Detection").
- Configure the switches after the detection (See Chapter "Configuring Switches").

12.9.2 Configuring the Switches

Switches are configured in the [Configuration | Devices | Configuration | Configuration](#) menu. Device and meters are to be configured in this menu.

The actual maximum power input is defined in the nominal power (W) under Device in the [Module field, power & label](#) menu. Depending on which switch is used, the correct value is normally already entered here. A unique name can be entered for each device in the label box.

If the switch is to be used for Smart Energy management, the connected output (W) has to be additionally defined for each switch contact. This value in this box serves as the basis to calculate the surplus regulation. This value is used for the contacts that report the current output if the connection to the switch is temporarily interrupted.

Note



The number of contacts depends on the device connected. If the switch does not support output measurements, the device nominal power (W) box is omitted.

Note



This detection differs from the inverter detection in that it does not proceed according to the principle of the search, but a device is set up for every defined switch.

After they have been detected and configured, the switches are available in the [Hardware](#) section under [Configuration | Smart Energy | Switch groups](#) and can be assigned to switch groups.

12.9.3 Smart Energy Switching Groups

There are two tabs under [Configuration | Smart Energy](#):

- Switching groups
- Surplus management

The [Switching groups](#) menu is divided into the following sub-sections:

- Hardware:
All of the detected switches are displayed in this section.
- Switching groups:
The switch contacts for the switching groups can be added in this section and new switching groups can be created and configured. Switching contacts in the switching groups are activated by the Solar-Log™. Unassigned contacts are only recorded – as long as the values can be recorded (depends on the hardware). Up to 10 groups are available. Up to eight contacts can be assigned to each group.

Creating switching groups

There are two ways to create a switching group:

[Version 1:](#)

- Left-click on the "Create switch contact here via Drag & Drop" box.

[Version 2:](#)

- Drag a defined switch from the hardware section to the "Create switch contact here via Drag & Drop" box.

The next steps are identical for both methods.

- A new window with settings appears. Here, the switching group can be given a name and assigned the operating mode "consumer" or "generator."
- Save the settings by clicking on "Continue."
- The switch group is now visible.

(See illustration: "Creating switching groups")

Click on the [Demo](#) box to start the corresponding help for the procedures. (The Demo box is only visible once a switch has already been created.)

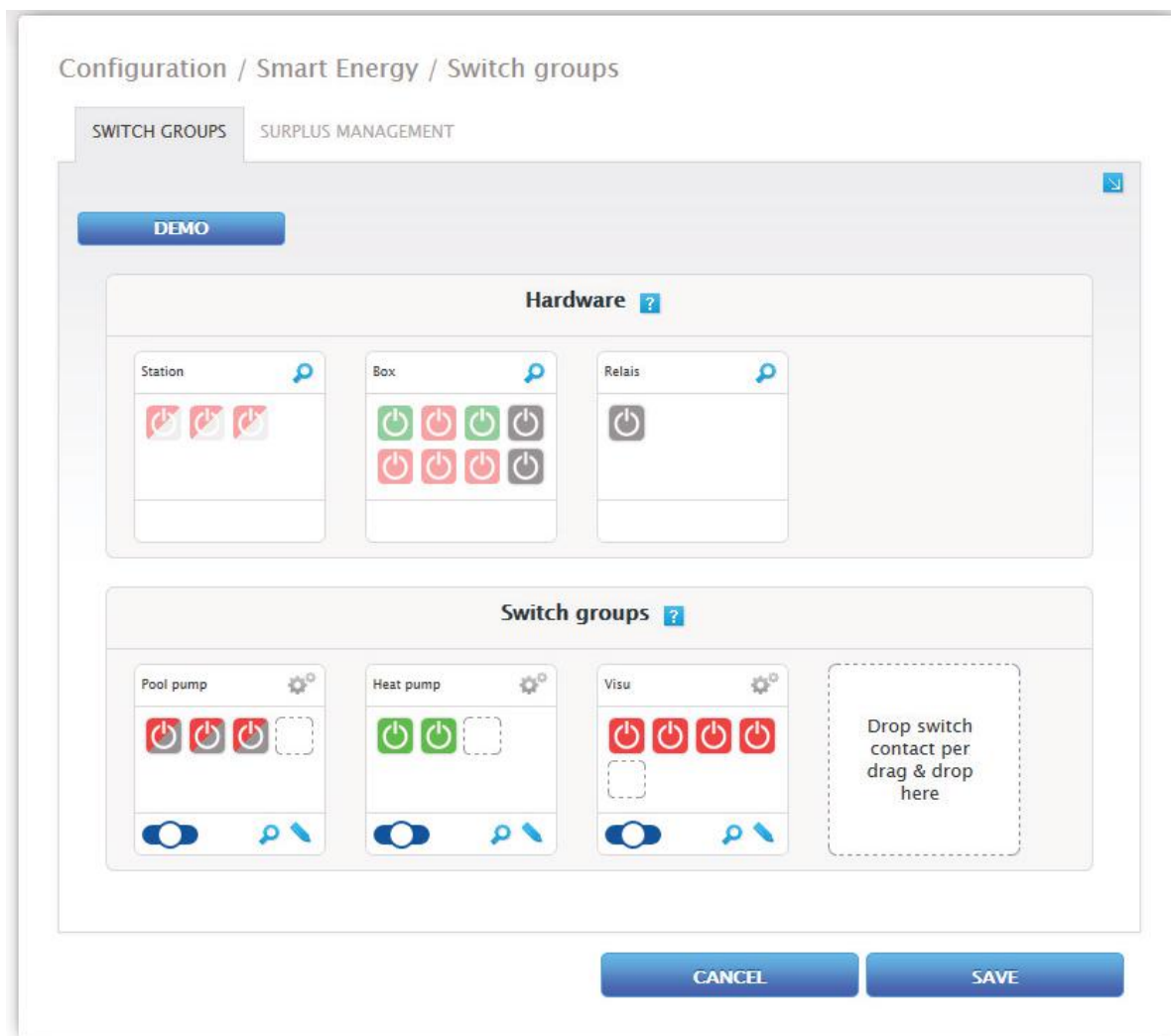



Fig.: Example - Creating switching groups









Note



Click on this symbol  to display all of the hardware data that can be accessed and recorded by the Solar-Log™ and to display the target state.

Switch states / Color Definition

The switching state of each contact is displayed with the following symbols:

Symbol	Explanation Text	Notes
	Target state: On Actual state: On	If the hardware does not support the current state being read, this symbol is also used to clearly identify a fault case.
	Everything OK	
	Target state: Off Actual state: Off	If the hardware does not support the current state being read, this symbol is also used to clearly identify a fault case.
	Everything OK	
	Target state: On Actual state: Off	For example: The Solar-Log™ determined that the switch should be activated (e.g. surplus reached), but the command was not sent to the switch. This can only happen when the switching state can be read. => This state is temporarily valid, but not a longer period without a change (e.g. switch is processing commands).
	Target state: Off Actual state: On	For example: The Solar-Log™ determined that the switch should be deactivated (e.g. surplus too low), but the command was not sent to the switch. This can only happen when the switching state can be read. => This state is temporarily valid, but not a longer period without a change (e.g. switch is processing commands).
	Switch state: None Actual state: Unknown	The switch is not assigned to a group. => No target state. The switch state cannot be read or the switch is not available. => If no state can be read (hardware does not support this), everything is ok. => Otherwise the hardware is not available (fault).
	Target state: On Actual state: Unknown	The switch state can be read, but the hardware is unavailable.
	Error	
	Target state: Off Actual state: Unknown	The switch state can be read, but the hardware is unavailable.
	Error	
	Target state: None Actual state: On	The switch can be read, but the switch is not assigned to a group. => No target state.
	Everything OK	
	Target state: None Actual state: Off	The switch can be read, but the switch is not assigned to a group. => No target state.
	Everything OK	

The current switching states are display within a few second and are continuously updated.

Switch definitions

There is the option to assign one of the following states with a mouse click.

(See illustration: "Adjustable switch with help text"):

- All of the contacts are permanently switched off (switch position "left").
- The contacts are switched on according to the configured automatic switching rule.
- All of the contacts are permanently switched on (switch position "right").

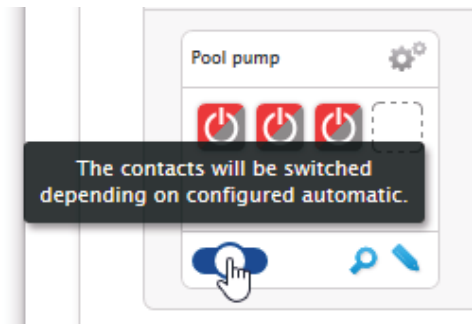

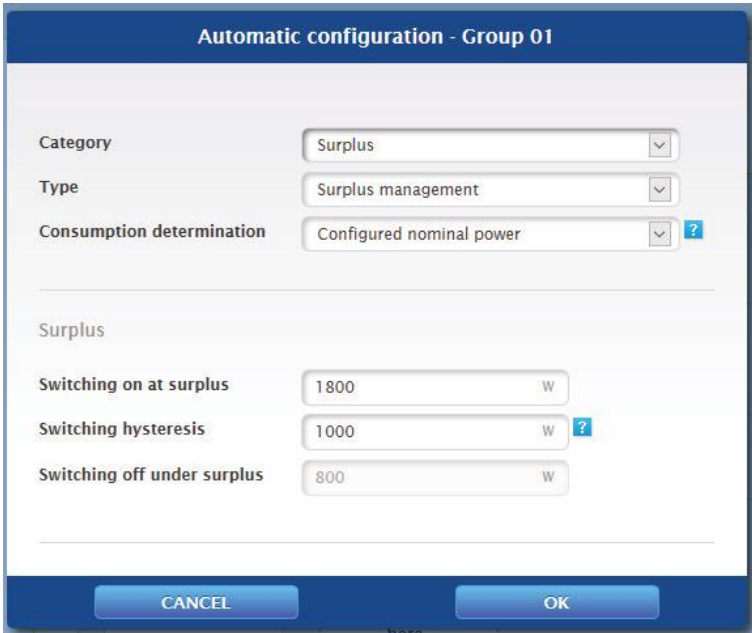

Fig.: Adjustable switch with help text

It is only possible to configure switching groups in the switch position "The contacts are switched according to the configured automatic switching rule". The editing pencil for the switching group is not visible for the other two options. If the switch is set to one of the other modes, the configured logic remains and is active once the mode has been set back. Click on the gear icon to change the name of the switching group, delete it or adjust the mode.

12.9.4 Configuring switching groups

Use this  symbol to configure the switching group. The following window appears after clicking on the symbol:



Automatic configuration - Group 01

Category: Surplus

Type: Surplus management

Consumption determination: Configured nominal power

Surplus

Switching on at surplus: 1800 W

Switching hysteresis: 1000 W

Switching off under surplus: 800 W

CANCEL OK

Fig.: Control logic configuration window

The configuration is divided into two sections. The top section contains the following boxes:

- Category
- Type and
- Consumption determination. If the Consumption meter option is selected for the Consumption determination, an additional selection box is displayed with all of the available (sub) consumption meters. For the temperature profiles, an additional selection box is displayed with all of the available temperature sensors.

The bottom section is automatically determined by the selected category.

12.9.5 Control Logics Definition - Operating Mode Appliances

Various control logics can be defined with the input boxes. (See the Smart Energy Manual for more details – available for download from our [Website](#).)

The individual boxes can be combined differently, depending on the control is used.

The following rules can be selected from the Category box:

- Surplus
- Production
- Consumption
- Device-specific
- Other

Depending on the rule, different types can be set.

Surplus

The following types can be configured under the Surplus category:

- Surplus management
- Surplus management and Temperature Control
- Surplus management and Time Control
- Surplus management and Runtime Control
- Surplus matrix
- Surplus visualization

Surplus management:

The following consumption definition can be selected in the Surplus management section:

- Configured nominal power:
Consumption is calculated from the configured nominal power for the contacts and the switch state. The nominal power can be configured under [Configuration | Device | Configuration](#). If it is available, the current state is used for the calculation; otherwise, the target state is used.
- Measured value from the contacts (can only be selected if at least one contact that provides output values has been assigned to the switching group. This depends on the hardware used and can be viewed by clicking on the magnifying glass icon in the hardware section under [Configuration | Smart Energy | Switching groups](#)):
Consumption is determined by the measured consumption from the individual contacts as long as these values are provided. This is determined by the configured nominal power for contacts that do not provide these values or when communication is offline.
- Consumption meter:
Consumption is determined by a separate consumption meter that has to be detected as a device. If this type of consumption determination is selected, the responsible consumption meters also have to be selected.

After the consumption determination has been selected, the threshold values have to be configured in the last step.

- Switching on at surplus (W).
- Switching hysteresis (W):
The switching hysteresis is to prevent that the switch will be permanently turned on/off at the threshold. It is recommended to have a hysteresis of 100 to 1000 W depending on the switch-on threshold.
- Switching off under surplus (W): (This value is grayed out and cannot be manually modified. It is calculated from the "Switching on at surplus [W]" value minus the "Switching hysteresis (W)" value.)

Surplus management and Temperature Control:

This Consumption determination is almost completely identical to that of Surplus management. The only difference is that the temperature sensor has to be selected.

After selecting the Consumption determination, the following sections are to be configured:

- Surplus and
- Temperature.

The Surplus configuration (see Surplus management).

The following settings can be made and/or activated under temperature configuration:

- Switch on when temperature is (C°):
 - greater
 - less
- Runtime (min.):

If the appliance was activated because of the temperature threshold, it will be deactivated after this time has passed, even if the minimum/maximum temperature has not been reached.
- Minimum/Maximum temperature (C°) (depends on the selection for "Switch on when temperature is (C°) greater or less"):

It is applied even if the appliances are activated because of a surplus or the temperature.

Surplus management and Time Control:

This Consumption determination is identical to Surplus management.

After selecting the Consumption determination, the following sections are to be configured:

- Surplus
- Time

The Surplus configuration (see Surplus management).

Up to two daily runtimes can be set in the time configuration. If only one runtime is needed, the second one can be deleted by clicking on the trash can symbol.

Surplus management and Runtime Control:

This Consumption determination is identical to Surplus management.

After selecting the Consumption determination, the following sections are to be configured:

- Surplus
- Daily runtime

The Surplus configuration (see Surplus management).

The following settings can be made and/or activated under Daily runtime configuration:

- Daily runtime [Min.] (this values is determined by the time from 0:00 to 23:59.)
 - Minimal
 - Exact
 - Maximal
- Fill runtime from:

Depending on the situation, it could happen that the period of time from the defined daily runtime could not fulfilled with the surplus rule. In this case, it can be defined in this box at which time the remaining daily runtime should be fulfilled. The process is also carried out when there is no surplus available.
- Minimum continuous switch on time (Min.).
- Minimum continuous switch off time (Min.).
- Max. switch on operations:

The remaining daily runtime is completely fulfilled with the last switching run.

Note



The daily runtime will be set to the value of the new day starting at 0:00 (midnight). That is why it is not possible to have a runtime extending past the particular day. The devices controlled in this section will be turned off at 0:00 (midnight).

Surplus matrix:

At least two and no more than three contacts have to be assigned to the switching group to use this function. This Consumption determination is identical to Surplus management.

In the bottom section, there is a matrix to determine the output of the appliances and with which contacts are linked to in the switching group.

Up to seven surplus levels can be created by clicking on the plus symbol.

Levels that are not needed can be deleted by clicking on the trash can symbol.

Surplus visualization:

With Surplus visualization, its own surplus threshold can be configured for every contact (1-8) assigned to the group.

Note



This function is only for the visualization and no loads may be switched on since the Solar-Log Base would then have incorrect calculations which would lead to faulty switching operations.

Production

With output visualization, its own output threshold can be configured for every contact (1-8) assigned to the group.

Note



This function is only for the visualization and no loads may be switched on since the Solar-Log Base would then have incorrect calculations which would lead to faulty switching operations.

Consumption

With Consumption visualization, its own consumption threshold can be configured for every contact (1-8) assigned to the group.

Note



This function is only for the visualization and no loads may be switched on since the Solar-Log Base would then have incorrect calculations which would lead to faulty switching operations.

Device-specific

The following types can be configured under the Device-specific category:

- Heat pump with a grid company blocking signal.
- Vaillant heat pump with a grid company blocking signal.
- Heating rod three level digital.

Heat pump with a grid company blocking signal:

Heat pumps can have a control input for a grid company blocking signal. This input is used by grid operators via ripple control receivers to release heat pumps at a certain time. If a heat pump can now be run with PV power, this input can be used to switch on the heat pumps in relation to the amount of power being produced. The relay is then turned off during periods with a PV surplus--when the heat pumps "may" run. When no PV surplus is available, the heat pumps remain deactivated. There are a maximum of three configurable periods available to avoid a cool down during periods with a longer deactivation, e.g. during periods of bad weather. During such periods, the heat pumps are enabled and - if required - power is purchased from the grid.

This profile is defined based on two thresholds and three periods of continuous operation. The periods of continuous operation are defined based on the:

- Time from/to and
- Month from/to

Vaillant heat pump with a grid company blocking signal

This control logic is especially pre-configured for Vaillant heat pumps. The function and configuration corresponds to the "heat pump with a grid company blocking signal" profile.

Heating rod three level digital

At least two and no more than three contacts have to be assigned to the switching group to use this function.

This Consumption determination is identical to Surplus management.

In the bottom section, there is a matrix to determine the output of the heating coil and with which contacts are linked to in the switching group.

Up to seven surplus levels can be created by clicking on the plus symbol.

Levels that are not needed can be deleted by clicking on the trash can symbol.

Other

The Automatic timer type under Other category operates independent of the current PV production and measured consumption.

Up to ten daily runtimes can be created by clicking on the plus symbol.

Levels that are not needed can be deleted by clicking on the trash can symbol.

Generation Information on Thresholds

Average values (every 5, 10 or 15 minutes) are generated to balance the fluctuations in PV production (e.g. due to clouds) for managing appliances. The average value is aligned to the threshold set in the respective logic control.

General information about nominal power (maximum AC output):

The nominal power (maximum AC output) is the average consumption of appliances that is controlled by the profile. Appliances, such a laundry dryer, have a short high peak of power consumption and times in which little power is required. Based on this, it would be problematic to calculate the current power consumption for power management control. This is why the Solar-Log™ calculates the entire runtime with the value configured for the nominal power (maximum AC output) which can be entered in the [Configuration | Devices | Configuration | Configuration](#) in the [Module Fields, Power Output and Descriptions](#) section. (See the Chapter "[Module Fields, Power Output and Descriptions](#)" under [Device Configuration](#).)

Note



The most exact that the configured nominal power (maximum AC output) corresponds to the actual consumption, the more accurately the control of consumption via Smart Energy is.

Note



The configured control rules can be simulated in the Diagnostics menu. Click on the arrow symbol at the top under [Configuration | Smart Energy | Switching groups](#) to switch directly to the Smart Energy Simulation.

(See the User Manual for more information about the Smart Energy Simulation.)

Note



A detailed document about Smart Energy with practical examples is available from our website in the [Products & Solutions](#) section.

12.9.6 Control Logics Definition - Operating Mode Generator

Various control logics can be defined with the input boxes.

The individual boxes can be combined differently, depending on the control is used.

The following rules can be selected from the Category box:

- Power from the grid
- Other

Power from the grid

The following types can be configured under the Grid Power category:

- Power from the grid
- Power from the grid and Time Control
- Power from the grid and Runtime Control

Power from the grid:

The following production definition can be selected in the Grid Power section:

- Configured nominal power:
Production is calculated from the configured nominal power for the contacts and the switch state. The nominal power can be defined in the [Module Fields, Power Output and Descriptions](#) section of the [Configuration | Devices | Configuration](#). If it is available, the current state is used for the calculation; otherwise, the target state is used.
- Measured value from the contacts (can only be selected if at least one contact that provides output values has been assigned to the switching group. This depends on the hardware used and can be viewed by clicking on the magnifying glass icon in the hardware section under [Configuration | Smart Energy | Switching groups](#)):
Production is determined by the measured production from the individual contacts as long as these values are provided. This is determined by the configured nominal power for contacts that do not provide these values or when communication is offline.
- Production meter:
Production is determined by a separate production meter that has to be detected as a device.

Section "Grid Power"

After the production determination has been selected, the threshold values have to be configured in the last step.

- Switching on at grid power (W).
- Switching hysteresis (W):
The switching hysteresis is to prevent that the switch will be permanently turned on/off at the threshold. It is recommended to have a hysteresis of 100 to 1000 W depending on the switch-on threshold.
- Switching off below production [W] (This value is grayed out and cannot be manually modified. It is calculated from the "Switching on at grid power (W)" value minus the "Switching hysteresis (W)" value.)

Power from the grid and Time Control:

This production determination is identical to that of the grid power.

After selecting the production determination, the following sections are to be configured:

- Power from the grid
- Time

The configuration of grid power (see the section "Grid Power" above).

Up to two daily runtimes can be set in the **Time** configuration. If only one runtime is needed, the second one can be removed by clicking on the trash can symbol. The runtimes can be defined beyond just one particular day.

Power from the grid and Runtime Control

This production determination is identical to that of the grid power.

After selecting the production determination, the following sections are to be configured:

- Power from the grid
- Daily runtime

The configuration of grid power (see the section "Grid Power" above).

The following settings can be made and/or activated under Daily runtime configuration:

- Daily runtime [Min.] (this values is determined by the time from 0:00 to 23:59.)
 - Minimal
 - Exact
 - Maximal
- Fill runtime from:

Depending on the situation, it could happen that the period of time from the defined daily runtime could not fulfilled with the surplus rule. In this case, it can be defined in this box at which time the remaining daily runtime should be fulfilled. The process is also carried out when there is no surplus available.
- Minimum continuous switch on time (Min.).
- Minimum continuous switch off time (Min.).
- Max. switch on operations:

The remaining daily runtime is completely fulfilled with the last switching run.

Note



The daily runtime will be set to the value of the new day starting at 0:00 (midnight). That is why it is not possible to have a runtime extending past the particular day. The devices controlled in this section will be turned off at 0:00 (midnight).

Other

The Automatic timer type under Other category operates independent of the current PV production and measured consumption.

Up to ten daily runtimes can be created by clicking on the plus symbol.

Levels that are not needed can be deleted by clicking on the trash can symbol.

12.9.7 Smart Energy Surplus Management

The Surplus Management menu is divided into the following sub-sections:

- Settings and
- Surplus priority.

(See illustration: "Surplus management")

Configuration / Smart Energy / Surplus management

The screenshot shows the 'SURPLUS MANAGEMENT' configuration page. It is divided into two main sections: 'Settings' and 'Surplus priority'.
Settings section:
 - 'Measurement values for control logic': A dropdown menu currently showing 'Average values'.
 - 'Surplus offset [%]': A text input field containing '70', followed by a secondary value '25899 W'.
 - 'Prevent battery charge': A toggle switch that is currently turned off, labeled 'Deactivated'.
 - 'Prevent battery discharge': A toggle switch that is currently turned off, labeled 'Deactivated'.
Surplus priority section:
 - 'Priority list': A list containing two items: 'BHKW' and 'ECO'.
 At the bottom right of the interface, there are two buttons: 'CANCEL' and 'SAVE'.

Fig.: Example – Surplus management

The following values can be defined in the [Settings](#) section:

- Measurement values for control logic.
- Surplus offset [%].
- Battery charging suspension (only displayed when a hybrid or battery system has been detected).
- Battery charging suspension (only displayed when a hybrid or battery system has been detected).

The following values for the control logic can be selected under [Measurement values for control logic](#):

- Current values:
are the instantaneous values. For systems with constant measurements values (e.g. CHP as producer), current values can also be used to react more quickly.
- Average values:
Average values compensate for power fluctuations and help the control logic to operate more steadily.

Note



Depending on the number of connected inverters, the average value is based on 5, 10 or 15 minute values.

< 30 INV: 5 minutes, 30-59 INV: 10 minutes, >= 60 INV: 15 minutes

Battery charging suspension:

When activated, the Solar-Log™ switches appliances on to prevent the battery from being charged. The battery will only be charged when the respective appliances are deactivated again or when there is still a power surplus despite the consumption from the appliances.

Battery discharging suspension:

When activated, the Solar-Log™ turns on the generators to provide enough power production to cover the amount required for consumption. This means that the battery is only discharged when the power production cannot cover the consumption.

Note



The “**Battery (dis)charging suspension**” options are only available when a hybrid or battery system has been detected and are deactivated unless production/consumption controls have been defined.

Surplus offset [%]:

How much nominal plant output is to be fed into the grid and how much should be used for the Surplus manage of the Smart Energy control logics can be defined in this box.

When output reduction is activated, a sensor has to be installed to determine the amount of theoretically available production.

In the **Surplus priority** section, the list of defined switching groups and the detected intelligent appliances are displayed according to their priority (the first entry in the list has the highest priority). This can be adjusted at anytime with the drag and drop function.

Note



The prioritization occurs only for the surplus profiles and not, for example, for the runtime control profiles.

12.10 Feed-In Management

Access Feed-in Management via the menu [Configuration | Feed-in Management](#).

In this section you have the possibility to implement the grid operator's requirements in regard to active and reactive power control.

Note



The Solar-Log™ is not equipped with protection functions such as grid and plant protection, section switches and Q/U protection. When it comes to such functions, special protection hardware needs to be installed. All protection commands, for example the emergency stop, cannot be switched on with or via the Solar-Log™.

12.10.1 Plant parameters

The plant data is entered in the plant parameters tab.

- Maximum apparent power from the generating plant
Enter the maximum plant power output in volt-ampere (VA) here. This value has to match the value registered with the grid company.
Typically, this calculation is based the total module power output.

When using the Utility Meter, these additional boxes need to be defined

- UC:
In this field the agreed grid voltage in the grid operator's medium-voltage network is entered. This value is specified by the grid operator. As a rule the network voltage at medium voltage levels corresponds to 20,000 V.
- UNS:
The reference voltage to be entered depends on the sensor used. The medium voltage measuring factory setting is 100.0 V for the Solar-Log™ Utility Meter.

UC and UNS settings

	Medium voltage Utility Meter (U)	Medium voltage Utility Meter (U+I)	Low voltage
UC	20000	20000	398
UNS	20000	20000	398

Note



In a master-slave setup, only the connected power on the particular device may be entered for each Solar-Log Base 2000.

Plant passwords

The log-on data can be entered for the inverters in the [Configuration | Feed-in Management | Plant Parameters | Plant Passwords](#) menu – as long as the devices configured support this function..

- Inverter Password:
Plant password, if service password is required to access the inverters.
- Log-on Mode:
If supported by the inverters, a difference can be made between normal and privileged access. With individual modules, privileged access can be required to gain access to power management functions.
- Parameter Password:
Password which is needed to change critical settings for the inverters, e.g. the GridGuard-Code for SMA inverters.

Note



Please make sure that the inverter password matches the log-on mode.
If separate passwords for an inverter can be assigned to users and installers, the corresponding password has to be assigned to the log-on mode.

Note



The Plant Password menu is only displayed when the inverters connected required a password to access the inverters and/or a password to change critical settings.

12.11 Active power

The following modes are available from the [Feed-in Management | Active power](#) menu:

- Deactivated
- Remote controlled (only with additional Mod I/O module)
- Remote controlled with the calculation of self-consumption (only with additional Mod I/O module)
- 70% fixed reduction
- 70% Fixed reduction with the calculation of self-consumption
- Adjustable reduction
- Adjustable reduction with the calculation of self-consumption
- Fixed reduction in watts
- Fixed reduction in watts with the calculation of self-consumption
- Percentage of consumption for an adjustable reduction

Note



The active power reduction mode that needs to be implemented for a particular PV plant is determined by the current national laws, standards and grid operator's requirements. The planner and/or installer of your plant or the respective grid operator can provide you with information regarding the mode of active power reduction that needs to be used.

Note



The feed-in management functions are not supported by all makes and models of inverters. Prior to installation please check whether power management and reactive power control are supported by the inverters used. Please consult our inverter database for an overview of all the inverters supported by Solar-Log™ devices and more details on supported functions of a particular inverter:

<https://www.solar-log.com/en/support/>.

Interface assignments section

The inverters with their assigned interfaces that are connected to the Solar-Log™ are displayed in this section. Select the inverter(s) to control and activate it/them.

LCD Display section (VLCD Display)

In the VLCD Display section, the values that are displayed can be defined.

The following values can be selected:

- Only error:
This is displayed when there are PM control errors.
- Target power (% DC):
This is the value (%DC) that has been selected for the reduction (e.g. 70%).
- Percentage of consumption (only selectable when the "Percentage of consumption for an adjustable reduction" has been defined under type):
Value that was entered for the "Percentage for an adjustable reduction." 100% is not visualized since the VLCD display can only display two digits (e.g. 70%).
- Control value power (% AC):
The control value is the value sent to the inverters in order to reach the target value. The relationship between the nominal power (AC) and the installed DC power (DC) is factored in. The current consumption from the control with self-consumption is also factored in.

The value of 100% is not displayed on the VLCD display.

Dynamic control for different module orientations

Depending on the plant, there might be different module orientations. To integrate these differences with the active power, the switch "Dynamic control for different module orientations" needs to be activated (deactivated by default). This switch is located in the [Feed-In Management | Active Power](#) menu. Activate this.

When this option is activated, different reduction commands are sent to the inverters, e.g. taking their orientation into consideration, to maximize the amount of power fed into the grid without exceeding the limit. The advantage here, for example, is that when some inverters are performing below a 70% limit, the output from other inverters can be adjusted above the 70% to balance the final output to 70%.

12.11.1 Active power deactivated

When this menu item is selected, active power is deactivated. After that, the controllable interfaces can be selected when control is via the Modbus PM or via a PM Profile.

12.11.2 Remote controlled Active Power Restriction (only with additional Mod I/O module)

This option should be selected if you want the active power reduction to be remotely controlled by the grid operator.

To enable this function, a ripple control receiver or similar device is required. Typically, these devices are provided by the grid operator for a fee.

The type of ripple control receiver or telecontrol technology used depends on the level of development of the respective grid operator. The control signals emitted by the grid operator are converted to potential-free signal contacts by the ripple control receiver and can be evaluated by the Solar-Log™ PM+ models via the digital PM+ interface.

Note



The function of the PM+ interface is only possible when the contacts of the ripple control receiver are potential free and are wired with a supply voltage of 5VDC from the PM+ interface.

Examples of ripple control receiver connections and the corresponding configuration are in the chapter "[Appendix](#)".

Channel settings for power reduction section

The relay outputs for the ripple control receiver are connected to the PM+ input of the Solar-Log™ PM+. This allows the grid operator's signals to be evaluated by the Solar-Log™.

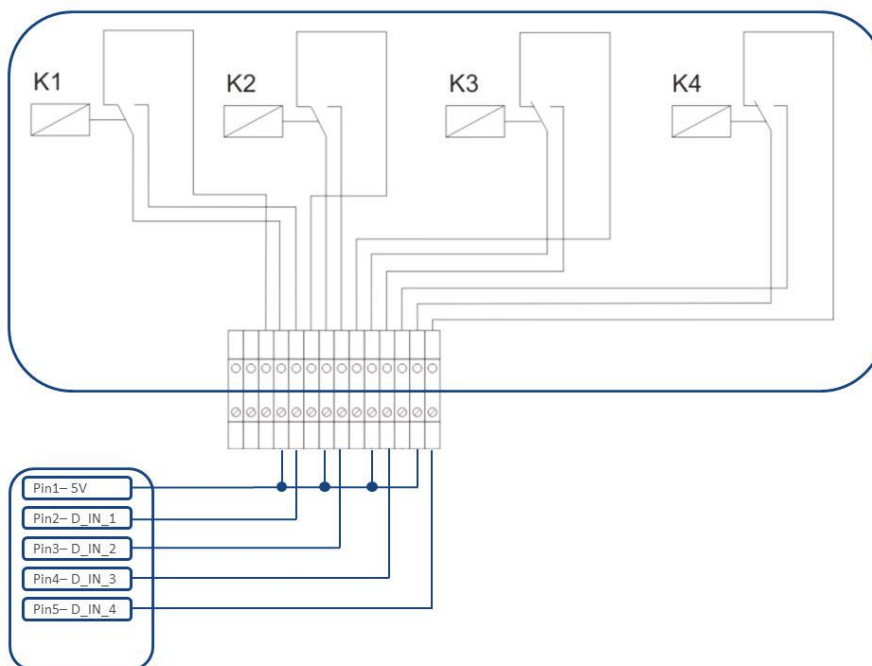

Fig.: Schematic diagram of a ripple control receiver with four relays.

The relay for active power control is wired to the PM+ interface.

Note



The function of the PM+ interface is only possible when the contacts of the ripple control receiver are potential free and are wired with a supply voltage of 5VDC from the PM+ interface.

In practice, various ripple control receivers with varying numbers of relays and different signal codes are used. The configuration matrix for the Solar-Log™ PM+ thus offers maximum flexibility – most common versions can be configured.

Ripple control receivers generally possess 2 to 5 relays. The assignment of the individual relay states for certain reduction levels is specified by the respective network operator and stored in the Solar-Log™ using this matrix. In this way the connected inverters can be adjusted to meet the specified reduction levels.

Channel settings for power reduction

Digital input	D_IN_1	D_IN_2	D_IN_3	D_IN_4	Power in %
Level 1	<input checked="" type="checkbox"/>	<input type="checkbox"/>	<input type="checkbox"/>	<input type="checkbox"/>	100
Level 2	<input type="checkbox"/>	<input checked="" type="checkbox"/>	<input type="checkbox"/>	<input type="checkbox"/>	60
Level 3	<input type="checkbox"/>	<input type="checkbox"/>	<input checked="" type="checkbox"/>	<input type="checkbox"/>	30
Level 4	<input type="checkbox"/>	<input type="checkbox"/>	<input type="checkbox"/>	<input checked="" type="checkbox"/>	0

Fig.: Channel settings for power reduction

For each level, the input signal combination and a value for the power in % is entered.

Checking the box next to the digital inputs of the PM+ interface (D_IN_1 to D_IN_4) means that these inputs are supplied with 5V from pin1 to reduce to the percentage of the set in the box "Power in %".

Four levels are shown in the basic setting. The "+" sign can be used to extend the list by additional levels.

Procedure:

- Select [remote controlled](#).
- Select the inverter(s) to control in the [Interface assignments](#) section.
- Enter the [channel settings for power reduction](#) according to the specifications and wiring.
- Select [options](#).
- **SAVE** the settings.

More Options

Closing relays at level 4 ([only Solar-Log 1200 PM+, 1900 PM+ and 2000 PM+](#)).

By selecting this function the potential-free control relay for the Solar-Log PM+ is closed when level 4 is activated.

- The relay may be loaded with a maximum of 24 V DC and 5A.
- A 230 V appliance has to be connected via another load relay.

Please also refer to the additional information on relays in Seite 59 of this installation manual.

Closing relay during power reduction ([only Solar-Log 1200 PM+, 1900 PM+ and 2000 PM+](#)).

Select this option in order to signal any power reduction via the relay output on the Solar-Log PM+*.

- The relay may be loaded with a maximum of 24 V DC and 5A.
- A 230 V appliance has to be connected via another load relay.

Max. change in power in %:

A jerky reduction or increase in active power could have a negative impact on inverters in the long-term.

The "max. change in power" field is used to specify how high the maximum percentage change in power is per period of time (15 seconds).

This value refers to the power reduction but is also used when starting up the plant after a power reduction.

Note



The notifications per e-mail for active power reductions can be activated from the [Configuration | Notifications | PMmenu](#).

12.11.3 Remote controlled reactive power restriction with the calculation of self-consumption (only with additional Mod I/O module)

This function is an enhancement to the [Remote controlled active power reduction](#) function described in the previous chapter. This function does not correspond to provisions of the German EEG laws and has to be arranged with the grid operator before being used.

Note



The Solar-Log PM+ needs to be linked to a consumption meter to implement this function. Please note the instructions in chapter „12.5 Externe Stromzähler“.

The configuration of this corresponds to that already described for the remote controlled active power reduction. The instruction for integrating the meters into the electric wiring of the house or building are found in the [appendix](#).

Notes about the function



Self-consumption is taken into account with a command (less than 100% and greater than 0%). The inverter(s) supply a higher output than the command value by taking the current consumption into account.

Self-consumption is not taken into account with the 0% command value. As a safeguard here, the plant is always limited to 0%.

12.11.4 70% fixed reduction

By activating this menu item the inverter(s) are controlled to be fixed at 70% of the installed DC power. Enter the [Maximum AC Power](#) and [Connected Generator Power](#) as reference values in the [Configuration | Devices | Configuration](#) menu.

The maximum power output for the inverters can be calculated from the connected generator power value that has been entered.

Procedure

- Select 70% fixed reduction.
- Select the inverter(s) to control in the [Interface assignments](#) section.
- SAVE the settings.

Note



Changes to the [Maximum AC Power](#) of the inverter in [Configuration | Devices | Configuration](#) menu are disabled.

Enter your password via the Log-on as Installer / PM to enable changes.

Note



The 70% reduction is always applied to the entire plant.

All of the inverters are controlled on the same level by the Solar-Log™, independent of their alignments (east-west orientation). This can lead to a lower feed-in amount than the maximum allowed.

Example 1

DC power 12 kWp

AC power 12 kW

70% of the DC power corresponds to 8.4 kW

As the AC and DC power are identical, the down-control is correct.

Example 2

DC power 12 kWp

AC power 10kW

70% of the DC power corresponds to 8.4 kW

For this reason the inverter controlled by the Solar-Log™ is reduced to 84% (8.4 kW) and not only to 70% (7 kW).

12.11.5 70% Fixed reduction with the calculation of self-consumption

This function is an enhancement to the 70% fixed reduction described in the previous chapter.

The Solar-Log™ needs to be linked to a consumption meter to implement this function. Please note the instructions in the chapter "[11.5 External Power Meters.](#)"

The configuration of this corresponds to that already described for the 70% fixed reduction.

Procedure:

- Select 70% Fixed reduction with the calculation of self-consumption
- Select the inverter(s) to control in the [Interface assignments](#) section.
- SAVE the settings.

Note



The Solar-Log™ needs to be linked to a consumption meter to implement this function. Please note the instructions in the chapter "[11.5 External Power Meters.](#)"

The current amount of self-consumption is calculated by employing a power meter for self-consumption. The

consumption is calculated with the energy generated by the inverter.

If the difference between the current production and consumption is lower than 70% of the module's power output, the inverters are regulated accordingly, so that the amount of power at the feeding point is still only at 70% of the connected generator power.

12.11.6 Adjustable reduction

This function allows the maximum amount of grid feed-in power to be configured. The reduction level in regard to the amount of connected generator power can be freely defined as a percentage (X%). The Solar-Log™ only regulates the inverters when the amount of feed-in power for the grid has reached the limit.

Procedure:

- Select Adjustable reduction.
- Enter the **percentage** for the adjustable reduction.
- Select the inverter(s) to control in the **Interface assignments** section.
- **SAVE** the settings.

12.11.7 Adjustable Reduction with the Calculation of Self-Consumption

This function allows the maximum amount of grid feed-in power to be configured. The reduction level in regard to the amount of connected generator power can be freely defined as a percentage (X%). The amount of self-consumption is taken into account for this calculation. The Solar-Log™ only regulates the inverters when the amount of feed-in power for the grid has reached the limit. If there is enough self-consumption, the inverters continue to operate without any reductions.

Procedure:

- Select Adjustable reduction with the calculation of self-consumption
- Enter the **percentage** for the adjustable reduction.
- Select the inverter(s) to control in the **Interface assignments** section.
- **SAVE** the settings.

Note



The Solar-Log™ needs to be linked to a consumption meter to implement this function. Please note the instructions in the chapter "[11.5 External Power Meters.](#)"

12.11.8 Fixed reduction in watts

This function allows the maximum amount of grid feed-in power to be configured. The reduction level in regard to the amount of connected generator power can be freely defined to a particular output level (W). The Solar-Log™ only regulates the inverters when the amount of feed-in power for the grid has reached the limit.

Procedure:

- Select Adjustable reduction.
- Enter the **Output (W)** for the adjustable reduction.
- Select the inverter(s) to control in the **Interface assignments** section.
- **SAVE** the settings.

12.11.9 Fixed reduction in watts with the calculation of self-consumption

This function allows the maximum amount of grid feed-in power to be configured. The reduction level in regard to the amount of connected generator power can be freely defined to a particular output level (W). The amount of self-consumption is taken into account for this calculation. The Solar-Log™ only regulates the inverters when the amount of feed-in power for the grid has reached the limit. If there is enough self-consumption, the inverters continue to operate without any reductions.

Procedure:

- Select Adjustable reduction with the calculation of self-consumption
- Enter the **Output (W)** for the adjustable reduction.
- Select the inverter(s) to control in the **Interface assignments** section.
- **SAVE** the settings.

Note



The Solar-Log™ needs to be linked to a consumption meter to implement this function. Please note the instructions in the chapter "[11.5 External Power Meters.](#)"

12.11.10 Percentage of consumption for an adjustable reduction

This function allows the maximum amount of power generated by the inverter to be configured. The percentage configured (freely adjustable) results in a corresponding reduction in regard to the total consumption at the inverter.

Example:

The total consumption of an installation is at 2000 W and the reduction of the inverters is configured to 90%, leaving 1800 W. 200 W has to be purchased from the grid to cover the total consumption.

Procedure:

- Select the percentage of consumption for the adjustable reduction.
- Enter the **percentage (%)** for the adjustable reduction.
- Select the inverter(s) to control in the **Interface assignments** section.
- **SAVE** the settings.

Note



The Solar-Log™ needs to be linked to a consumption meter to implement this function. Please note the instructions in the chapter "[11.5 External Power Meters.](#)"

12.12 Reactive Power

The following modes are available from the [Feed-in Management | Reactive power](#) menu:

- Deactivated.
- Fixed value $\cos(\Phi)$ shift factor.
- Fixed reactive power in Var.
- Variable $\cos(\Phi)$ shift factor over characteristic curve P/Pn.
- Variable shift factor $\cos(\Phi)$ (U) (only Solar-Log Base 2000 with Utility Meter).
- Variable reactive power via the characteristic curve Q(U) (only Solar-Log Base with Utility Meter)
- Remote controlled variable shift factor $\cos(\Phi)$ (only with additional Mod I/O module).

Note



The active power reduction mode that needs to be implemented for a particular PV plant is determined by the national laws and guidelines. The planner and/or installer of your plant or the respective grid operator can provide you with information regarding the method of reactive power control.

Note



The feed-in management function is not available for all supported inverters. Prior to installation please check whether PM+ is supported by the inverters used. Additional information as well as our component database can be found at <https://www.solar-log.com/en/support>.

Note



The configuration for reactive power is always emanated from the reference direction, from the side of the Solar-Log™. The power companies define the requirements from their point of view. PV plants are usually defined in the consumption direction (with negative totals). For more information, refer to http://en.wikipedia.org/wiki/Electric_current#Reference_direction

Interface assignments section

The inverters with their assigned interfaces that are connected to the Solar-Log™ are displayed in this section. Select the inverter(s) to control and activate it/them.

12.12.1 Reactive power deactivated

When this menu item is selected, reactive power control is deactivated. After that, the controllable interfaces can be selected when control is via the Modbus PM or via a PM Profile.

12.12.2 Fixed value cos (Phi) shift factor

With this function it is possible to adjust the connected inverters to a fixed shift factor.

Using this matrix it is possible to specify a fixed cos (Phi) for certain periods of time. If over the course of one day various shift factors must be adhered to, they can be configured here. If an Utility Meter with power measurement is available, the measurements can be performed at the feeding point.

Procedure:

- Select Fixed value cos (Phi) shift factor.
- Activate the interface assignments to control.
- Enter the from (time).
- Enter the cos (Phi) for this time period.
- Check the box Inductive/under-excited changeover for cos (Phi).
- If necessary, enter additional times and the accompanying cos (Phi).
- If necessary, activate measuring at the feeding point.
- SAVE the settings.

If a certain cos (Phi) must be maintained for 24 hours, the time 00:00 as well as the cos (Phi) have to be entered in the first line. The other lines must also be filled with 00:00. It is not necessary to enter the cos (Phi).

12.12.3 Fixed reactive power in Var

Reactive Power Management

This function allows the connected inverters to generate a certain reactive power in Var for a definable period of time.

Procedure:

- Select Fixed reactive power in Var.
- Activate the interface assignments to control
- Enter the from (time).
- Enter the Reactive power for this time period.
- Check the box Inductive/under-excited for reactive power.
- If necessary, enter additional times and the accompanying reactive power
- SAVE the settings.

If a specific reactive power in Var must be supplied for 24 hours, the time 00:00 as well as the value in Var have to be entered in the first line and the the box inductive changeover has to be checked. The other lines must also be filled with 00:00. It is not necessary to enter reactive power.

Reductions

The following configuration options are available in the Reductions section.

- Max. cos (Phi) inductive/under-excited and max. cos(Phi) capacitive/over-excited:
A maximum shift factor can be defined with this the reduction. With this, it can be that less reactive power is fed-in into the grid than allowed in the partial load range in order to maintain the shift factor limits.

Note



Entering zero as the value deactivates the particular limit.

12.12.4 Variable cos (Phi) shift factor over characteristic curve P/Pn

The function allows the cos (Phi) to be adjusted according to characteristic curve P/Pn.

With a characteristic curve P/Pn, the ratio of the currently generated power (P) to nominal power (maximum output) (Pn) is determined. A cos (Phi) is assigned to ratio by a characteristic curve.

The function is also referred to as cos (Phi) (P).

The currently generated power (P) is calculated by the Solar-Log™ based on the inverter data. If an Utility Meter with power measurement is available, the output value will be used instead.

Note



Please check that all of the Solar-Logs in a master/slave setup have the same firmware version, especially for the characteristic curve P/Pn with the Utility Meter.

Type of characteristic curve section

Using this menu item a characteristic curve specified by the grid operator can be stored. In principle a distinction is made here between a 2-point and a 4-point characteristic curve.

2-point characteristic curve

By selecting "2-point characteristic curve" it is possible to define a characteristic curve using two points.

Procedure

- Select **Variable cos (Phi) shift factor over characteristic curve P/Pn** from the menu.
- Activate the **interface assignments** to control.
- Select **2-point characteristic curve**.
- Adjust the **characteristic curve points A and B** based on the boxes U/Uc, cos(Phi) and put a check in front of inductive/under-excited.
- **SAVE** the settings.

The characteristic curve displayed changes according to the values entered.

4-point characteristic curve

By selecting "4-point characteristic curve" it is possible to define a characteristic curve using four points.

Procedure

- Select Variable $\cos(\Phi)$ shift factor over characteristic curve P/Pn from the menu.
- Activate Interfaces.
- Select 4-point characteristic curve.
- Adjust the characteristic curve points A, B, C and D based on the boxes P/Pn, $\cos(\Phi)$ and put a check in front of inductive/under-excited.
- **SAVE** the settings.

The characteristic curve displayed changes according to the values entered.

12.12.5 Variable shift factor $\cos(\Phi)$ (U)

In order to be able to achieve this function, the Solar-Log™ Utility Meter is required in addition to the Solar-Log Base.

Reactive Power Management

The Solar-Log™ Utility Meter is linked to the Solar-Log™ via the RS485 bus and continually transmits the measured voltage values to the Solar-Log™. The measured values can be recorded at either the low or medium voltage side (when the corresponding converter and its configuration are present). Using the stored characteristic curve the Solar-Log™ continually calculates the reactive power to be supplied and controls the connected inverter accordingly.

Note



Information on connecting and configuring the Utility Meter is found in the „Installation Utility Meter“ section.

Type of characteristic curve section

Using this menu item a characteristic curve specified by the grid operator can be stored. In principle a distinction is made here between a 2 point and a 4 point characteristic curve.

2-point characteristic curve

By selecting "2-point characteristic curve" it is possible to define a characteristic curve using two points.

Procedure

- Select the type variable shift factor $\cos(\Phi)$ (U).
- Activate the interface assignments to control.
- Select 2-point characteristic curve.
- Adjust the characteristic curve points A and B based on the boxes U/Uc, $\cos(\Phi)$ and put a check in front of inductive/under-excited.
- **SAVE** the settings.

The characteristic curve displayed changes according to the values entered.

4-point characteristic curve

By selecting "4-point characteristic curve" it is possible to define a characteristic curve using four points.

Procedure:

- Select the type variable shift factor $\cos(\Phi)$ (U).
- Activate the interface assignments to control.
- Select 4-point characteristic curve.
- Adjust the characteristic curve points A, B, C and D based on the boxes U/Uc, $\cos(\Phi)$ and put a check in front of inductive/under-excited.
- SAVE the settings.

The characteristic curve displayed changes according to the values entered.

12.12.6 Variable reactive power via the characteristic curve Q(U)

In order to be able to achieve this function, the Solar-Log™ Utility Meter is required in addition to the Solar-Log Base.

Reactive Power Management

The Solar-Log™ Utility Meter is linked to the Solar-Log™ via the RS485 bus and continually transmits the measured voltage values to the Solar-Log™. The measured values can be recorded at either the low or medium voltage side (when the corresponding converter and its configuration are present). Using the stored characteristic curve the Solar-Log™ continually calculates the reactive power to be supplied and controls the connected inverter accordingly.

Note



Information on connecting and configuring the Utility Meter is found in the „Installation Utility Meter“ section.

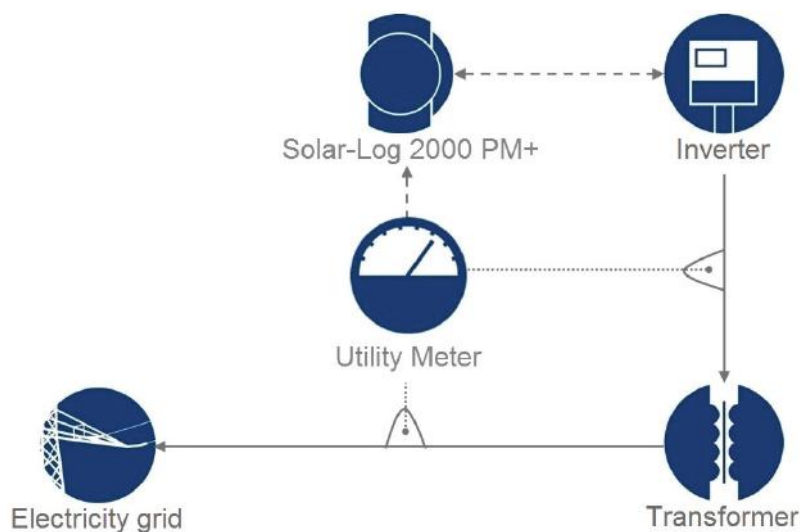

Fig.: Q(U) control function diagram example

Type of characteristic curve section

Using this menu item a characteristic curve specified by the grid operator can be stored. In principle a distinction is made here between a 2 point and a 4 point characteristic curve.

2-point characteristic curve

By selecting "2-point characteristic curve" it is possible to define a characteristic curve using two points.

Procedure:

- Select Variable reactive power via the characteristic curve $Q(U)$ as the type.
- Activate the interface assignments to control.
- Select 2-point characteristic curve.
- Adjust the characteristic curve points A and B based on the boxes U/U_c , Q/S_{Amax} and put a check in front of inductive/under-excited.
- SAVE the settings.

The characteristic curve displayed changes according to the values entered.

4-point characteristic curve

By selecting "4-point characteristic curve" it is possible to define a characteristic curve using four points.

Procedure:

- Select variable reactive power via the characteristic curve $Q(U)$ as the type.
- Activate the interface assignments to control.
- Select 4-point characteristic curve.
- Adjust the characteristic curve points A, B, C and D based on the boxes U/U_c , Q/S_{Amax} and put a check in front of inductive/under-excited..
- SAVE the settings.

The characteristic curve displayed changes according to the values entered.

Reductions

The following configuration options are available in the Reductions section.

- Gradient limit (adjustment rate):
If the power company requires a reduction, it has to be configured in this box. (Enter the values in seconds).
- Max. cos(Phi) inductive/under-excited and max. cos(Phi) capacitive/over-excited:
A maximum shift factor can be defined with this the reduction. With this, it can be that less reactive power is fed-in into the grid than what the characteristic curve allows in the partial load range in order to maintain the shift factor limits.

Note



Entering zero as the value deactivates the particular limit.

12.12.7 Remote controlled variable shift factor cos(Phi) (only with additional Mod I/O module)

This option allows the cos(Phi) shift factor to be remotely controlled by the grid operator. To enable this function, a ripple control receiver or similar device is required. Typically, these devices are provided by the grid operator for a fee.

The type of ripple control receiver or telecontrol technology used depends on the level of development of the respective grid operator. The control signals emitted by the grid operator are converted to potential-free signal contacts by the ripple control receiver and can be evaluated by the Solar-Log™ PM+ models via the digital PM+ interface.

Note



The ripple control receiver's potential-free commands have to be present for the duration of the command. Command impulses cannot be processed.

Channel settings for power reduction section

The relay outputs for the ripple control receiver are connected to the PM+ input of the Solar-Log™. This allows the grid operator's signals to be evaluated by the Solar-Log™.

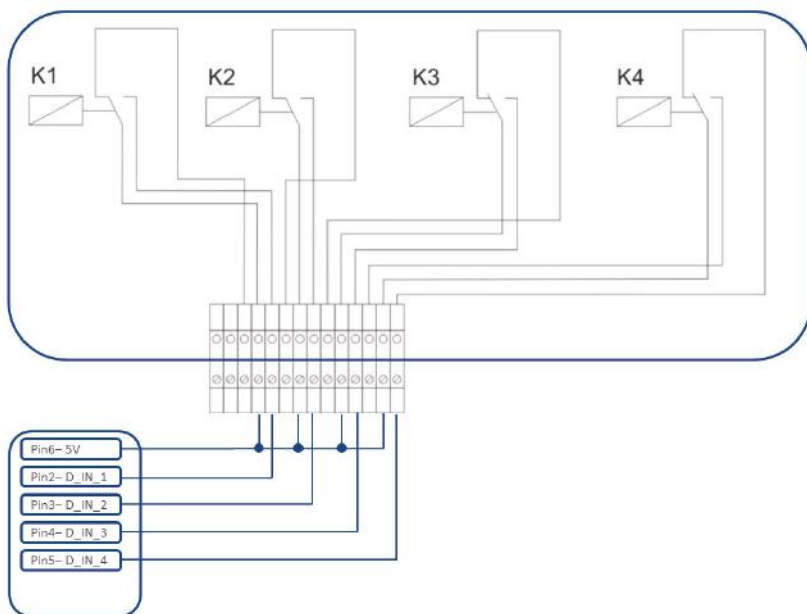

Fig.: Schematic diagram of a ripple control receiver with four relays.
 The relay for reactive power control is wired to the PM+ interface.

Note



The function of the PM+ interface is only possible when the contacts of the ripple control receiver are potential free and are wired with a supply voltage of 5VDC from the PM+ interface.

In practice, various ripple control receivers with varying numbers of relays and different signal codes are used. The configuration matrix for the Solar-Log™ PM+ thus offers maximum flexibility – most common versions can be configured.

Ripple control receivers generally possess 2 to 5 relays. The assignment of the individual relay states for a particular shift factor is specified by the respective grid operator and stored in the Solar-Log™ using this matrix. In this way the connected inverters can be adjusted to meet the specified reduction levels.

Channel assignment for reactive power control

Digital input	D_IN_1	D_IN_2	D_IN_3	D_IN_4	Cos(Phi)	Phase shift ?
Level 1	<input checked="" type="checkbox"/>	<input type="checkbox"/>	<input type="checkbox"/>	<input type="checkbox"/>	0.970	capacitive/overexcited <input type="checkbox"/> Inductive/under-excited <input checked="" type="checkbox"/>
Level 2	<input type="checkbox"/>	<input checked="" type="checkbox"/>	<input type="checkbox"/>	<input type="checkbox"/>	1.000	capacitive/overexcited <input type="checkbox"/> Inductive/under-excited <input checked="" type="checkbox"/>
Level 3	<input type="checkbox"/>	<input type="checkbox"/>	<input checked="" type="checkbox"/>	<input type="checkbox"/>	0.970	capacitive/overexcited <input type="checkbox"/> Inductive/under-excited <input checked="" type="checkbox"/>

Fig.: Channel settings for remote controlled cos (Phi)

For each level, the input signal combination and a value for the shift factor in cos (Phi) is entered. Checking the box next to the digital inputs of the PM+ interface (D_IN_1 to D_IN_4) means that the input is supplied with 5V from pin 6 to reduce the output on the cos phi defined in the box "cos (Phi)". One level is shown in the basic setting. The "+" sign can be used to extend the list by additional levels.

Procedure:

- Select remote controlled.
- Select the inverter(s) to control in the Interface assignments section.

- Enter the **channel settings** for power reduction according to the specifications and wiring.
- Select options.
- **SAVE** the settings.

More Options

Switching from the remote-controlled cos (Phi) to the possible characteristic curves can be implemented via assigned combinations of signals to the PM+ interface.

Channel assignment for reactive power control

Digital input	D_IN_1	D_IN_2	D_IN_3	D_IN_4	Cos(Phi)	Phase shift ?
Level 1	<input checked="" type="checkbox"/>	<input type="checkbox"/>	<input type="checkbox"/>	<input type="checkbox"/>	0.970	capacitive/overexcited <input checked="" type="checkbox"/> inductive/under-excited <input type="checkbox"/>
Level 2	<input type="checkbox"/>	<input checked="" type="checkbox"/>	<input type="checkbox"/>	<input type="checkbox"/>	1.000	capacitive/overexcited <input checked="" type="checkbox"/> inductive/under-excited <input type="checkbox"/>
Level 3	<input type="checkbox"/>	<input type="checkbox"/>	<input checked="" type="checkbox"/>	<input type="checkbox"/>	0.970	capacitive/overexcited <input checked="" type="checkbox"/> inductive/under-excited <input type="checkbox"/>
Level 4	<input checked="" type="checkbox"/>	<input checked="" type="checkbox"/>	<input checked="" type="checkbox"/>	<input checked="" type="checkbox"/>		
Level 5	<input type="checkbox"/>	<input type="checkbox"/>	<input type="checkbox"/>	<input type="checkbox"/>		

Variable cos (Phi) shift factor over characteristic curve P/Pn

Variable reactive power via a characteristic curve Q(V) in steps

Fig.: Switching to reactive power characteristic curves with certain signals

If a switch to the characteristic curve operating mode (P/Pn and Q(U)) is required due to a certain ripple control receiver signal, the respective levels for the switch can be entered in the input box. The fields have to be deactivated if there is to be no switching.

When the switch is activated, the configuration page reloads itself. The corresponding characteristic curves need to be defined. The settings for the characteristic curves correspond to the procedures described in the chapter „12.12.6 Variable Blindleistung über Kennlinie Q(U)“ .

12.12.8 Linking - Master/Slave (Solar-Log Base 2000)

The linking function is to be used when there are not enough interfaces on one Solar-Log™ or the cable lengths between the Solar-Log™ and the various inverters exceeds the RS485 specifications.

The link between the data loggers is established with an Ethernet connection. This TCP/IP connection can be established with various technologies such as fiber optics, wireless LAN, radio relay. For the Solar-Log™ network it is only relevant that the connection is fast and reliable.

The master within Solar-Log™ network always has to be a Solar-Log Base 2000. The Solar-Log Base 2000, Solar-Log™ 1200, 1900 and 2000 can be used as slaves.

The link is used to exchange control commands and responses between the Solar-Log™ devices. Each Solar-Log™ has to transfer yield data itself to a server.

Procedure:

- Select configuration from [Configuration | Feed-in Management | Networking](#) .
- Enter the IP address of the first slave.
- Click next to the box with the mouse.
- After entering the IP address an additional input box appears.
- A **maximum of nine slaves** can be active inside of a network.
- **SAVE** the settings.

Device no.	IP address	Last response
1	192.168.172.17	23.07.15 15:11:52
2	0.0.0.0	

Fig.: Solar-Log™ network configuration

Note



If there are no inverters connected to the master in the master/slave mode, the plant parameter under [Configuration | Feed-in Management | Plant parameters](#) and forecast value under [Configuration | Plant | Forecast](#) have to be set to 0.

12.12.9 Profile

Note



For certain PM profiles the use is only possible with additional module Mod I/O.

For feed-in management, PM+ profiles come with the Solar-Log™ PM Package equipment. These profiles contain the pre-configured settings for feed-in management and enable the PM+ Package I/O Boxes. The profiles are provided in the `config_pmprofil_NameNetzbetreiber.dat` file format.

Procedure:

- Select configuration from [Configuration | Feed-in Management | Profile](#),
- Click on [Browse](#) to import the profile and select the file to [open](#) it.
- Select load profile.
- The Solar-Log™ reboots itself. The status is displayed in the progress bar.

The following window appears after the reboot.

Fig.: Activated PM+ Profile for a PM Package

- The name of the grid operator / profile are displayed in the [Current Profile](#) section
- At the bottom of the page, the [I/O Boxes](#) that are used in the corresponding PM+Package are displayed.
- In the interface section, the RS485 interfaces or Master/Slave on which the [I/O Boxes](#) are [connected to](#) have to be selected.
- [SAVE](#) the settings.

Note



If a new PM+Profile needs to be imported, the current profile has to be reset first.

Note



A special operator specific installation manual is included for the installation of the PM+ Package.

12.13 ModbusTCP PM

The Modbus TCP PM interface can be activated in this menu. Activation creates a 30-day installation license. Please note that a license needs to be purchased to use the function after 30 days.

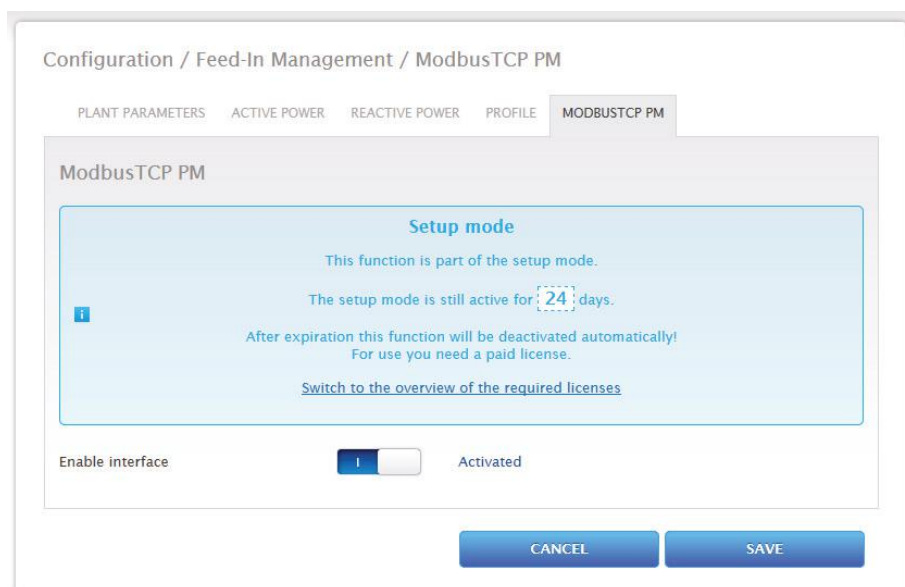

Fig.: Modbus TCP PM activated

12.14 Direct Marketing

To activate Direct Marketing, go to the menu [Configuration | Direct Marketing](#) and set the remote control option to [Modbus](#). After that, a direct marketing package (.bdl) can be loaded under "Integrated OpenVPN Tunnel). For this option, the proper direct marketing package for the plant has to be ordered from Solare Datensysteme GmbH. Once the package has been ordered and is ready to be downloaded, it can be imported via "Upload File." After the file has been imported, the VPN tunnel connection is established and the connection to the direct marketer is started.

Click on the "Stop" button to cancel the direct marketer connection. The package can be removed by clicking on "De-install." There is also the option to download the log file by clicking on the "Download" button in the Log section. This file logs the connection to the direct marketer via the VPN tunnel. (Refer to the figure below.)

Note



When the “Remote control option: Modbus” is activated, a 30-day installation license is created. If the function is used after the 30-day, the license needs to be purchased. (Refer to the chapter “Licenses”)

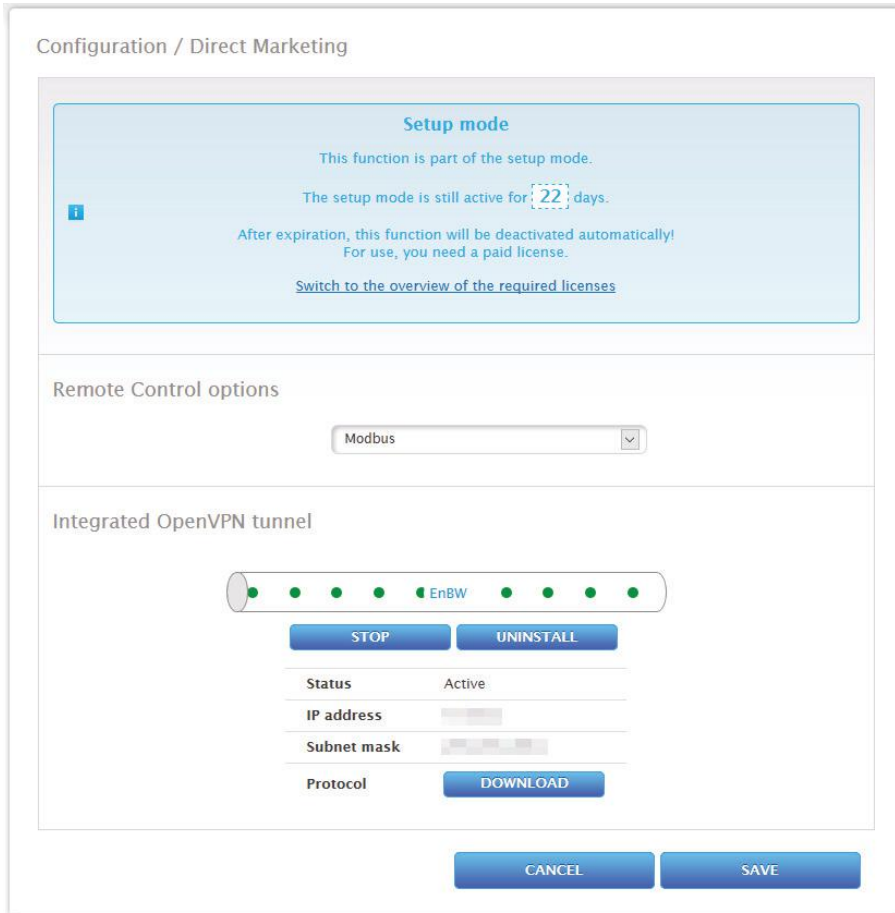

Fig.: Direct marketing with imported example package

12.15 Data

The [Configuration | Data](#) menu offers several functions in regard to the data recorded by the Solar-Log™ and contains the following options:

- Initial yield
- Data correction
- System backup
- Backup
- Reset

12.15.1 Initial yield

This function manually imports initial yields from previous recorded daily data into the Solar-Log. This is useful any time that a large amount of data has to be changed and would take too long with the "Data correction" function. The Data import deletes the existing data memory completely before the daily data is imported from a CSV file. Therefore, the data import should be carried out immediately after the startup of Solar-Log™. The Initial yield can contain production, consumption or self-consumption values.

Note



A data import can only be made if all inverters have been correctly detected and configured or if a valid system configuration has been imported.

The data has to be in the CSV format for the import. Files in the CSV format can be created with simple text editors or spreadsheet programs like MS Excel or Open Office Calc.

The import file must consist of individual rows of text, in which the date and daily yield value in "Wh" (not kWh!) are separated by semicolons (CSV format).

Example:

DD.MM.YY; Production in Wh; Consumption in Wh; Self-consumption in Wh

27.08.19;136435;264371;33684

28.08.19;138219;213145;43476

etc.

Note: Here, the year value should also consist of 4 digits.

Procedure:

- Click on [Browse](#).
- The file manager of your OS appears.
- [Select the CSV file](#) that is to be imported
- The selected file name is displayed
- Click on [Upload](#).
- The progress and status of the data import are displayed.
 - Upload file
 - End current measuring
 - Delete all of the old data and initialize structure
 - Import daily data
 - Calculate monthly/yearly data
 - restart
- The Solar-Log™ resets itself.
- Check the imported data in the yield data section.

12.15.2 Data correction

Here you can adjust the values for previous days or change daily totals.

Procedure

- Enter a 6-digit date
DD/MM/YY
For example: 25.08.19 for 25 August 2019.

The following values can be corrected:

- Daily yield (kWh)
- Daily consumption (kWh)
- Daily self-consumption (kWh)
- Daily self-consumption Battery (kWh)

If consumption or yield values were modified with the data correction option, these corrected values are displayed additionally in the key and in the yield data under the Production | Day and Balances | Day menus.

12.15.3 System backup

The Configuration | Data | Backup menu offers the following functions:

- Restore configuration from hard disk.
- Save configuration to hard disk.
- Save configuration to USB.
- Restore configuration from USB.

The system data consist of all the data that have been saved in the configuration. It is recommended always to make a backup of the system data before changing the configuration or updating the firmware.

Restoring configuration from hard disk section

This function imports the configuration file from the solarlog_config.dat file into the Solar-Log™.

Procedure:

- Click on **Browse**.
- The file manager of your OS appears.
- **Select the DAT file** that is to be imported.
- The selected firmware's file name is displayed.
- Click on **Upload**.
- The configuration is being imported. Please wait a moment.
- The Solar-Log™ reboots itself.

Saving configuration to hard disk section

With the function a configuration file can be created and saved to a hard drive.

A Solar-Log configuration file has the following file name: "solarlog_config.dat."

Procedure:

- Click on **Prepare**.
- After the data has been prepared, the Download option is displayed.
- Click on **Download**.
- Depending on your browser settings, a window pops up with the options to open the file with a program or save file.
- Select **Save file**.
- The file is saved in the download folder.

Alternative procedure:

- Click on [Prepare](#).
- After the data has been prepared, the Download option is displayed.
- Right click with the mouse on [Download](#).
- Select [Save link as](#).
- The file manager of your OS appears.
- Select the desired location to save the file to.
- [Select save](#).
- The file is saved in the selected folder.

Saving configuration to USB section

With this function, a backup can be saved to a USB stick which is directly connected to the device.

Procedure:

- Touch [Save](#).
- The configuration is being created. Please wait a moment.
- The progress and status of the update are displayed.
Finish current measurement.
Select the USB storage device
Save configuration.
- The solarlog_config_YYMMDD.dat file is saved in the /Backup directory of the USB stick.
YYMMDD stands for year, month and day - each two digits, e.g. solarlog_config_180502.dat is then the backup from 02 May 2019.
- The configuration file can be saved elsewhere as a backup or imported into the Solar-Log™ again.

Restoring configuration from USB section

This function imports the solarlog_config.dat (or solarlog_config_YYMMDD.dat) configuration file from a USB stick which is directly connected to the device into the Solar-Log™.

Procedure

- Click on [Restore](#).
- Backup files are searched for on the USB stick that is directly connected to the Solar-Log™
First it looks in the main directory of the USB stick for solarlog_config.dat, then it looks in the /backup directory. And lastly it looks in the backup directory for "solarlog_config_YYMMDD.dat." When it looks for the solarlog_config_YYMMDD.dat. file, it loads the latest file.
- Start this search.
- When a configuration file is found on the USB stick, click on [RESTORE](#) to import it.
This data is being imported.
Please wait.
- The Solar-Log™ reboots itself.
- The configuration file was imported.

12.15.4 Backup

The [Configuration | Data | Backup](#) menu offers the following functions:

- Restore data backup from hard drive.
- Save data backup to hard drive.
- Save data backup to USB
- Restore data backup from USB

Restore data backup from hard drive section

This function restores the backup file with the name solarlog_backup.dat to the Solar-Log™.

Procedure:

- Click on [Upload](#).
- The file manager of your OS appears.
- [Select the DAT file](#) that is to be imported.
- The selected backup's file name is displayed.
- Click on [Upload](#).
The configuration is being imported. Please wait a moment.
- The Solar-Log™ reboots itself.

Saving data backup to hard drive section

With the function a backup can be created and saved to a hard disk.

A Solar-Log backup file has the following file name: "solarlog_backup.dat."

Procedure:

- Click on [Prepare](#).
- The progress and status of the update are displayed.
Finish current measurement.
Select the USB storage device
Save the configuration after the data has been prepared, the Download option is then displayed.
- Click on [Download](#).
- Depending on your browser settings, a window pops up with the options to open the file with a program or save file.
- Select Save file.
- The [file](#) is saved in the download folder.

Alternative procedure:

- Click on [Prepare](#).
- The progress and status of the update are displayed.
Finish current measurement
Select the USB storage device
Save configuration
- After the data has been prepared, the Download option is displayed.
- Right click with the mouse on [Download](#).
- Select Save link as.
- The file manager of your OS appears.
- Select the desired location to save the file to.
- [Select save](#).
- The file is saved in the selected folder.

Saving data backup to USB section

With this function, a backup can be saved /Backup directory of a USB stick which is directly connected to the device.

Procedure:

- Touch [Save](#).
- The backup is being created. Please wait a moment.
- The progress and status of the update are displayed.
 - Finish current measurement
 - Select the USB storage device
 - Save configuration
- The solarlog_backup_YYMMDD.dat file is saved in the /Backup directory of the USB stick. YYMMDD stands for year, month and day - each two digits, e.g. solarlog_backup_190725.dat is then the backup from 25 July 2019.

The Solar-Log™ backup can be copied to another storage medium or imported into the Solar-Log™ again.

Restoring backup from USB section

This function restores a backup file with the name solarlog_backup.dat from the USB stick connected directly to the device to the Solar-Log Base.

Procedure:

- Click on [Restore](#).
- Backup files are searched for on the USB stick that is directly connected to the Solar-Log™
 - First it looks in the main directory of the USB stick for solarlog_backup.dat, then it looks for the same file name in the /backup directory. And lastly it looks in the backup directory for the file solarlog_backup_YYMMDD.dat. When it looks for the solarlog_config_YYMMDD.dat. file, it loads the latest file.
- [Start](#) this search.
- When a configuration file is found on the USB stick, click on [Restore](#) to import it.
- The backup is being restored. Please wait a moment.
- The Solar-Log™ reboots itself.
- The configuration file was imported.

12.15.5 Reset

The **Configuration | Data | Reset** menu offers the following functions:

- Reset the yield data.
- Reset the inverter configuration.
- Restore factory settings.

Resetting yield data section

In certain circumstances after an inverter detection, it may occur that incorrect or unusable data is displayed. In this case, the stored data can be deleted without having to reconfigure the Solar-Log™ completely.

Procedure:

- Click on **RESET**.
- If you are sure that the data should be deleted, click on **Continue**. Otherwise click on **Cancel**.
- The data is being deleted.
- The Solar-Log™ reboots itself.

Resetting inverter configuration section

If the Device Detection needs to be started again, it is recommended to delete the previous inverter configuration with this function.

Procedure:

- Click on **RESET**.
- If you are sure that the inverter configuration should be deleted, click on **Continue**. Otherwise click on **Cancel**.
- The data and inverter configuration are deleted.
- The Solar-Log™ reboots itself.

Restore factory settings section

This function restores the Solar-Log™ to its factory settings. All of the yield data and configuration is deleted.

Procedure:

- Click on **RESET**.
- If you are sure that the data should be deleted, click on **Continue**. Otherwise click on **Cancel**.
- The factory settings are being restored.
- The Solar-Log™ reboots itself.

Note



The network settings remain when this function is used.

12.16 System Configuration

The [Configuration | System](#) menu has the basic settings for the Solar-Log™ and contains the following tabs:

- Access control
- HTTPS
- Language/Country/Time
- Licenses
- Firmware

12.16.1 Access control

Browser access protection for the Solar-Log™ can be configured in this menu. The following parts of the Solar-Log™'s browser menu can be restricted with a password:

- User:
General access to the [browser menu](#).
- Installer:
Access to the [Configuration](#) menu.
- Feed-in management:
Access to the [Configuration | Feed-in Management](#) menu.

The default password for access to the Feed-in Management menu is PM. Access for users and installers is not restricted.

Note



We advise installers to discuss with their customers the scope of the settings in the area of feed-in management, to block the configuration menu using a password and to assign an individual password.

Procedure:

- **Activate** the [password restriction](#) for the desired menus.
- **Enter** a secure password for each of the menus.
- Enter the password again.
- **SAVE** the settings.

12.16.2 HTTPS

The following sections are located here:

- SSL certificate
- User-specific certificate

SSL certificate

An SSL certificate is a code on the web server that secures online communication. When a web browser connects to a website, the SSL certificate provides a secure connection.

The Solar-Log™ uses such an SSL certificate. This can be imported into the web browser or the operating system.

There is also the option to use your own SSL certificate instead of the Solar-Log™ certificate.

There are four different boxes under SSL certificate:

- Status:
This indicates which certificate the Solar-Log™ is currently using.
- SSL certificate fingerprint:
The correctness and authenticity of the certificate used can be verified by means of the fingerprint. This is done by comparing the string displayed in the field with the reference sequence in the browser.
- Issue a new certificate:
You can use the button issue a new certificate, but the certificate currently used will be irrevocably deleted.
- Download SSL certificate:
The Download button offers the option to download the SSL certificate and to import it into the browser or operating system.

User-specific certificate

An user-specific certificate can be uploaded in this section. Go to "Browse" to select the certificate you want to upload.

Note



Please note the help texts in the individual sections.

12.16.3 Language/Country/Time

The following options are available from the [Configuration | System | Language/Country/Time](#) menu:

- System language of the Solar-Log™.
- Country/Location of the Solar-Log™.
- System time of the Solar-Log™.
- Time synchronization.

Language section

Procedure:

- Select the desired [Language](#) in the selection menu.
The selected display language applies both to the display and the web browser.
- [SAVE](#) the settings.

Country section

Procedure:

- Select your [Country](#) in the selection menu.
The country setting affects how the date, time and currency formats are displayed.
- [SAVE](#) the settings.

Time section

Solar-Log™ has an integrated real-time clock which can maintain the clock time even in the case of a power failure or grid disconnection, and for a long period (50 days).

The clock time is factory-set, but it may be lost due to long periods of storage.

The time zone, date and summertime values must be set correctly, so that no incorrect statuses or results are obtained during monitoring and graph display, e.g. when e-mail messages are sent or when a curve is displayed on the day graph.

Time	
Date / Time (currently)	28.08.19 14:44:04
Date / Time (new)	<input type="text"/>
	<input type="button" value="SET"/>
Timezone GMT	+1:00
Day Light Saving Time settings	CEST (Central European S) ▾

Fig.: Configuring the time on the Solar-Log™

Adjust the time in the [Configuration | System | Language/Country/Time](#) menu.

Adjust the new system time

Procedure:

- The current system time is displayed.
- Enter the following format to change [the date and time](#):
DD/MM/YY HH:MM:SS
For example: 28.08.19 14:44:04 for 28 August 2019 14 Hours 44 Minutes 04 seconds
- [SET](#) a new date and time.

Adjust the time zone

Procedure:

- Enter the time difference in hours (time zone).
Default: GMT +1.
- Save the entry .

Set Day Light Saving Time.

Procedure:

- Select the corresponding Day Light Saving Time settings:
Options: no, CEST (Central European Summer Time), USA, Australia.
- SAVE settings.

Automatic time synchronization section

To automatically synchronize the system time, the Solar-Log™ regularly contacts a network time protocol (NTP) server.

If the Solar-Log™ is connected to the internet via a router, the synchronization occurs during the night.

Procedure:

- Activate the Automatic time synchronization button.
- SAVE the settings.

Update now function, the time synchronization with the NTP server can be manually started. The NTP port 123 needs to be enabled in the gateway or firewall.

12.16.4 Licenses

Certain Solar-Log™ functions have to be activated by entering a license code. You receive a license certificate after purchasing a license for a particular function. The licenses are always linked to the serial number of the particular Solar-log™ and can only be used with the device with this serial number.

Perform the following steps to purchase a license:

- Go to the license portal at <https://license.solar-log.com>
- Log on with your Enerest account.
- After you have enter the serial number of the Solar-Log™, a list of compatible licenses is displayed.
- You can only select one license from the list. After the selection has been made, the web-shop payment options appear.
- After the payment confirmation, the license is valid.

Automatic import:

- Go to the Configuration | System | Licenses WEB menu of the Solar-Log™.
- Click on Synchronize.
- Now the Solar-Log™ connects to the license server and downloads all of the active licenses.

Manual import:

- Download the license file from the License portal.
- Go to the Configuration | System | Licenses WEB menu of the Solar-Log™.
- Click on the plus symbol and select the license file.

After importing the license, it is activated immediately and "Installed" is displayed.

Note



Licenses are linked to the device (serial number). The license has to be purchased again if a device has been replaced after the warranty has expired.

Note



If a Solar-Log™ with a license has a defect during the warranty period, a license can be requested for the replacement device. There are no costs involved, provided that the defective device is returned to Solare Datensysteme GmbH.

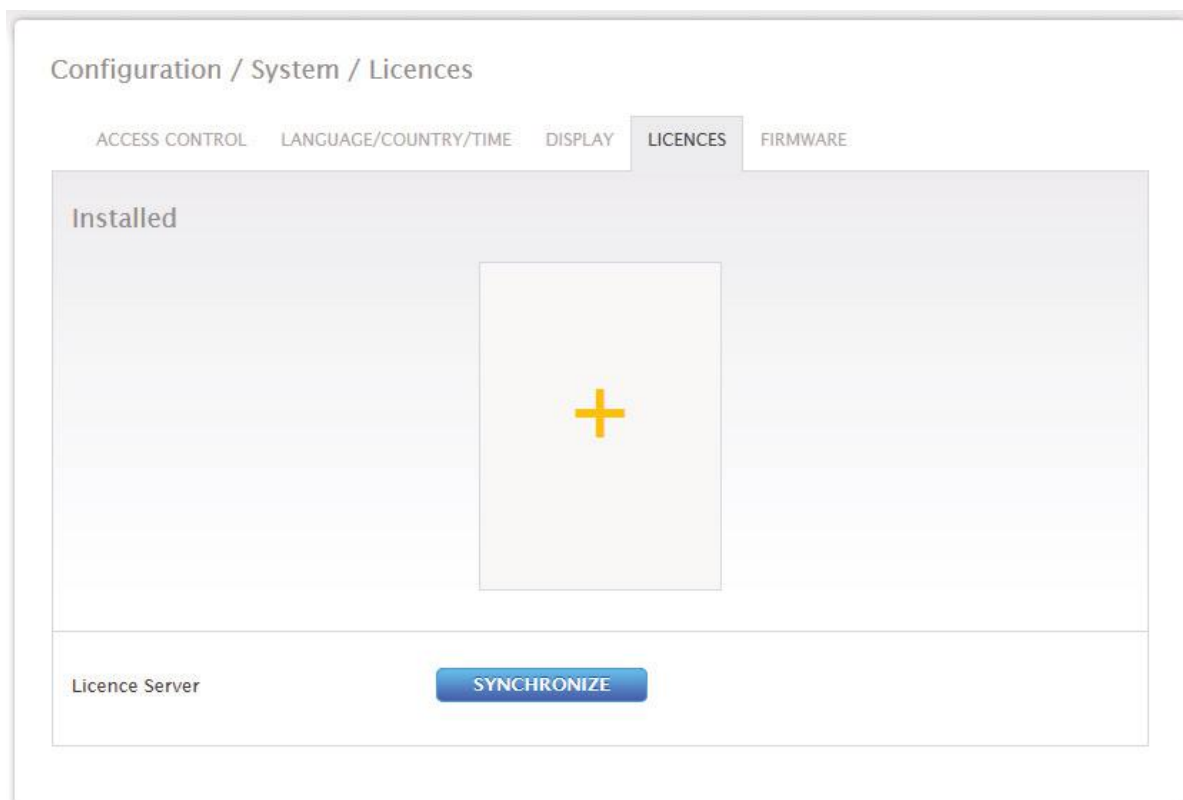

Fig.: Solar-Log™ with license section

12.16.5 Firmware

The firmware tab offers the following functions:

- Information about the current firmware version.
- Firmware update options.

Status section

The firmware version currently installed on the Solar-Log™ is displayed. The version number contains three sections:

Version number	Build	Date
5..0.1	Build 151 -	26.08.2019

Updating firmware manually section

This function allows a new firmware to be imported from a disk.

Note



Before manual updating, it is important to save the current system data and make a backup.

Note



Clear the browser's cache after updating the firmware to prevent any possible display errors.

Procedure:

- Click on **Browse**.
- The file manager of your OS appears.
- Select the firmware file that is to be imported.
- The selected firmware's **file name** is displayed.
- Click on **Upload**.
- Then you are asked if system and data backups have been made. If you click "Cancel" on these queries, the process is aborted.
- The progress and status of the update are displayed.
 - Upload the file
 - Finish current measurement.
 - Restart.
 - Unzip the file.
 - Restart.
- The Solar-Log™ reboots itself.
- The **Current Firmware Version** is shown in the display and in this menu.

Check for Update from the Internet section

With this function, the Solar-Log™ contacts the Solare Datensysteme GmbH firmware servers to check if a new version is available and offers to install it.

Check for Update from USB

With this function, the Solar-Log™ checks the USB stick connected directly to the device if a new version is available.

When this function is used, the progress and status of the update are displayed:

- Select current measurement and
- the USB storage device.

Automatic Firmware Updates

This function constantly checks if there is a new firmware version for the Solar-Log™. When there is a newer version, it is automatically downloaded and installed during the night.

Note



By activating this function, you give Solare Datensysteme GmbH permission to automatically load minor updates. This function is not intended to replace manual firmware updates.

13 Diagnostics Menu

Click on Diagnostics in the tool bar to access the Diagnostics menu.

The following options can be selected from the [left-side navigation](#) menu:

- Inverter Diagnostic.
- Event log.
- Feed-In Management chapter of the Installation Manual.
- SCB Monitor (only when SCB active).
- CSV Export.

13.1 Inverter Diagnostic

To access the Inverter diagnostic menu, go to [Diagnostic | Inverter Diagnostic](#).

The following tabs can be selected from this menu:

- Inverter details,
- Tracker comparison and
- Module field comparison.

Different values with different units are displayed in the following diagnostic graph. A key is displayed for every graphic to define which units are used and their colors.

13.1.1 Inverter details

To access the Inverter details menu, go to [Diagnostic | Inverter Diagnostic | Inverter details](#).

A particular date and device (e.g. inverter or sensor) can be selected under inverter details and evaluated.

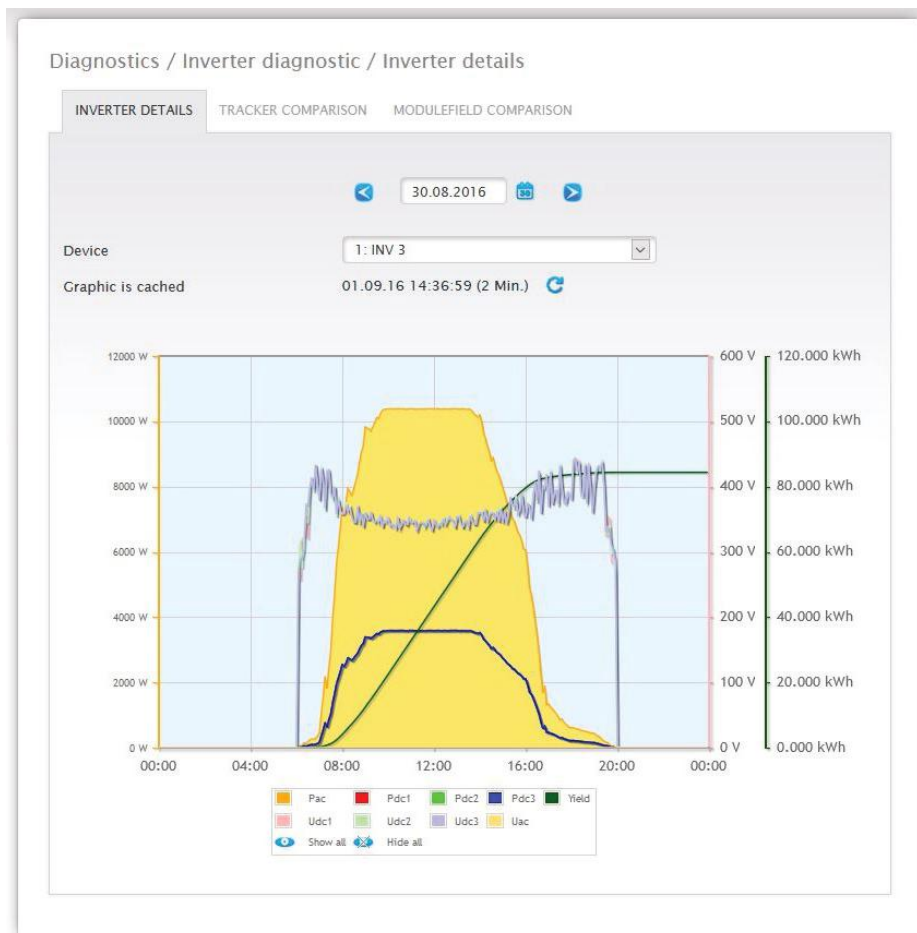

Fig.: Inverter details graph

In the example (see Fig.: Inverter details graph), the following values for the inverter can be displayed:

- Pac
- DC power 1
- DC power 2
- DC power 3
- Yield
- DC voltage 1
- DC voltage 2
- DC voltage 3
- AC voltage (Uac) – this value is displayed if the inverter supports this function).

All of the values displayed in the key can be selected and deselected at anytime with a left-click to display individual values (curve) or to display or hide all values (curves). With a right-click, all of the values (curves) other than the one selected can be hidden.

13.1.2 Tracker comparison

To access the Tracker comparison menu, go to [Diagnostic | Inverter Diagnostic | Tracker comparison](#). Two trackers (either from the same device or two different devices) can be compared on a particular date by selecting the date, device and tracker.

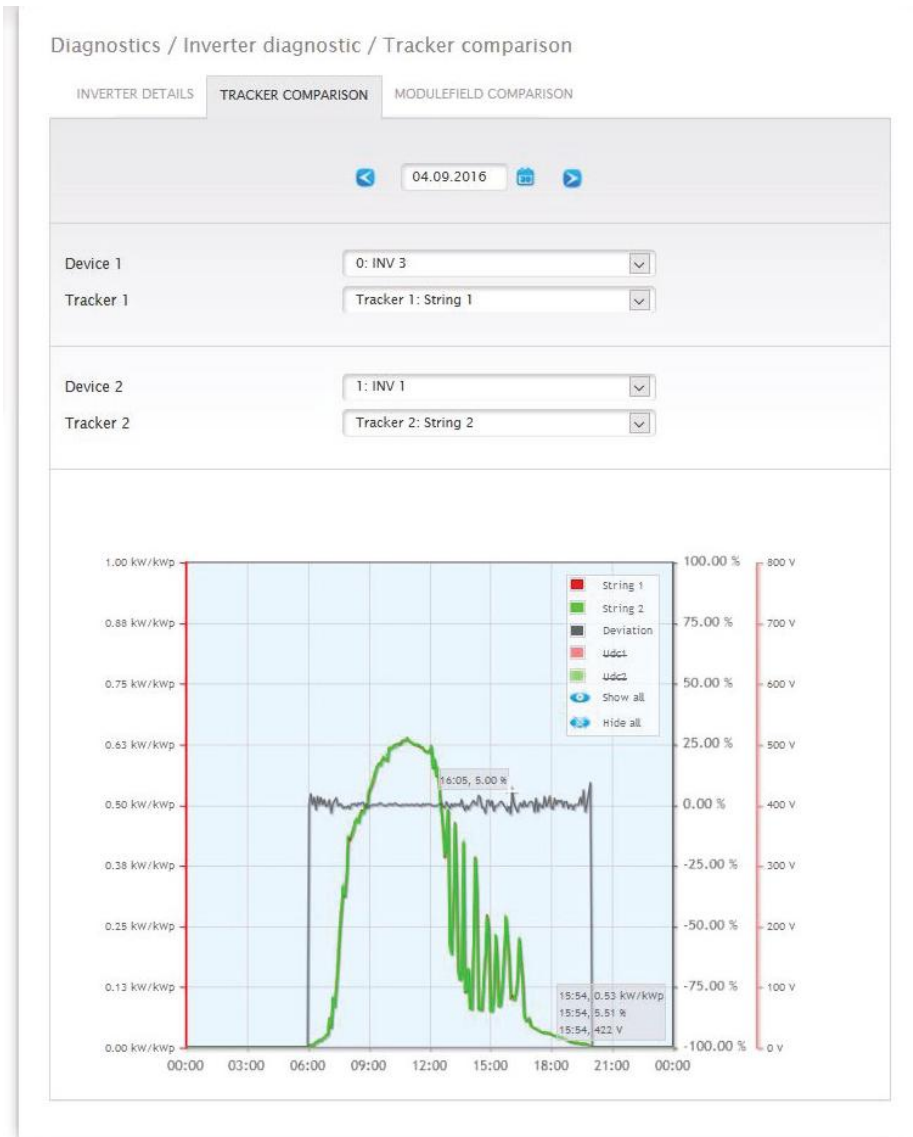

Fig.: Tracker comparison graph

In the example (see Fig.: Tracker comparison graph), two different inverters have been selected and evaluated. The better view has been selected for the DC voltage 1 and 2 values.

The two strings from inverter 3 and 1 are directly compared to each other.

The gray line displays the degree of deviation. The deviation as a percentage is indicated in the right column, and displayed as a positive or negative percentage. In the example, the deviation between the strings is from about -5% to +5%. The column on the left indicates the kW/kWp output of the tracker. All of the values displayed in the key can be selected and deselected at anytime with a left-click to display individual values (curve) or to display or hide all values (curves). With a right-click, all of the values (curves) other than the one selected can be hidden.

13.1.3 Module field comparison

To access the Module field comparison menu, go to [Diagnostic | Inverter Diagnostic | Module field comparison](#).



Fig.: Module field comparison graph

With the [Date and Module Field](#) boxes, the module field comparison permits all devices (e.g. inverters and sensors) and their strings that are assigned to the same module field to be compared on the current and previous days (see Fig.: Module field comparison graph) in order to more efficiently detect faults from the performance monitoring.

In the example graph, the following values are displayed:

- Sensorbox (S 4).
- INV 1; INV 2.

All of the values displayed in the key can be selected and deselected at anytime with a left-click to display individual values (curve) or to display or hide all values (curves). With a right-click, all of the values (curves) other than the one selected can be hidden.

Note



Only a maximum of 50 curves can be displayed.

13.2 Battery Diagnostic

To access the Battery diagnostic menu, go to [Diagnostic | Battery Diagnostic](#).

The following tabs can be selected from this menu:

- Current Measurement Values
- Charging History 1-Day.
- Charging History 7-Days.
- Balances.

13.2.1 Current Measurement Values

The following values are available from the [Current Measurement Values](#) tab:

- Battery voltage (V):
The current voltage of the battery.
- Charge Level (%):
The current charge status of the battery as percentage.
(The charge level for power meters in battery meter mode is currently not set.)
- Current charging power (W):
The battery's current amount of charge in watts.
- Current power output (W):
The discharge output in watts.

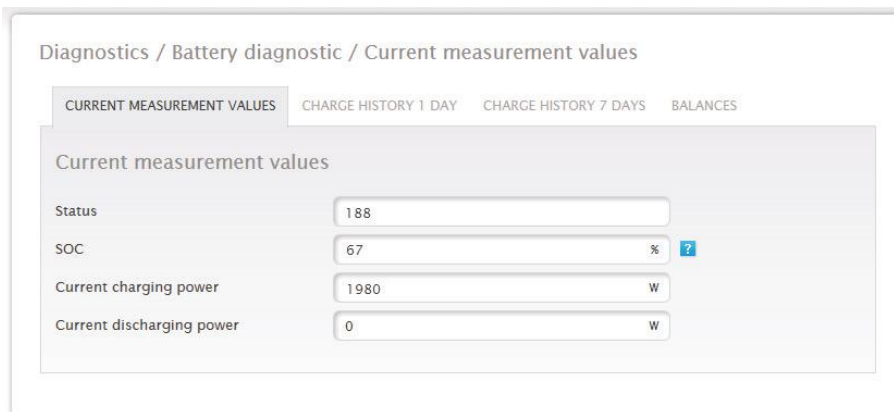

Fig.: Battery diagnosis - Current measurement values

13.2.2 Charging History 1-Day

A daily graph with the following values is in the [Charging History 1-Day](#) tab.

- Charge:
The battery's charge levels throughout the day in watts.
- Discharge:
The battery's discharge levels throughout the day in watts.
- Charge Level (%):
The battery's charge levels throughout the day as a percentage.
- U (V):
The battery's voltage curve throughout the day in volts.



Fig.: Battery diagnosis - Charging History 1-Day

The [Date](#) box offers the option to select a particular day for viewing. The arrow keys can also be used to move to the next or previous date.

The individual values, at the top-left of the graph key, can be displayed or hidden with a mouse click.

13.2.3 Charging History 7-Days

A graph containing the last seven days with the following values is in the [Charging History 7-Days](#) tab.

- Charge:
The battery's charge levels from the last 7 days in watts.
- Discharge:
The battery's discharge levels from the last 7 days in watts.
- Charge Level (%):
The battery's charge levels from the last 7 days as a percentage.
- U (V):
The battery's voltage curve over the last 7 days.



Fig.: Battery diagnostic - Charging History 7-Days

The [Date](#) box offers the option to select a particular 7-day period for viewing. The arrow keys can also be used to move to the next or previous date.

The individual values, at the top-left of the graph key, can be displayed or hidden with a mouse click.

If needed, click on the [interrupt](#) button to stop loading the data.

13.2.4 Balances

The following sections are in the **Balances** tab:

- Electricity savings from battery usage.
- Battery efficiency.

Electricity savings from battery usage section

The following columns are in this section:

- Discharge:
The battery's discharge during its entire run-time in kWh.
- Electricity costs saved:
The electricity savings from battery usage during its entire run-time in the defined currency.

Battery efficiency section

The following columns are in this section:

- Charge:
The battery's charge during its entire run-time in kWh.
- Discharge:
The battery's discharge during its entire run-time in kWh.
- Efficiency values:
The battery's efficiency values during its entire run-time as a percentage.

Diagnosis / Battery diagnosis / Balances

CURRENT MEASUREMENT VALUES CHARGE HISTORY 1 DAY CHARGE HISTORY 7 DAYS **BALANCES**

Power saving from battery usage	
Discharge	100.439 kWh
Electricity costs saved	30.68 €

Battery efficiency	
Charge	178.230 kWh
Discharge	100.439 kWh
Efficiency value	56.35 %

Fig.: Battery diagnosis - Balance

13.3 Accessing Event logs

To access the Event logs menu, go to Diagnostic | Event logs.
 The following mode is loaded when accessing the event logs.

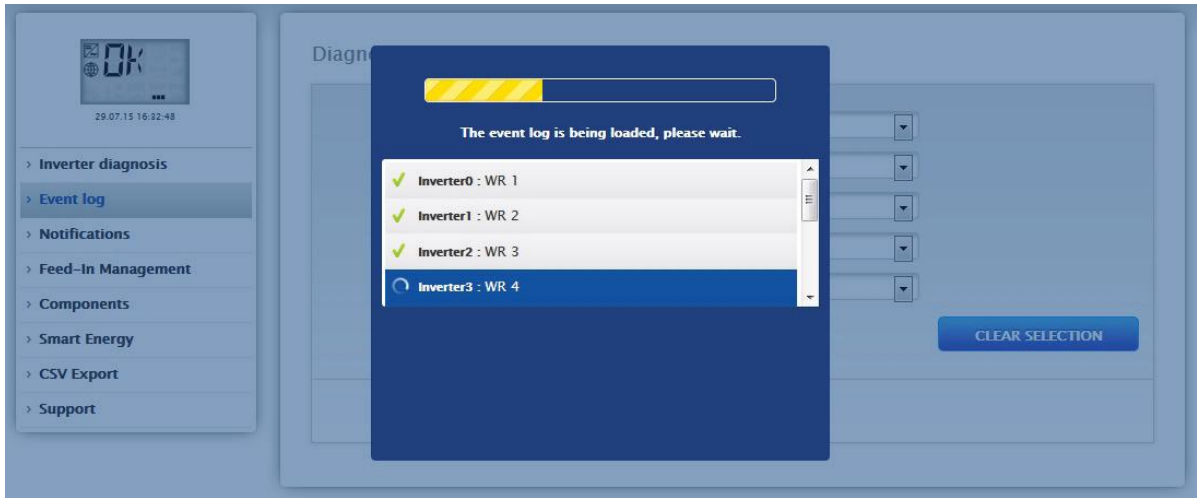

Fig.: The event log is being loaded.

After the event log has been loaded, the window switches back to the normal view.

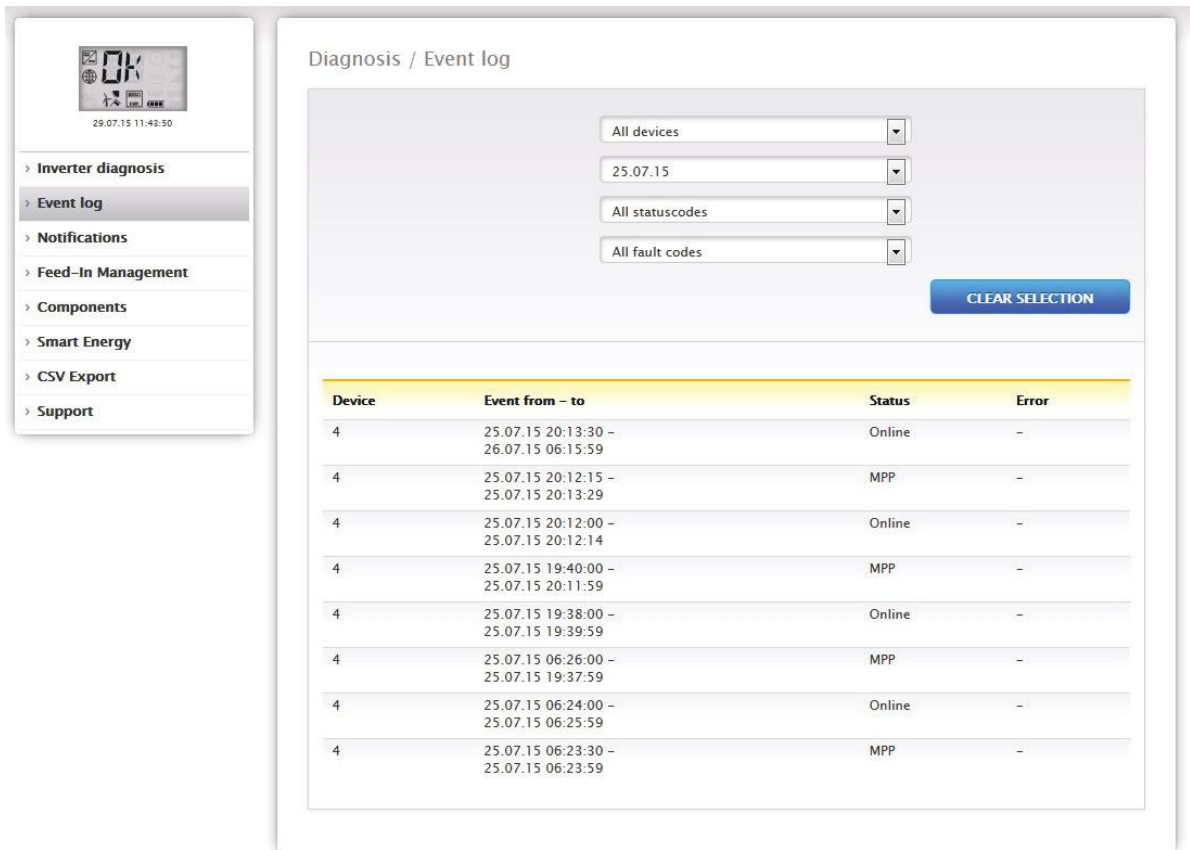

Fig.: Event log

The following settings are available from the four drop-down menus in this view:

- Devices:

Under devices, you can select individual devices or leave the default selection as is (default "All devices").

- Days:

Under days, you can select individual days or leave the default selection as is (default "All days").

- Status codes:

Under status codes, you can select individual status codes or leave the default selection as is (default "All status codes").

- Fault codes:

Under fault codes, you can select individual fault codes or leave the default selection as is (default "All fault codes"). By default, the current day is displayed in the table with all devices, fault codes and status codes.

13.4 Accessing Feed-In Management

To access the Feed-In Management menu, go to Diagnostic | Feed-In Management.

Note!



The menu Feed-In Management under Diagnostic | Feed-In Management only appears if active power has been configured in the Configuration | Feed-In Management section.

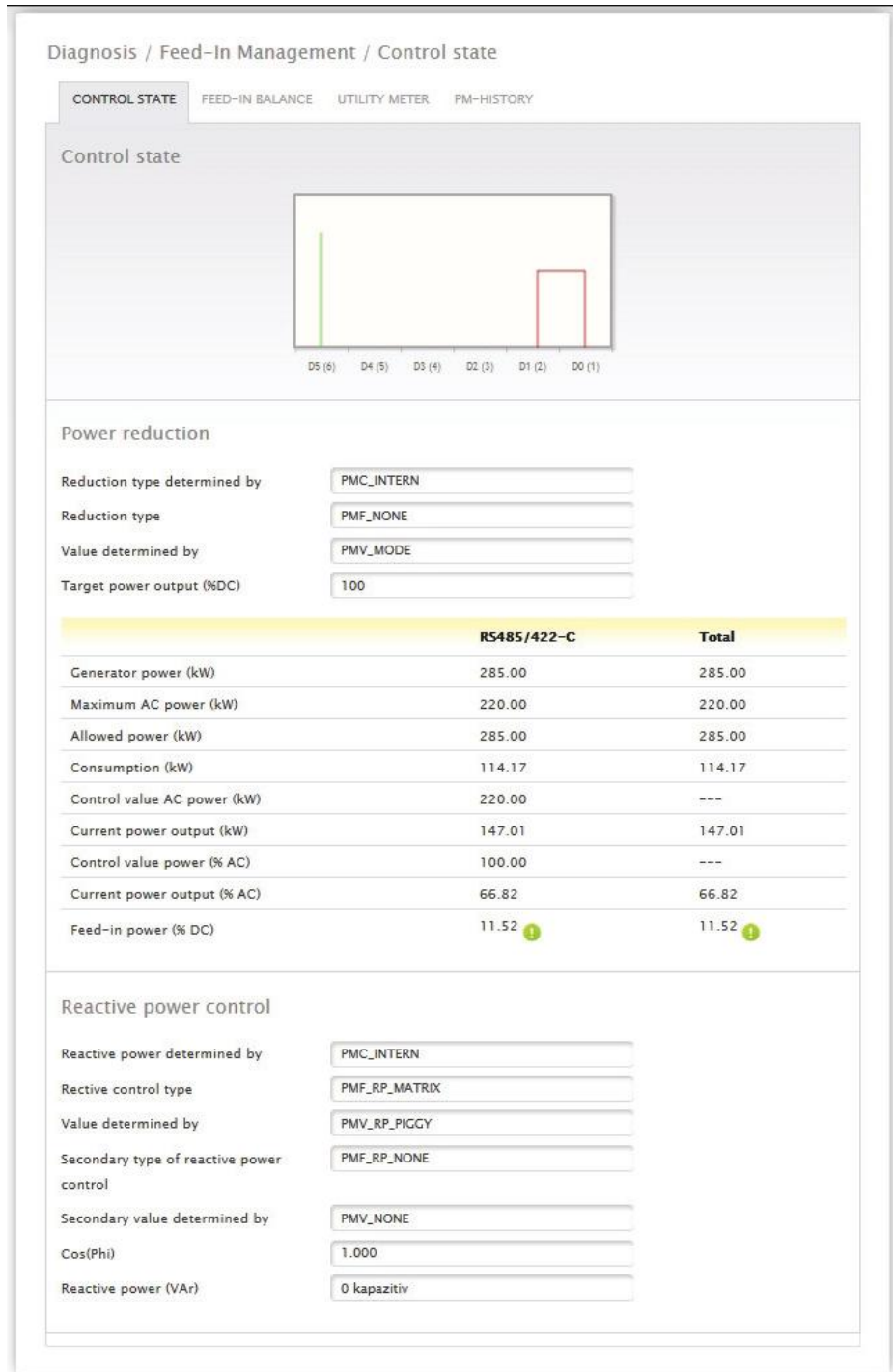

Fig.: Feed-In Management - Control State

The inverter control can be analyzed and adjusted in the [Diagnostic | Feed-In Management](#) settings section.

There is also a [10% Diagnosis Function](#) to simulate a dynamic reduction to 10%.

The values are displayed in the table.

Note!



The 10% Diagnosis Function can only be used when the 70% Fixed Reduction has been activated.

13.4.1 Explanation of the Values in the Power Reduction Section

The following values are displayed in the Power Reduction section:

Power reduction type determined by:

The currently active control source is indicated in this field.

Displayed Text	Explanation Text
PMC_NONE	No control source.
PMC_DIAG	Controlled by the diagnostic mode.
PMC_MODBUS_2	Controlled by the ModBus PM V2 (new ModBusPM).
PMC_MODBUS_1	Controlled by the ModBus PM V1 (old ModBusPM).
PMC_PROFILE	Controlled by the PM Profile.
PMC_INTERN	Controlled by the internal configuration.
PMC_DM_MODBUS	Controlled by direct seller via ModBusDM.
PMC_DM_RCR	Controlled by direct seller via ripple control receiver

Type of Reduction:

This contains the current type of power reduction that is specified by the control source.

Displayed Text	Explanation Text
PMF_NONE	No power reduction function.
PMF_PR_ERROR	An error occurred while determining the power reduction function.
PMF_PR_FIX_PERC	Fixed reduction at % DC.
PMF_PR_FIX_KW	Fixed reduction at X kW (AC)
PMF_PR_VAR_PERC	Fixed reduction at % DC with self-consumption calculation.
PMF_PR_VAR_KW	Fixed reduction at X kW (AC) with self-consumption calculation.
PMF_PR_FIX_MATRIX	Reduction based on the value from the matrix (ripple control receiver configuration).
PMF_PR_VAR_MATRIX	Reduction based on the value from the matrix (ripple control receiver configuration) with self-consumption calculation.

Value specification from:

This field indicates how the control value used was determined.

Displayed Text	Explanation Text
PMV_NONE	No control source.
PMV_CONFIG	The value is stored in the configuration.
PMV_MODE	The value can be determined by the reduction mode.
PMV_PR_PIGGY	The value comes from the PM (power reduction) input (and is determined in combination with the matrix in the configuration or PM profile).
PMV_MPR_PIGGY	The value comes from the PM (power reduction) input of the master (and is determined in combination with the matrix in the configuration or PM profile).
PMV_MODBUS_1	The value comes from the ModBus PM V1 interface.
PMV_MODBUS_2	The value comes from the ModBus PM V2 interface.
PMV_PROFILE_ADAM	The value comes from the analog or digital input of the IO Box (Adam Box).
PMV_PROFILE_INTERN	The value is specified in the PM profile.
PMV_ERROR	An error occurred while determining the value.
PMV_CONFIG_UTILITY	The value was determined via the internal configuration based the Utility Meter measurement.
PMV_MODBUS_DM	The value comes from the ModBus DM interface (direct seller interface).

Target power output %:

The fields indicates the percentage of the Plant's DC power determined by the control for the target output. The detailed values for the individual bus connections and for the total plant are displayed in the following table below. The individual buses (RS485 A-C) are displayed depending on which bus is assigned to control the inverters.

The column **Total** always corresponds to the plant total and reflects the value from the grid connection point. The consumption values are displayed in all of the columns, but only the plant total is taken into account.

Note!

The values from the individual inverters are calculated per bus and for the entire plant.

Generator power (kW):

The generator power corresponds to the module output of the inverter that is connected to this data bus. This value results from the total of the partial outputs entered in the field generator power under configuration | Devices | Configuration. This kW values is used when calculating the output reduction (e.g.: the 70% reduction).

Maximum AC power (kW):

The maximum AC power of the inverter(s) depends on the device. Refer to the inverter specifications for this value and configure it in the field Maximum AC power under configuration | Devices | Configuration.

Allowed power (kW):

This kW value is the maximum amount of power that is allowed at the grid connection point. The value is calculated based on the generator output and the current power output.

Consumption (kW):

This value is calculated from the consumption meters and refers to the entire plant. The values displayed in the respective bus column only refer to the plant total and are not taken into account in the corresponding columns. The consumption value is normally subtracted from the allowed power from the entire plant.

Control value power (kW):

This value is calculated by the Solar-Log™ and is the maximum current power output from the inverters. It is used for the current target power output.

Note!

Due to technical reasons, the calculation from the Solar-Log™ is subject to a rounding factor. This may lead to deviations in the data recording.

Current power output (kW):

The value refers to the current output generated by the inverter per interface (column) and for the entire plant.

Control value power (% AC):

The Solar-Log™ calculates the control value power (kW) as a percentage of the maximum AC power and relays this to the inverters.

Current power output (AC%):

The value indicates the total output generated as a percentage of the maximum AC power for the inverter or all of the inverters on a bus.

Feed-in power (% DC):

This value is the current amount of feed-in power as a percentage of the generated output.

13.4.2 Explanation of the Symbols in the Feed-in power (% DC) column:



The feed-in power value is in the target power range with a tolerance of -2% to +1%.



The feed-in power value is below the target value allowed. Generally, this means that the output allowed at the grid connection point is not being achieved due to low irradiation or high self-consumption.



This means that the value is above the target value allowed.

If the red triangle is only displayed at a bus and entire plant has a green symbol, this means that only this bus is over the target value allowed. However, the plant totals do not go over the target value because of self-consumption.

13.4.3 Explanation of the Values in the Reactive Power Reduction Section

The following values are displayed in the Reactive Power Reduction section:

Reactive Power determined by:

The currently active control source is indicated in this field.

Displayed Text	Explanation Text
PMC_NONE	No control source.
PMC_DIAG	Controlled by the diagnostic mode.
PMC_MASTER	Controlled by Master Solar-Log™
PMC_MODBUS_2	Controlled by the ModBus PM V2 (new ModBusPM).
PMC_MODBUS_1	Controlled by the ModBus PM V1 (old ModBusPM).
PMC_PROFILE	Controlled by the PM Profile.
PMC_INTERN	Controlled by the internal configuration.
PMC_DM_MODBUS	Controlled by direct seller via ModBusDM.
PMC_DM_RCR	Controlled by direct seller via ripple control receiver

Type of Reactive Power Reduction:

This contains the type of reactive power reduction that is specified by the active control source.

Displayed Text	Explanation Text
PMF_RP_NONE	No reactive power control.
PMF_RP_ERROR	An error occurred while determining the reactive power control function.
PMF_RP_FIX_COS	Fixed Cos(Phi) specification.
PMF_RP_FIX_Q	Fixed reactive power specification.
PMF_RP_Q_U_LINE	Reactive power determined by the characteristic curve Q(V)
PMF_RP_P_PN_LINE	Cos(Phi) determined by the configured characteristic curve P/Pn
PMF_RP_ADJUSTABLE	The control function is determined by an input (e.g. via a ripple control receiver or IO Box/Profile).
PMF_RP_MATRIX	The Cos(Phi) specifications are determined by the the configured matrix.

Value specification from:

This field indications how the control value used was determined.

Displayed Text	Explanation Text
PMV_NONE	No control source.
PMV_CONFIG	The value is stored in the configuration.
PMV_MODE	The value can be determined by the reduction mode.
PMV_RP_PIGGY	The value comes from the PM (reactive power control) input (and is determined in combination with the matrix in the configuration or PM profile).
PMV_MRP_PIGGY	The value comes from the PM (reactive power control) input of the master (and is determined in combination with the matrix in the configuration or PM profile).
PMV_MODBUS_1	The value comes from the ModBus PM V1 interface.
PMV_MODBUS_2	The value comes from the ModBus PM V2 interface.
PMV_PROFILE_ADAM	The value comes from the analog or digital input of the IO Box (Adam Box).
PMV_PROFILE_INTERN	The value is specified in the PM profile.
PMV_ERROR	An error occurred while determining the value.
PMV_CONFIG_UTILITY	The value was determined via the internal configuration based the Utility Meter measurement.
PMV_MODBUS_DM	The value comes from the ModBus DM interface (direct seller interface).
PMV_MASTER	The value can be determined by the Master Solar-Log™.

Secondary Type of Reactive Power Control:

If "PMF_RP_ADJUSTABLE" is entered as the "Type of Reactive Power Reduction," the variable assignment from the selected type of reactive power control is indicated in this field.

For example, a PM profile defines that the type of reactive power control is determined by the Adam Box.

That means:

The profile is responsible for the control. It is set up in the profile that the control can be selected via the Adam Box.

The type of control selected is displayed under "Secondary Type of Reactive Power Control."

The possible values are identical to those for "Type of Reactive Power Control."

Secondary value specification from:

When a secondary control is used, the source of the control value is indicated in this field. The possible values are identical to those for "Value specification from."

Cos(Phi):

The value defined in the [Configuration | Feed-In Management | Reactive Power Control](#) is displayed in this field.

Reactive power (Var):

The value defined in the [Configuration | Feed-In Management | Reactive Power Control](#) is displayed in this field.

13.4.4 Feed-balance section

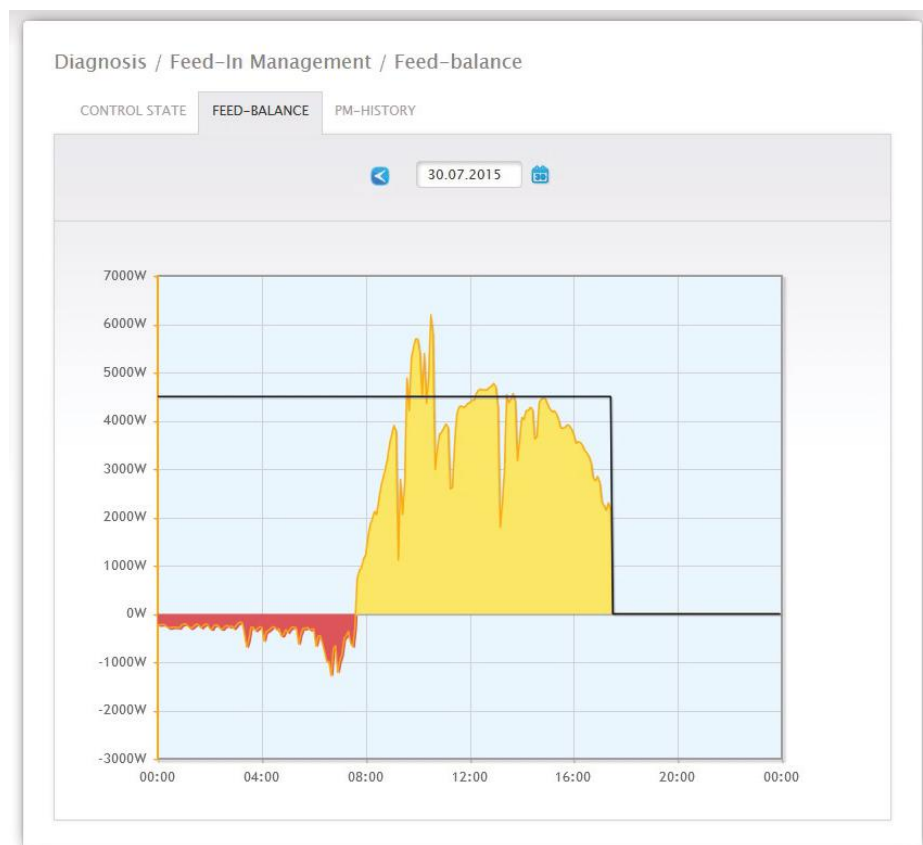

Fig.: Feed-In Management - Feed-balance

The **Feed-balance** tab displays when there was a grid feed and when electricity was purchased from the grid. Negative values mean that the power was purchased from the grid and positive values mean that power was fed into the grid.

Move the mouse cursor over the black line to display the following values for the power reductions:

- Time
- Percentage (%DC)
- Watt

13.4.5 PM History section

The power reductions are displayed in a table with three columns in the **PM History** tab.

Event from - to	Power reduction	Reduction type determined by
08.07.15 10:05:54 - 08.07.15 16:19:29	100%	PMC_INTERN
08.07.15 16:19:30 - 29.07.15 14:32:13	0%	PMC_INTERN
29.07.15 14:32:14 - 29.07.15 14:32:44	100%	PMC_INTERN
29.07.15 14:32:45 - 29.07.15 14:43:57	0%	PMC_INTERN
29.07.15 14:43:58 - 29.07.15 16:10:29	100%	PMC_INTERN
29.07.15 16:10:30 -	60%	PMC_INTERN

Fig.: PM History

- Event from - to:
 - The time and date that a power reduction was activated.
- Power reduction type determined by:

Possible values in this column:

 - PMC_NONE
 - PMC_DIAG
 - PMC_MODBUS_2
 - PMC_MODBUS_1
 - PMC_PROFILE
 - PMC_INTERN
 - PMC_DIRECTM

(For an explanation, refer to the section: "Explanation of the Values in the Power Reduction " in the table "Power reduction type determined by").
- Power reduction:
 - The power reduction as a percentage.

Two additional tabs can be accessed in the Feed-In Management menu (as long as the devices are connected):

- Utility Meter
- I/O Box

Detailed instructions in the Chapter [Configuration - Feed-in Management](#) below.

13.5 Accessing components

To access the Components menu, go to [Diagnostic | Components](#).

The following tabs are available in the Components menu:

- RS485 Bus Analysis
- SO Meter (only visible when SO meter is connected)
- Wireless Package (only visible when the Wireless package is connected and has been activated)
- SCM Monitor (only visible when connected and the SCB license has been activated)

13.5.1 RS485 Bus Analysis

The RS485 bus analysis checks the RS485 bus communication and the associated value transmission. The interface, device and level have to be selected to perform an analysis. The higher the level, the more details that are in the results. However, it takes more memory and takes longer to process. When the settings are defined, the analysis can be performed by clicking on "Start Analysis." (see illustration)



Fig.: RS485 bus analysis with Janitza as an example (with installation mode active)

Once the analysis has been started, an inquiry is sent to the selected device. At the same time, the Solar-Log™ performs the bus analysis. The results (inquiry and response) can be viewed in the dialog (see previous illustration).

The view of the measured values can be enlarged and displayed in more detail using the mouse (either by holding down the right mouse button and dragging the cursor or using the mouse wheel). In the second part, you can also see which section of the measured value range you are currently in. Use the mouse cursor to control the section of the measured value range via the lower section. The measured values for RS485A-A or RS485A-B can also be displayed or hidden. (Refer to the illustrations below.)

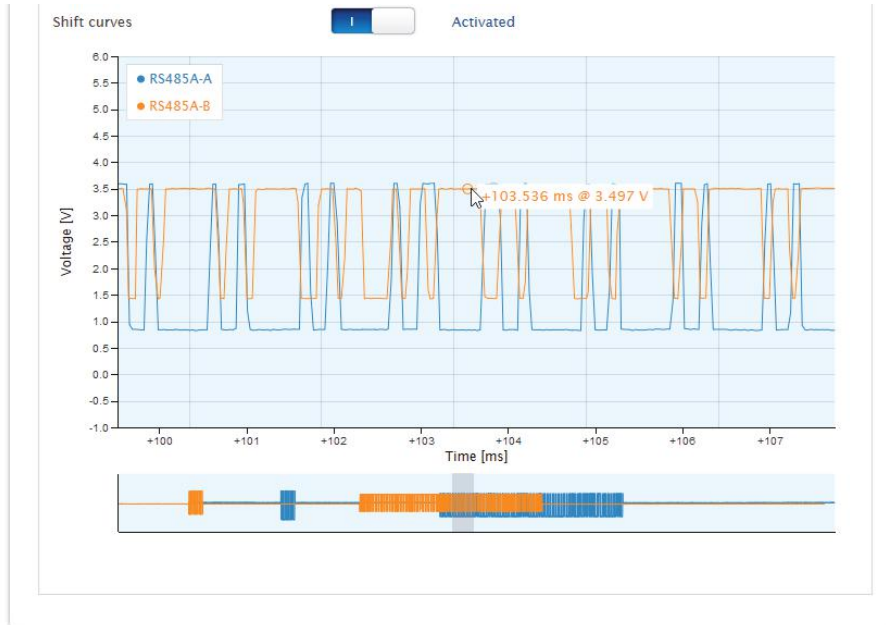

Fig.: Example segment section of the enlarged measured value range

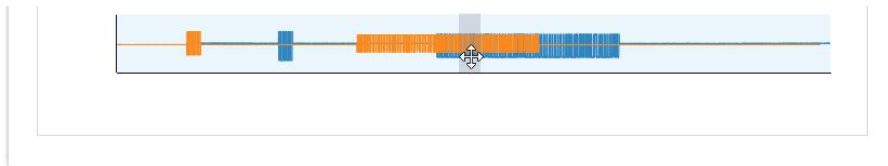

Fig.: Example segment section of the lower measured value range

Note!



Important for the analysis:

Due to technical reasons, the RS485A-A and RS485A-B channels are recorded with a time delay during the analysis. That is why it is normal to have a time delay for both curves. If the "Shift curves" check box is activated, the system corrects this time offset automatically.

13.5.2 SO Meter (only visible when connected)

All of the SO meters connected to the Solar-Log™ are listed in the [Diagnostic | Components | SO-Meter](#) menu.

The following values are displayed in the Pulse meter box:

- Total number of pulses for the SO meter since the last restart of the Solar-Log™ (first number)
- Number of pulses since the menu has been accessed (second number)
- Pulse number interval in a minute (third number)



Fig.: Components - SO meter on interface A and B

Note!



The Solar-Log™ reorganizes the data every night so the total pulse counter of the SO meter is reset every night.

13.5.3 Wireless Package (only visible when activated)

You can access the Wireless Package test function from the [Diagnosis | Components | Wireless Package](#).



Fig.: Connection test - Wireless Package

To perform a connection test a Wireless Package has to be connected to the Solar-Log™, the interface with the Wireless Package has to be activated in the [Configuration | Devices | Definition](#) menu and the inverter has to be selected. Select the interface that the Wireless Package is connected to and press the Start button for the connection test.

The test is successful when the line goes to 100% percent and remains there.

Note!



Successful data transfers can only be guaranteed when the wireless connection is consistently at 100%.

13.6 Access SCM Monitor (only visible when SCB installation mode / license active)

To access the SCB Monitor menu, go to [Diagnostic | Components | SCB Monitor](#).

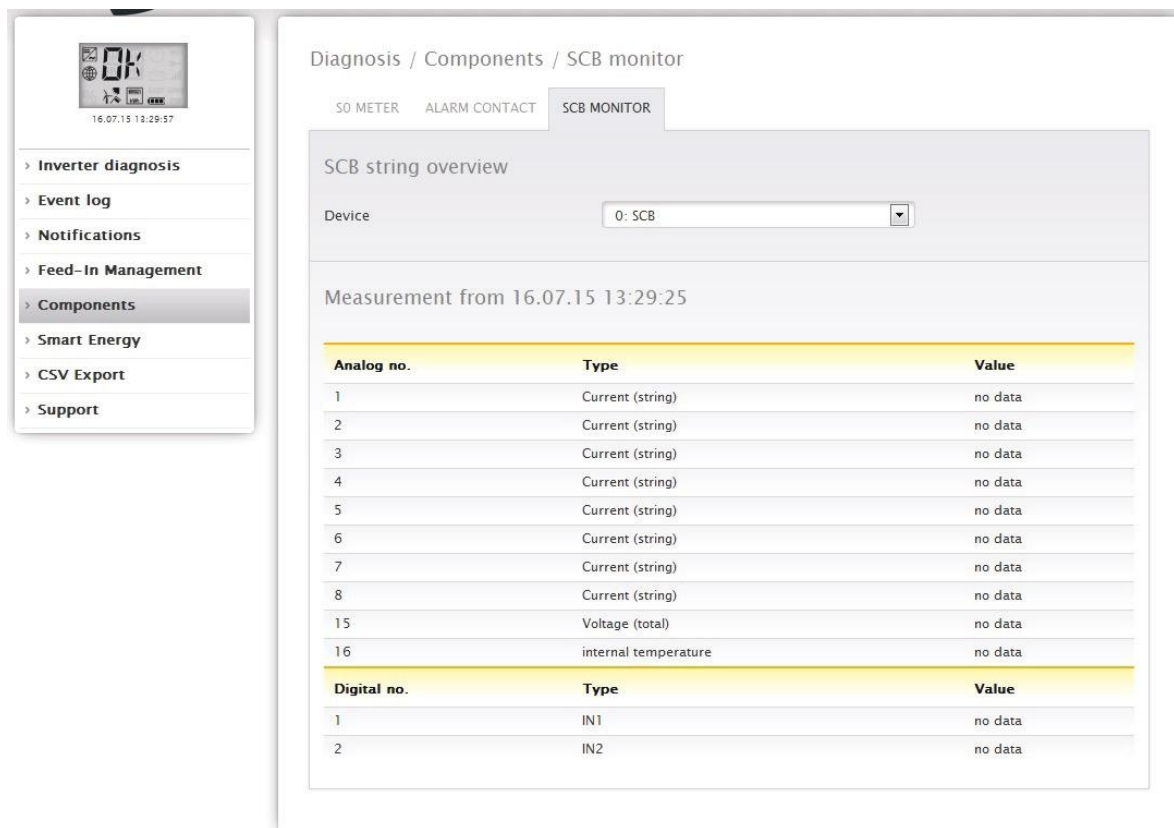

The screenshot shows the SCB Monitor interface. On the left is a sidebar menu with the following items: Inverter diagnosis, Event log, Notifications, Feed-In Management, Components (highlighted), Smart Energy, CSV Export, and Support. The main display area is titled 'Diagnosis / Components / SCB monitor' and has three tabs: SO METER, ALARM CONTACT, and SCB MONITOR. Below the tabs is a section titled 'SCB string overview' with a 'Device' dropdown menu set to '0: SCB'. Below this is a timestamp 'Measurement from 16.07.15 13:29:25'. The main content consists of two tables:

Analog no.	Type	Value
1	Current (string)	no data
2	Current (string)	no data
3	Current (string)	no data
4	Current (string)	no data
5	Current (string)	no data
6	Current (string)	no data
7	Current (string)	no data
8	Current (string)	no data
15	Voltage (total)	no data
16	internal temperature	no data

Digital no.	Type	Value
1	IN1	no data
2	IN2	no data

Fig.: Example of the SCB string overview

The [SCB String Overview](#) is displayed in a split-screen window. The connected devices (SCBs) can be individually accessed in the top screen via the pull-down menu.

The bottom screen displays the current measurements of the individual strings based on the analog and digital number.

Note!



Refer to the SCM manual for a detailed description.

13.7 Smart Energy

The following tabs are visible under the Smart Energy menu:

- Status (current).
- History.
- Simulation.

Status (current) section

The following values are displayed as a table in the [Status \(current\)](#) tab:

- Averaging (is visible when managing with average values)
- Total Plant.
- Priority List:

There is also the option in this section to directly switch to the configuration of the Smart Energy switching group by clicking on the arrow symbol  in the top right corner.

13.7.1 Explanations of the terms

Averaging

The last time that the average value was calculated can be determined based on the countdowns in the averaging field.

Note!



The average value consists of the 5-, 10- or 15-minute average value depending on the number of connected inverters:
 < 30 INV: 5 minutes, 30-59 INV: 10 minutes, >= 60 INV: 15 minutes

Internal processes, e.g. HTTP transmission or communication with the inverters, may cause a delay in the interval. In such cases, the countdown remains at "0" until the interval has been calculated.

Total Plant

The following values can be viewed under plant-wide:

- **Production:**
The production from the entire plant in watts. Current or average value (this value is recorded directly from all producers).
- **Consumption:**
The entire consumption in watts. Current or average value (this value is recorded directly from all consumption meters).
- **Remaining surplus:**
Surplus that is still fed into the grid. Current or average value (calculation [production - consumption]).
- **Smart Energy Consumption:**
This value is comprised of the nominal power or of the retrievable output from all of the currently active profiles and the current output from the controlled smart appliances. Current or average value.
- **Smart Energy Production (is only visible when at least one switching group is defined as a generator)**
The value indicates all of the current power output (e.g. CHP) that is currently active via the Solar-Log™. Current or average value.
- **Theoretical surplus:**
The theoretical surplus is the amount that would be fed into the grid if no Smart Energy logic was operating (including smart appliances). It is calculated accordingly: [(Production-Smart Energy Production)-(Consumption Smart Energy Consumption)]. Current or average value.

The selection for "Measurement values for control logic" under [Configuration | Smart Energy | Surplus management](#) determines whether the current values or average values are displayed for the status.

Priority List

The priority of the defined control logics are displayed under the Priority list. (See illustration: "Smart Energy Status (current)")

Diagnostics / Smart Energy / Status (current)

STATUS (CURRENT) HISTORY SIMULATION

Status (current)

Averaging in

plant-wide		Average
Production	<input type="text" value="20037"/>	W
Consumption	<input type="text" value="5646"/>	W
Remaining surplus ?	<input type="text" value="14391"/>	W
Charge	<input type="text" value="0"/>	W
Discharge	<input type="text" value="0"/>	W
Smart Energy Production	<input type="text" value="3000"/>	W
Smart Energy Consumption	<input type="text" value="0"/>	W
Theoretical surplus ?	<input type="text" value="11391"/>	W

Priority list

Priority 1 - BHKW Steuerung 1

Available surplus ?	<input type="text" value="11391"/>	W
Last surplus change	<input type="text" value="14:20:06"/>	
Switching status		
Production	<input type="text" value="3000"/>	W

Priority 2 - EGO

Available surplus ?	<input type="text" value="14391"/>	W
Last surplus change	<input type="text" value="14:20:11"/>	
Temperatur	<input type="text" value="54"/>	°C
Consumption	<input type="text" value="3500"/>	W

Fig.: Smart Energy Status (current)

Depending on the device or profile type selected, different information is displayed. For example: available surplus, runtime, temperature and charging states when a hybrid or battery system is connected. By clicking on the question mark the current configuration for the switching groups is displayed without switching to the configuration section.

13.7.2 History Section

Daily graphics, all of the configured control logics and the intelligent appliances are displayed according to their priority in the **History** tab. All of the relevant data for the particular device is displayed in the graphic. Each graphic has the curves "Total production," Total consumption" and "Total surplus." This is identical for every graphic and is part of the overview with the plant-wide values. (See illustration: "Smart Energy History - Example with EGO Smart Heater - Surplus Priority 1"): All of the values displayed in the key can be selected and deselected at anytime with a left-click to display individual values (curve) or to display or hide all values (curves). With a right-click, all of the values (curves) other than the one selected can be hidden.



Fig.: Smart Energy History - Example of Priority 1

Depending on the connected device and configured control logic the labels may be different and also the values may vary (e.g.: runtime and switching status as well as charging states when a hybrid or battery system is connected).

Note!



The selected section can be enlarged by clicking on the graphic and dragging it.

Certain days can be selected to be viewed with the [Date](#) box. It is possible to scroll the dates back and forth with the arrow buttons. The individual values that are displayed at the top-left of the graph key can be explicitly displayed or hidden with a mouse click.

Basic View

The basic view can be activated with a button.

If this option is selected for a basic surplus rule in which all of the contacts are switched together only the curves of the first contact are displayed in order to maintain a clear overview in the graphic.

There is the option to directly switch to the configuration of the Smart Energy switching group by clicking on the arrow symbol  in the top right corner.

13.7.3 Simulation Section

The configured control logics can be simulated under the Simulation tab to check if the logics are correct. The simulation is always based on the the underlying calculated averages.

(See the example Figure: "Smart Energy - Simulation with EGO - Surplus Priority 1").

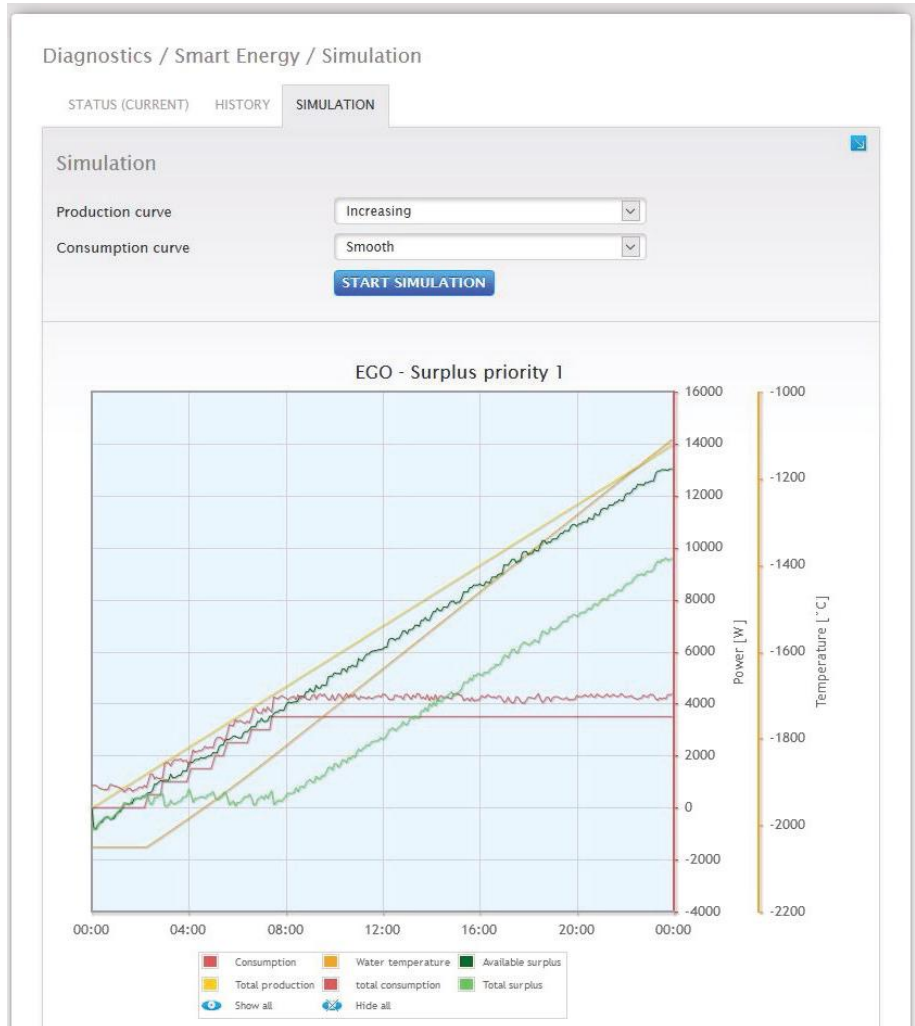

Fig.: Smart Energy - Simulation with EGO - Surplus Priority 1

Similar to the History view, there are various values displayed in the graphic view. These values depend on the particular connected device and/or configured control logic.

All of the values displayed in the key can be selected and deselected at anytime with a left-click to display individual values (curve) or to display or hide all values (curves). With a right-click, all of the values (curves) other than the one selected can be hidden.

In the simulation, different view options can be selected for the production and consumption curves.

The following options can be selected:

- Production curve
 - Zero line
 - Increasing
 - Decreasing
 - Constant (a fixed value in watts can be defined here)
 - Normal levels of irradiation
 - Very high levels of irradiation
 - Low levels of irradiation
 - Inconsistent levels of irradiation
 - Selected day (a particular day can be selected here)
- Consumption curve
 - Zero line
 - Increasing
 - Decreasing
 - Constant (a fixed value in watts can be defined here)
 - Normal
 - Smooth
 - Jagged
 - Selected day (a particular day can be selected here)

There is the option to directly switch to the configuration of the Smart Energy switching group by clicking on the arrow symbol  in the top right corner.

Note!



For more information on Smart Energy (such as configuration, functionality and application examples), refer to the Chapter: "Menu Configuration - Smart Energy" or go to our website (<https://www.solar-log.com/en/support/downloads/manuals/>).

13.8 Accessing Support

To access the Support menu, go to [Diagnostic | Support](#).

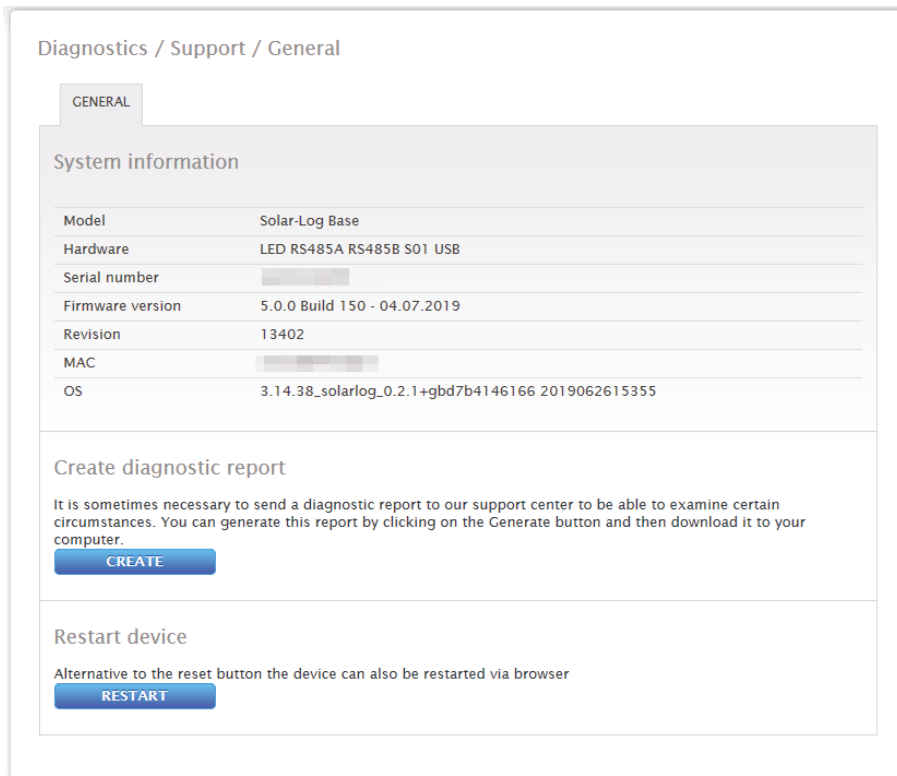

Fig.: Support - General

There are three sections under the [Support | General](#) menu:

- System Information:

The following information is available in this tab:

- Model (type of Solar-Log™).
- Hardware (hardware components available for the device).
- Solar-Log™ serial number.
- Firmware Version and date.
- Revision number.
- MAC (MAC address of the device).
- OS (Operating System of the Solar-Log™).

- Creating diagnostic reports:

You have the option to create and download a diagnostic report. This can be sent to Solar-Log support for analysis.

See Figure: Support - General.

- Restart

As an alternative to the reset button the device itself, the Solar-Log™ can be rebooted with the restart button in the WEB menu.

14 Yield Data Menu

Click on Yield Data in the **tool bar** to access the **Yield Data** menu.

The following options can be selected from the left-side navigation menu.

- Current values
- Production
- Consumption (only appears when a consumption meter is connected)
- Balances
- Sensor (only appears when a sensor is connected)

14.1 Current values

The **Cockpit** tab can be automatically selected from the **Current values**. The Dashboard view of the plant includes the following values:

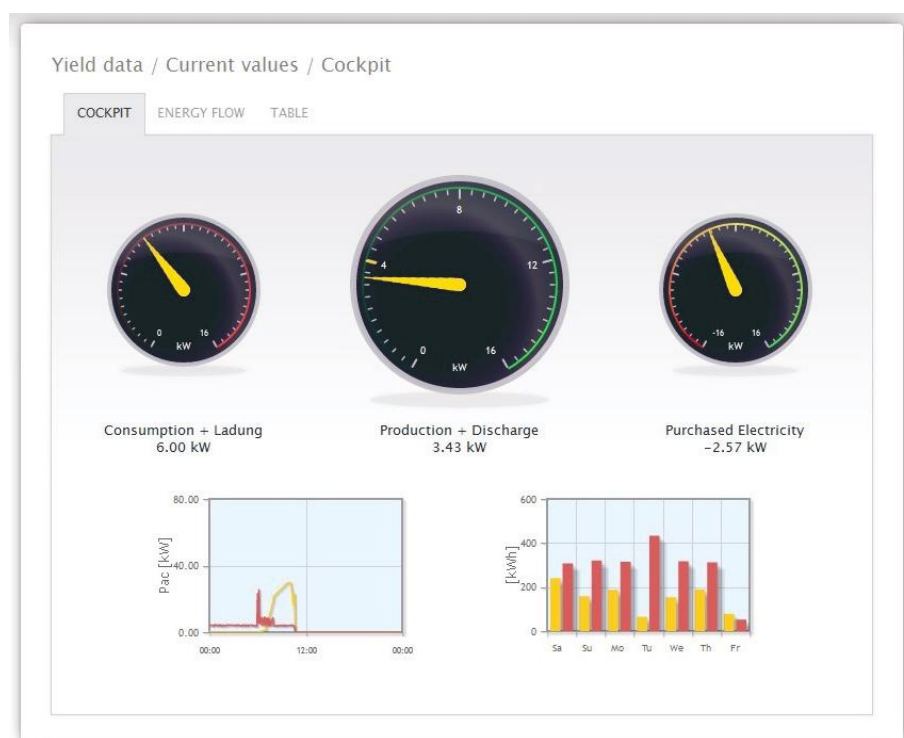

Fig.: The plant's current values (cockpit view)

- Consumption (only when consumption meters are connected). This displays the current consumption.
- Production (power generated by the plant) + discharge *only with a connected battery system) displays the current production and battery discharge.
- Feed-in amount (only when meters are connected). This displays the power output that is currently being fed into the grid.

There are two graphs located below the Dashboard display:

- The current day curve (graph on the left):
There is also the option to display the previous six days as a curve in this graph. Therefore, just click on the day value in the graph on the right.
- The current day value as well as those from the previous 6 days (graph on the right):
Move the mouse above one of the bars to display the day value. Click on one of the bars to have it display in the graph on the left as a curve.

Additional tabs can be selected in this view:

- Energy flow
- Table

Note!



If the Solar-Log™ is just used as a consumption monitoring tool, the menu is limited to [Current values](#), [Consumption](#) and [System information](#). All of the other menus are hidden.

Note!



When only consumption meters are connected to the Solar-Log™, a large consumption tachometer is displayed instead of the production tachometer in the [Current values | Cockpit](#) menu.

14.1.1 Energy flow

The plant is displayed as a flow graphic in the Energy flow tab.

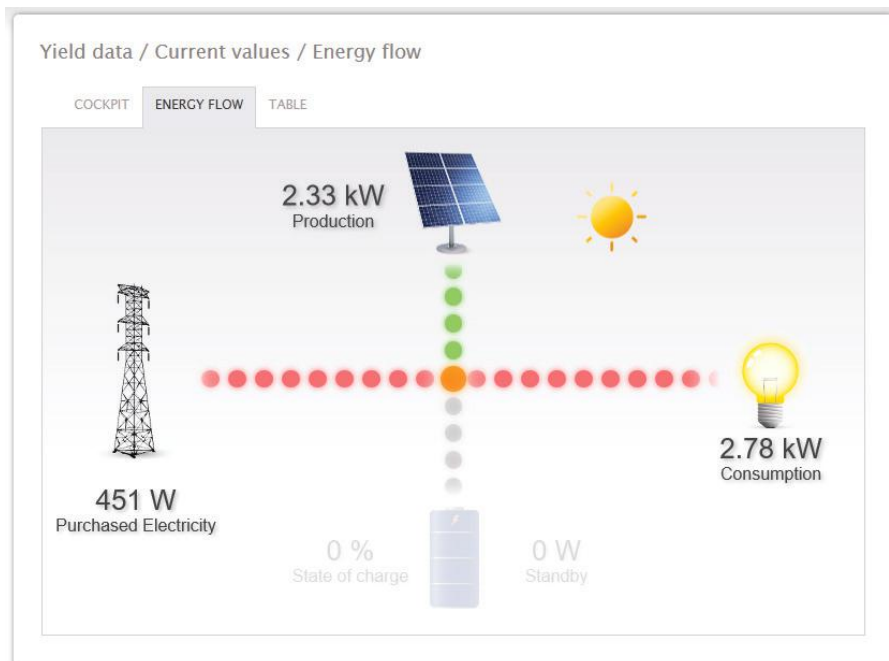

Fig.: Example of a plant with an energy flow

Depending on the particular devices connected, the following values are displayed in the flow graphic in real time:

- Production (W)
- Consumption (W)
- Grid fed / purchase from grid (W)
- Battery Status
 - Charge Status (%)
 - Charge / Discharge Output (W)

Note:

When a battery meter is connected, the value for the battery's charge status cannot be read. That is why for the presentation of energy flows that the charge status is displayed with n/a and the charge with 0 W.

Energy Flow Color Key

- Production (W):
 - Green, energy is being generated.
 - Gray, energy production is not active.
- Consumption (W):
 - Red, energy is being consumed.
 - Grey, no active consumption.
- Grid fed / purchase from grid (W)
 - Red, energy is being purchased from the grid.
 - Green, energy is being fed into the grid.
 - Gray, no energy transfer in either direction with the grid.

Battery:

- Charge Level (%):
 - Red, battery is being charged.
- Discharge (W):
 - Green, battery is being discharged.

14.1.2 Table

The output recorded from the connected devices is displayed as a table in Table tab.



The screenshot shows a web interface with the title 'Yield data / Current values / Table'. At the top, there are three tabs: 'COCKPIT', 'ENERGY FLOW', and 'TABLE', with 'TABLE' being the active tab. Below the tabs is a table with two main sections. The first section is titled 'Inverters' and has three columns: 'Inverters', 'Power', and 'Status'. It contains two rows: 'WR 1' with a power of 1171 W and status '0-Erst.Einsch.', and 'WR 2' with a power of 1171 W and status '0-Erst.Einsch.'. The second section is titled 'Consumption meter' and also has three columns: 'Consumption meter', 'Power', and 'Status'. It contains one row: 'Consumption' with a power of 2777 W and status 'RUNNING'.

Inverters	Power	Status
WR 1	1171 W	0-Erst.Einsch.
WR 2	1171 W	0-Erst.Einsch.

Consumption meter	Power	Status
Consumption	2777 W	RUNNING

Fig.: Table with the recorded output from an example plant

Depending on the particular device connected, the following values are displayed:

- The current output from each individual inverter.
- The total current consumption as measured by the consumption meters.
- The current irradiation per m² as measured by the sensor.
- The values from the battery with the columns Charge/Discharge, Charge Level (%) and Status.

14.2 Production

You can select a graphic display of your plant's production from the [Production](#) menu.



Fig.: Graphic display of the plant's total production

You can select the following tabs from this display:

- Day
- Month
- Year
- Total

You can select to display the view as a [Graph](#) or [Table](#). The actual values displayed in the graph or table depend on the view selected.

Note!



The auto scaling option always scales the graphics up as much as possible. The auto scaling can be manually disabled for the respective graphics. Then the scaling is done based on the value defined in the device configuration. Please refer to the the chapter on configuring inverters in the Installation Manual.

The selected section can be enlarged by clicking on the graphic and dragging it.

14.2.1 Day view

The **Day** tab displays the current day as a curve graph. The values **Output (W)** and **Yield (kWh)**, on the top left of the diagram key, can be selected and deselected at anytime with a left-click to display individual values (curve) or to display or hide all values (curves). With a right-click, all of the values (curves) other than the one selected can be hidden.

The different values throughout the day can be displayed by moving the mouse along the curve.

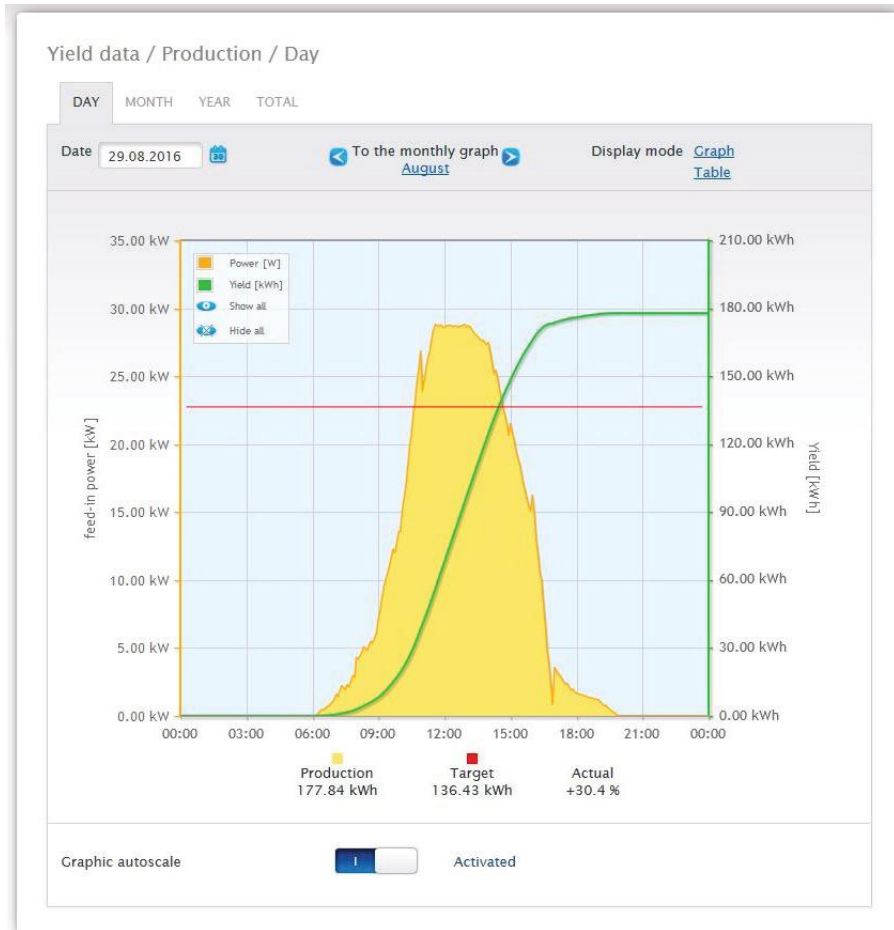

Fig.: Daily View of the Production Graph with the Auto Scaling activated

The following data is graphically displayed in the production day:

- Production (kWh) (If the daily yield value is modified with the data correction function, the modifications are displayed in brackets.)
- Target (kWh).
- Current (%).

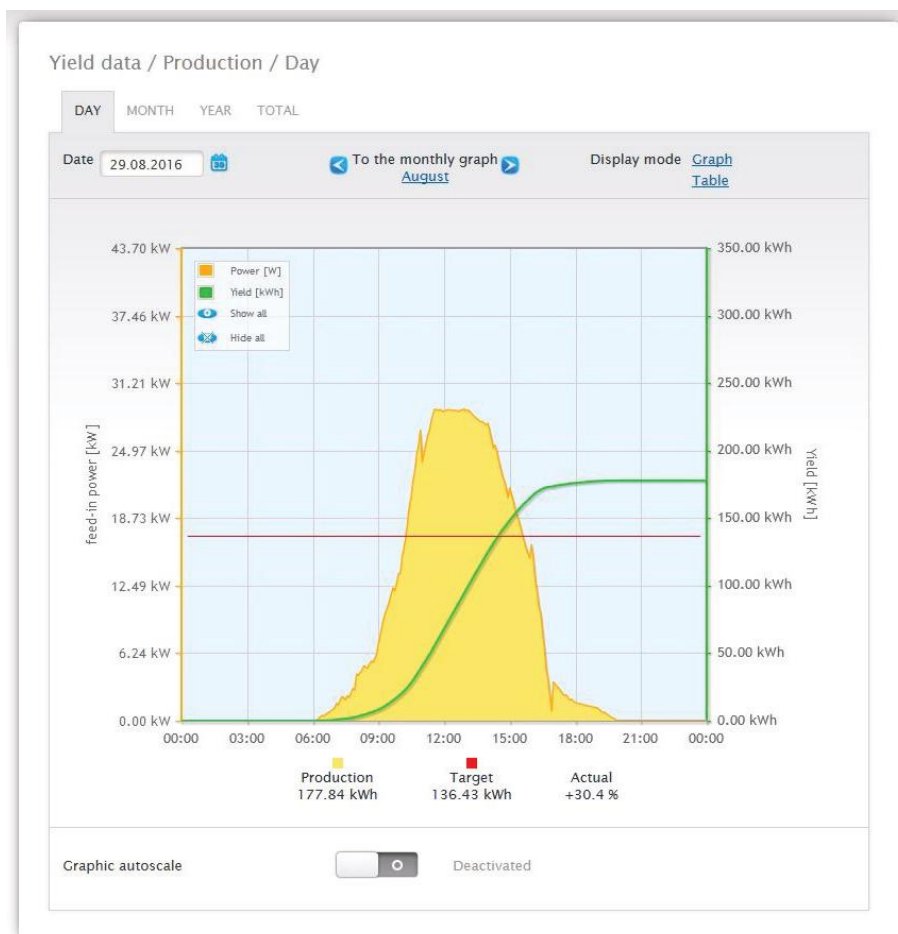

Fig.: Daily View of the Production Graph with the Auto Scaling deactivated

Different values with different units are displayed in the graph. The units used and their colors are defined in the key at the top.

Inverter	Name	Yield	Specific Yield
0	INV 3	12.33	0.84
1	INV 1	12.33	0.84
2	INV 2	12.33	0.84
Total		36.99	0.84

Fig.: Day view of the production table

When you click on **Table**, the values from the current output generated will be allocated to the individual inverters and displayed as a table. In this way, you can check the output of every individual inverter at any time.

14.2.2 Month view

The tab **Month** displays the daily yields from the month as a total in a bar graph.

- The daily yield can be displayed by moving the mouse above one of the bars.
- Click on a bar to go to the corresponding day view.



Fig.: Month view production graph

Yield data / Production / Month

DAY MONTH YEAR TOTAL

Date 07.2015 [To the yearly graph 2015](#) Display mode [Graph](#) [Table](#)

Date	Yield	Specific Yield	set value (cumulative)	Actual
01.07.2015	37.24	0.84	164.59	-77.4
02.07.2015	196.63	4.46	164.59	+19.5
03.07.2015	248.10	5.63	164.59	+50.7
04.07.2015	207.53	4.71	164.59	+26.1
05.07.2015	92.05	2.09	164.59	-44.1
06.07.2015	256.50	5.82	164.59	+55.8
07.07.2015	190.44	4.32	164.59	+15.7
08.07.2015	256.96	5.83	164.59	+56.1
09.07.2015	206.11	4.67	164.59	+25.2
10.07.2015	250.47	5.68	164.59	+52.2
11.07.2015	192.38	4.36	164.59	+16.9
12.07.2015	262.36	5.95	164.59	+59.4
13.07.2015	172.61	3.91	164.59	+4.9
14.07.2015	209.98	4.76	164.59	+27.6
15.07.2015	206.92	4.69	164.59	+25.7
16.07.2015	182.53	4.14	164.59	+10.9
17.07.2015	190.88	4.33	164.59	+16.0
18.07.2015	103.41	2.34	164.59	-37.2
19.07.2015	256.18	5.81	164.59	+55.6
20.07.2015	204.46	4.64	164.59	+24.2
21.07.2015	253.74	5.75	164.59	+54.2
22.07.2015	173.99	3.95	164.59	+5.7
23.07.2015	199.46	4.52	164.59	+21.2
24.07.2015	259.53	5.88	164.59	+57.7
25.07.2015	36.99	0.84	164.59	-77.5
26.07.2015	249.52	5.66	164.59	+51.6
27.07.2015	11.05	0.25	164.59	-93.3
28.07.2015	0.00	0.00	164.59	-100.0
29.07.2015	0.00	0.00	0.00	0.0
30.07.2015	0.00	0.00	0.00	0.0
31.07.2015	0.00	0.00	0.00	0.0
Total	5108.04	115.83	4608.59	+10.8

Fig.: Month view of the production table

When you click on [Table](#), the values: date, yield, specific yield and target (cumulative), current and target are listed for the entire month.

14.2.3 Year view

The tab **Year** displays the monthly yields from the year as a total in a bar graph.

- Move the mouse above one of the bars to display the monthly yield with a comparison of the current and target values in regard to the annual forecast.
- Click on a bar to go to the corresponding month view.



Fig.: Year view graph

When you click on **Table**, the annual values for the entire year are allocated to each month according to the actual output generated.

14.2.4 Total view

The **Total** tab displays the annual yields as a total in a bar graph. The red line displays the calculated target balance based on the annual forecast.

- Move the mouse above one of the bars to display the annual yield with a comparison of the current and target values in regard to the annual forecast.
- Click on a bar to go to the corresponding year view.



Fig.: Total view graph

Table:

The plant's total power output (since the monitoring started) is allocated every each according to the output generated.

The **Date box** is included in the day, month and year view and has a calendar function with which you can search for certain days, months or years according to the view selected. You can go backwards and forwards within the selected period with the arrow keys for the previous day or week, or for the following day or week.

14.3 Consumption (only when consumption meters are connected)

From the [Consumption](#) menu, you can view the exact consumption from appliances that are connected via networked "smart plugs" with the Solar-Log 1200, 1900 and 2000 or via a relay.

Note!



Consumption is only displayed once a meter is connected.

The day view can be selected from the [Consumption](#) menu. The view appears as a [Day Graph](#) with the total consumption values.

As soon as sub-consumers are connected, e.g. a washing machine or freezer, the view expands to include the tab [Details Sub-consumers](#).

All of the appliances consuming electricity are shown in different colors here and they are also displayed as in a pie chart at the bottom with the colors in the key.

It is also possible to display the Daily Consumption graphic as a line graphic. There is the option to display or hide the consumption from particular appliances in line graphic view.



Fig.: Graph of daily consumption with meters connected



Fig.: Graph of daily consumption with meters connected and active line graphics



Fig.: Graph of daily consumption with connected appliances in the sub-consumer view



Fig.: Graph of daily consumption with connected appliances and active line graphics in the sub-consumer view

You have the option to select additional menu items in the consumption view.

- **Month:**

displays the Month Graph View as a bar graph. There are two tabs in the Month View, the same as in the Day View: The [Consumption Overview](#) and the [Sub-consumer Overview](#).

The total consumption values are displayed in the Consumption Overview as a bar graph.

In the [Sub-consumer Overview](#), you see the devices connected as a bar graph with the power consumption displayed in different colors. Below this, the values are also displayed in a pie chart with the colors in the key.

There is the option from both views to select the days directly from the individual bars and sections.

- **Year:**

displays the Year Graph View as a bar graph. There are two tabs in the Year View, the same as in the Month View:

The [Consumption Overview](#) and the [Sub-consumer Overview](#).

The total consumption values are displayed in the Consumption Overview as a bar graph.

In the [Sub-consumer Overview](#), you see the devices connected as a bar graph with the power consumption displayed in different colors. Below this, the values are also displayed in a pie chart with the colors in the key.

There is the option from both views to select the individual months directly from the individual bars and sections.

- **Total:**

displays the Total Graph View as a bar graph. There are two tabs in the Total View, the same as in the Year View:

The [Consumption Overview](#) and the [Sub-consumer Overview](#).

The total consumption values are displayed in the Consumption Overview as a bar graph.

In the [Sub-consumer Overview](#), you see the devices connected as a bar graph with the power consumption displayed in different colors. Below this, the values are also displayed in a pie chart with the colors in the key.

There is the option from both views to select the individual years directly from the bars and sections.

14.4 Balances

You can see the relationship between your plant's production and consumption from the [Balances](#) menu. The following points are displayed in all of the views (day, month, year and total):

- Production
- Consumption
- Self-consumption

The following factors additional displayed when a battery system is connected (see Fig.: Day Balance graph with battery system):

- Self-consumption Battery (kWh)
- Charge (kWh)
- Discharge (kWh)

Note!



The consumption as well as the values from the battery are only displayed once the systems are connected (consumption meter + battery system).

Note!



The auto scaling option always scales the graphics up as much as possible. The auto scaling can be manually disabled for the respective graphics. Then the scaling is done based on the value defined in the device configuration.

The selected section can be enlarged by clicking on the graphic and dragging it.

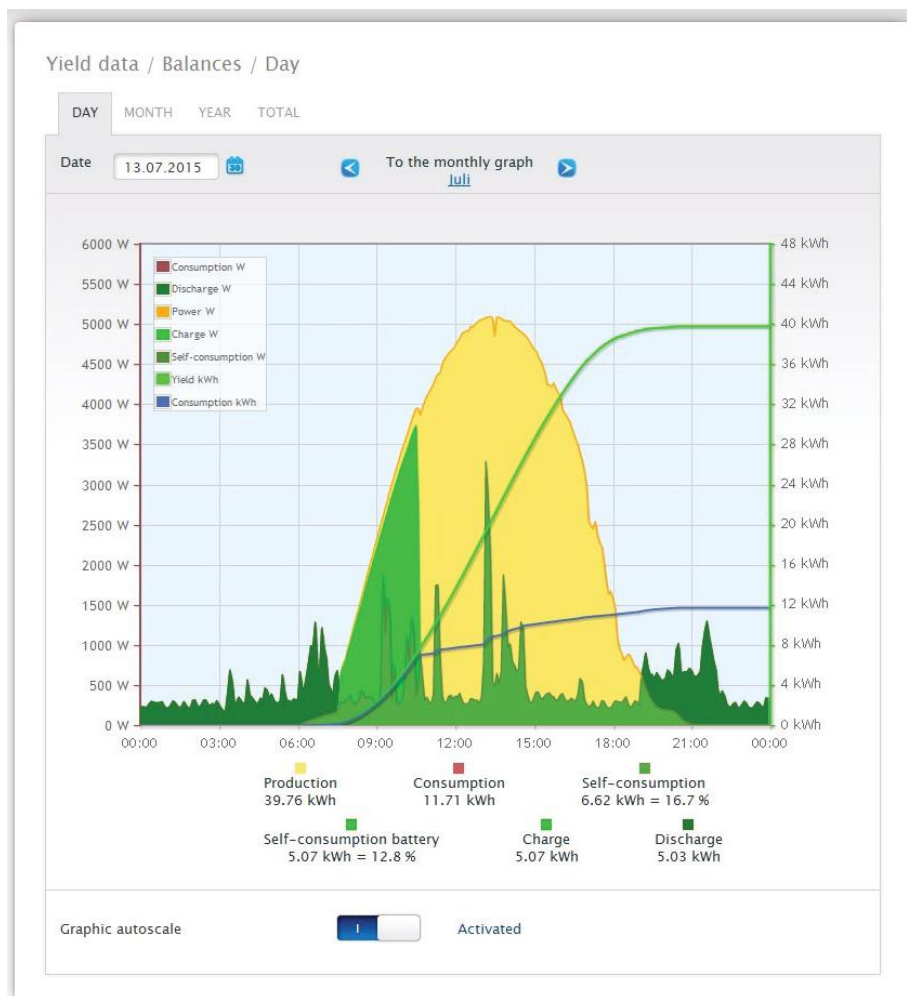

Fig.: Day Balance graph with battery system

The following tabs can be selected:

- Day
- Month
- Year
- Total

The start view displays the current daily values as a graph.

14.4.1 Day balance

The **Day** tab under Balances displays the production, consumption and self-consumption side-by-side as a day curve. The values in the diagram key, can be selected and deselected at anytime with a left-click to display individual values (curve) or to display or hide all values (curves).

With a right-click, all of the values (curves) other than the one selected can be hidden.

Different values with different units are displayed in the graph. The units used and their colors are defined in the key at the top.

The different values throughout the day can be displayed by moving the mouse along the curve.

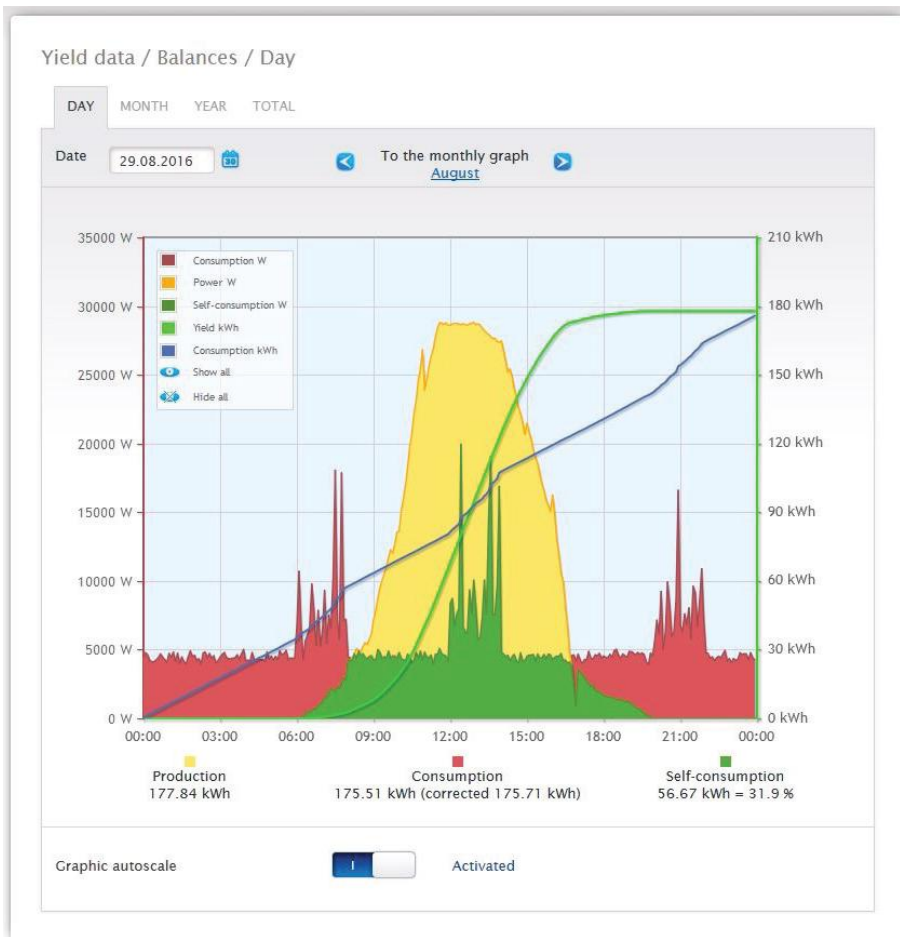

Fig.: Daily Balance Graph with the Auto Scaling activated

The following data is graphically displayed in the daily balance:

- Production (kWh).
- Consumption (kWh) (If the daily consumption value is modified with the data correction function, the modifications are displayed in brackets.)
- Self-consumption.

The meaning of the colored areas in the day curve:

The green areas display the amount of consumption that was covered with PV power. The yellow areas display the surplus of PV-generated power and the red areas display the amount of consumption that was not covered with PV power.

You have a choice between the **Graph** and **Table** display mode.

General definition of the different colored areas within the balance graphs:

(see figure: Daily Balance Graph)

- Yellow areas - Production.
- Red areas - Consumption (Total = not covered by production (red in the graph) + covered by production (green in the graph)).
- Green area - self-consumption (covered by production - green in the graph) with a percentage (in relation to production).

14.4.2 Month balance

The tab **Month** under balances displays the production and consumption side-by-side in a bar graph.

- Move the mouse above one of the bars to view either the daily yield or consumption.
- Click on one of the bars to go to the corresponding day view.



Fig.: Month view balance graph

14.4.3 Year balance

The Year tab under Balances displays the production and consumption side-by-side in a bar graph.

- Move the mouse above one of the bars to view either the monthly yield or consumption with a comparison of the current and target values in regard to the annual forecast.
- Click on one of the bars to go to the corresponding month overview.

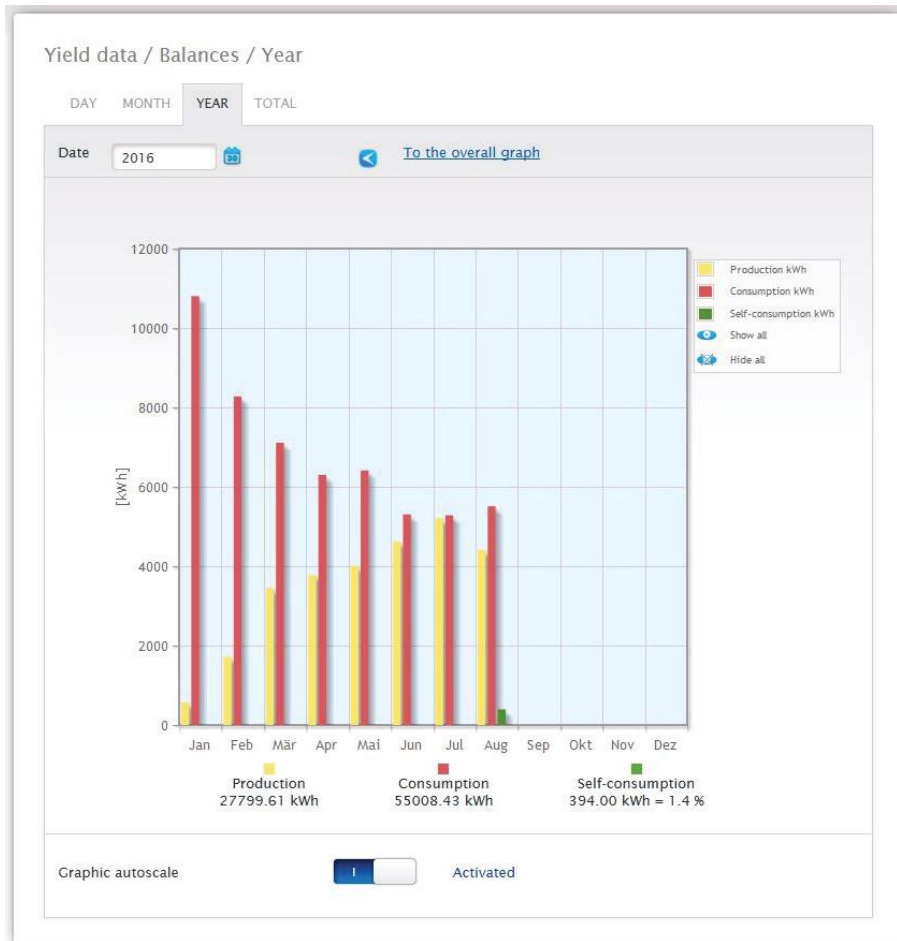

Fig.: Year view balance graph

14.4.4 Total balance

The **Total** tab under Balances displays the production and consumption side-by-side in a bar graph.

- Move the mouse above one of the bars to view either the annual yield or consumption with a comparison of the current and target values in regard to the annual forecast.
- Click on one of the bars to go to the corresponding annual overview.

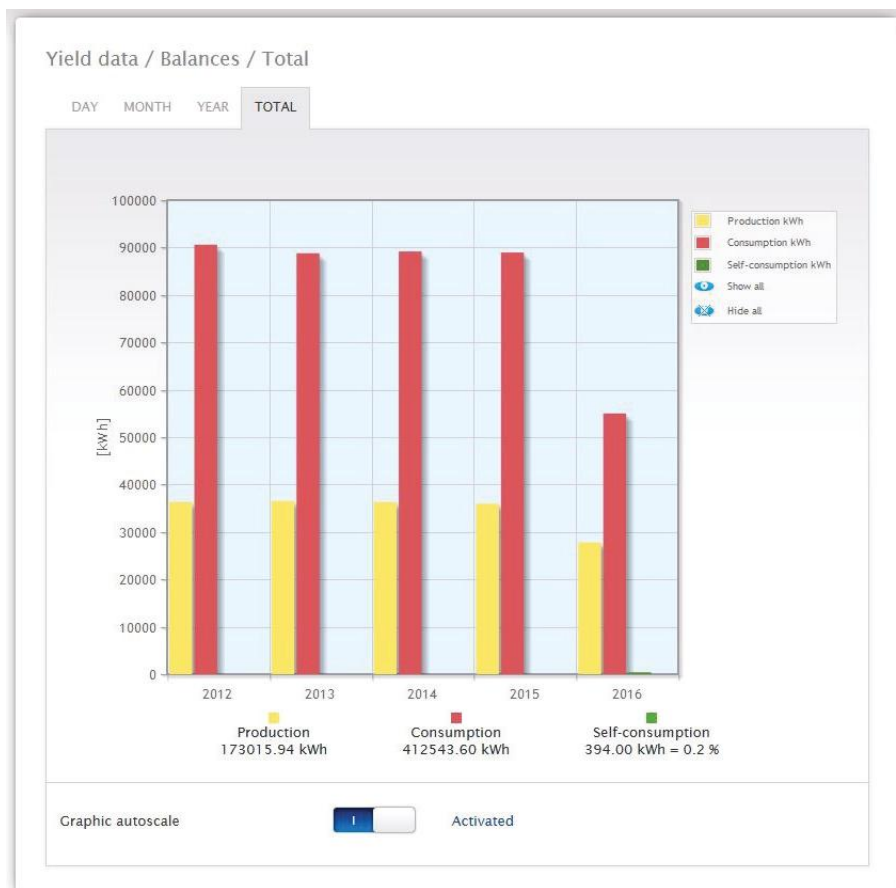

Fig.: Total balance graph

14.5 Sensor (only when connected)

A graphic evaluation from the connected sensors can be displayed from the **Sensor** menu.

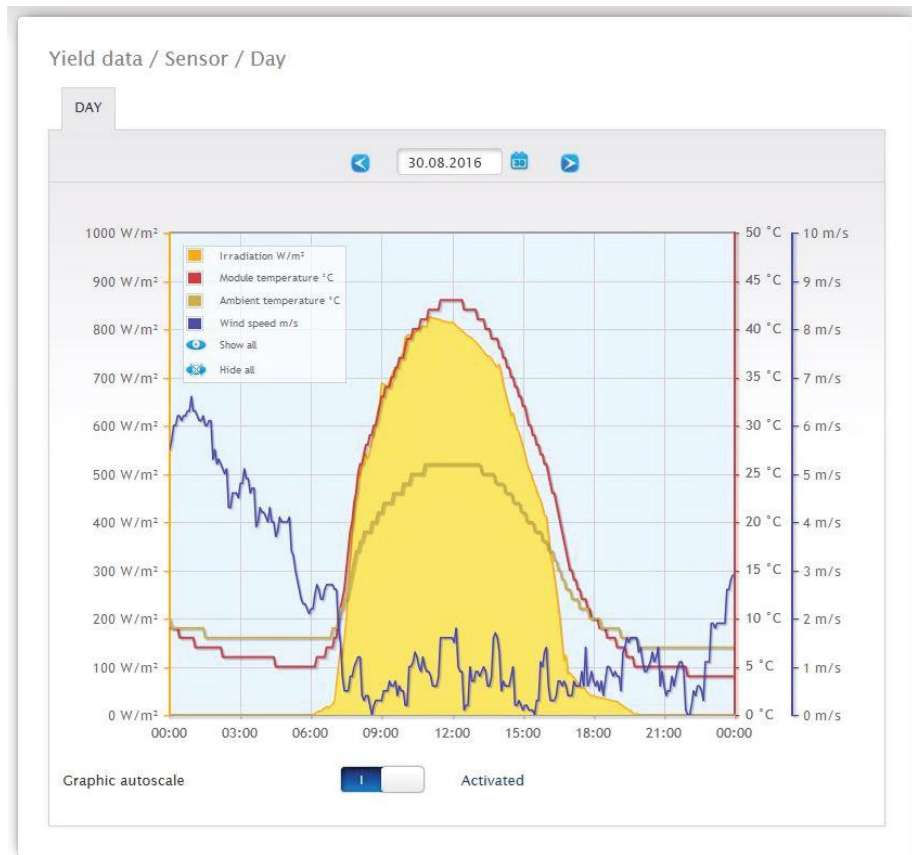

Fig.: Graph of Sensor Box values

The following values can be displayed individually:

- Irradiation W/m².
- Module temperature C°.
- Ambient temperature C°.
- Wind speed m/s.

Different values with different units are displayed in the graph. The units used and their colors are displayed in the key at the top.

All of the values displayed can be selected and deselected at anytime with a left-click to display individual values (curve) or to display or hide all values (curves). With a right-click, all of the values (curves) other than the one selected can be hidden.

You can select and subsequently evaluate certain days with the Date box.

Note!







The menu is only visible once a meter is connected.

15 Display Definition

The following sections can be accessed with the touch function (swiping up, down, to the right or to the left).

- Values
- Status
- Configuration
- Installation
- QR Code

15.1 Generation Display Controls

Controls	Meaning	Further explanation
	Swipe to the right	When the displays spans several pages, tap on the arrow to go to the next page and back to the previous page.
	Swipe to the left	
	Swipe up	
	Swipe down	

15.2 Values

The values are displayed as a cockpit or energy flow graphic. The following values can be displayed in the cockpit graphic:

- Production
- Consumption
- Battery (when connected)
- Feed-in

Values



Cockpit



Energy flow



The Energy Flow graphic displays:



Fig.: Example of a plant with an energy flow

Depending on the particular devices connected, the following values are displayed in the energy flow graphic in real time:

- Production
- Consumption
- Grid Fed / Purchase from Grid
- Battery Status (only when connected)
 - Charge status
 - Charge / Discharge Output

Note:

When the battery is not connected directly, but via a battery meter (bi-directional meter), the battery charge status is not displayed. That is why for the presentation of energy flows that the charge status is displayed with n/a and the charge with 0 W.

Energy Flow Color Key

- Production:
 - Green, energy is being generated.
 - Gray, energy production is not active.
- Consumption:
 - Red, energy is being consumed.
 - Grey, no active consumption.
- Grid fed / purchase from grid:
 - Red, energy is being purchased from the grid.
 - Green, energy is being fed into the grid.
 - Gray, no energy transfer in either direction with the grid.

Battery:

- Charge:
 - Red, battery is being charged.
- Discharge:
 - Green, battery is being discharged.

The values, production, consumption and surplus are displayed in the balance (energy balance).

15.3 Status

Here the detected devices and device status of the individual components (e.g. whether online or offline) are displayed.

Status



Devices



Device Status (1)

Device Status (2)



15.4 Configuration

The network and Internet settings can be viewed in the configuration section. The network settings can also be reset and the factory settings restored.

Configuration



Network Settings (1)



Network Settings (2)



Network Settings (3)



Internet Settings



Reset (1)



Reset (2)



15.5 Installation

The plant name, the size of the plant as well as the device name and the serial number can be viewed from the "Installation" menu. Missing licenses and their article numbers are also displayed.

Installation



General



Licenses (1)



Licenses (2)



15.6 QR Code

QR codes, for example, can be displayed and/or processed via a smartphone.

- Info Center
- Licenses

QR Code



Info Center



Licenses



Note!



A QR code scanner has to be installed on the smartphone in order to read the QR codes.

15.7 Solar-Log Base LEDs

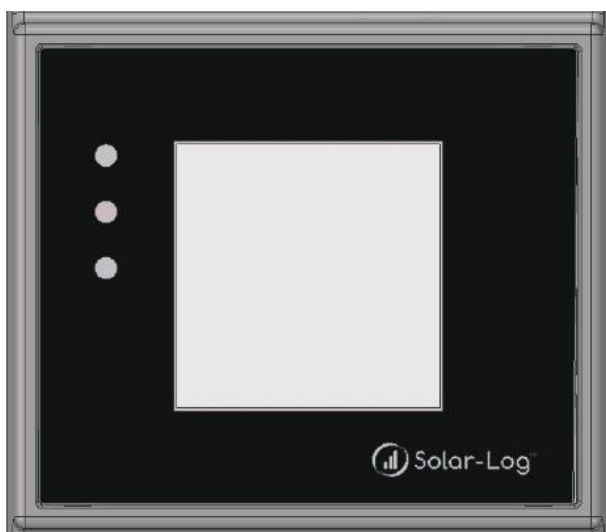

Fig.: Display with LEDs

Depending on the operating state, the LEDs can be lit up continuously in different colors.

Normal operation

Solar-Log Base - LEDs (from top to bottom)

Name	Color	Meaning
Power (top)	is green	Power supply available
Internet (middle)	is red	No Internet connection. ▶ Check the network cables.
Internet (middle)	is orange	DNS failure.
Internet (middle)	is green	Internet connection available
Components (bottom)	is red	Connection lost to at least one component.
Components (bottom)	is green	Normal operation. Connection established to the components. (The LED is also green when there is no solar irradiation, e.g. night shut-off)

16 Faults

16.1 Error messages

16.1.1 Fault messages time

These fault messages are displayed on the virtual LCD display

Fault messages Time

Error code	Message	Possible cause or remedy
		
1	No time/date set	Set the time and date or use the automatic time synchronization function
TM		Just like error 1 The names have been changed with Firmware 3.0.2.

16.1.2 Fault messages Internet

These fault messages are displayed on the VLCD display.

The Internet symbol blinks and the corresponding error code is displayed.

Fault messages Internet

Error code	Possible cause or remedy
	
1	Check the Internet connection and network configuration.
2	The active DNS server configured under Configuration Network Ethernet is not available. Check the configurations.
3	No DNS server available Check the configurations and make sure that the correct DNS server has been entered.
4	The configured DNS server is not available. Please enter the correct DNS server.
5	DNS server could not resolve the server address. Check the DNS server and the server address.

16.1.3 Portal Transfer Fault messages

Portal Transfer Fault messages

Error code	Message	Possible cause/remedy
101	The server address could not be resolved.	The access type was not configured. An alternative DNS server is required. The wrong server was entered. The network connection was disconnected and could not be reestablished.
102	Cannot open socket.	Possible causes: Unknown. If this error continues to occur, contact our technical support.
103	Cannot connect to the socket.	Possible causes: The connection is blocked by a firewall or a router. The wrong server was entered. The server is offline.
220	Authentication failure (portal)	The portal registration was done incorrectly. The portal was not configured for HTTP transfers. The wrong server was entered.
Other	General errors	There is detailed description of this error. If this error continues to occur, contact our technical support.

17 Cleaning and care

17.1 Cleaning tips

Important!



Disconnect the device from the power supply before cleaning it!

- Clean the device on the outside only with a dry, lint-free cloth.
- If the device is very dirty, it can be cleaned with a slightly damp cloth and a commercially available household cleaner.

Important!



When cleaning, make sure that no moisture gets into the device!

17.2 Care tips

- Make sure that the device is not exposed to any moisture or heat , as well as strong sunlight at the location where it is kept.

18 Disposal

Caution



Solar-Log™ contains electronic components that can release highly toxic substances if burned or disposed of along with domestic waste.

The Solar-Log™ can either be disposed of at a recycling center (electrical waste) or returned to the manufacturer Solare Datensysteme GmbH.

Solare Datensysteme GmbH
Fuhrmannstraße 9
72351 Geislingen-Binsdorf
Germany

19 Appendix

19.1 Internet ports

If the Solar-Log™ is connected to the Internet via a router, you must ensure that the following ports on the router have been unblocked for the Solar-Log™:

Function	Protocol	Port (outgoing)	Server used	Notes
Name resolution	DNS	53	According to the network configuration or 8.8.8.8 (Google Public DNS) when the name cannot be resolved with the dedicated DNS.	Normally, only the name server from the local network is used.
Time synchronization	NTP	123	0.pool.ntp.org to 3.pool.ntp.org ntp1-1.cs.tu-berlin.de bonehed.lcs.mit.edu navobs1.gatech.edu 130.149.17.8 130,207,244,240	This function ensures that the correct time is always in the logs. The Solar-Log™ has an internal clock, but it loses the time during a long power outage.
Easy Installation (WEB)	HTTP	80	pool0.solarlog-web.com to pool9.solarlog-web.com	A ping test is performed by the Easy Installation to test the Internet connection and if the DNS server functions.
	ICMP	-	solar-log.com	
HTTP Export	HTTP	80	According to the configuration.	
FTPS Export	FTP with SSL	21	According to the configuration	
Firmware update	HTTP	80	pool0.solarlog-web.com to pool9.solarlog-web.com	

19.2 Digital Interfaces

Solar-Log™ provides two interfaces for exporting the current data. The data is updated every 15-60 seconds.

Warning!



The following descriptions for two interfaces are intended for users with a technical background. Solare Datensysteme provides these interfaces without any guarantee and with the exclusion of any legal liability.

We do not offer any telephone support for these two interfaces.

19.2.1 Modbus TCP

The intention of this interface is to give easy access to the Solar-Log™ internal data for external SCADA like systems. The interface is designed to read out live data of the attached PV-system.

The interface is not designed to configure the Solar-Log™ or the attached devices. All configuration must be done via the standard Solar-Log™ Web access either local or remote.

ModbusTCP port:

- 502

Slave ID:

- 1

Implemented Modbus functions:

- 04 to read one or multiple 16 bit words
- 06 to write one 16 bit word
- 16 to write multiple 16 bit words

The Solar-Log™ Modbus implementation uses different byte and word orders. The Modbus protocol byte order follows the big-endian Modbus specification and is thus compatible with standard Modbus implementations. Therefore, the higher byte in value is transferred first.

The proprietary-specific register order for 32-bit values uses a little-endian word order. For a 32-bit value, the lower value word is stored in the first register and the higher value word in the second register.

19.3 Live data compact – summarized (complete plant)

Live data “compact” summarized is mapped from register 3500-3999.

Data	Unit	Value-Range	Adress	Number Reg.	Func Code	Since Firmware	Description
lastUpdateTime	Sec	32bit unsigned	3500	2	04		Unixtime when last register update has happened. 0=no live data yet
Pac	W	32bit unsigned	3502	2	04		Total Pac of all inverters and inv-type meters
Pdc	W	32bit unsigned	3504	2	04		Total Pdc of all inverters
Uac	V	16bit unsigned	3506	1	04		Average Uac of all inverters
Udc	V	16bit unsigned	3507	1	04		Average Udc of all inverters
Daily yield	Wh	32bit unsigned	3508	2	04		Summarized daily yield of all inverters
Yesterday yield	Wh	32bit unsigned	3510	2	04		Summarized daily yield of all inverters
Monthly yield	Wh	32bit unsigned	3512	2	04		Summarized monthly yield of all inverters
Yearly yield	Wh	32bit unsigned	3514	2	04		Summarized Yearly yield of all inverters
Total yield	Wh	32bit unsigned	3516	2	04		Summarized Total yield of all inverters
Pac consumption	W	32bit unsigned	3518	2	04		Total Pac of all consumption meters
Daily yield cons.	Wh	32bit unsigned	3520	2	04		Summarized daily yield of all consumption meters
Yesterday yield cons.	Wh	32bit unsigned	3522	2	04		Summarized daily yield (yesterday) of all consumption meters
Monthly yield cons.	Wh	32bit unsigned	3524	2	04		Summarized monthly yield of all consumption meters
Yearly yield cons.	Wh	32bit unsigned	3526	2	04		Summarized Yearly yield of all consumption meters
Total yield cons.	Wh	32bit unsigned	3528	2	04		Summarized Total yield of all consumption meters
TotalPower	Wh/Wp	32bit unsigned	3530	2	04		Total installed generator power

19.3.1 Open JSON Interfaces

The JavaScript Object Notation (JSON) is a compact data format to transmit data between applications. The objects documented here can be used in connection with other programs.

The open JSON interface can be activated and deactivated from the [Configuration | System | Access control](#) menu. When activating the interface, a red warning triangle with security information and risks is displayed.

Note



The open JSON interface is deactivated. To activate the open JSON interface, a user password must first be set.

The current data can be accessed via HTTP protocol. To do this an HTTP Post Inquiry needs to be sent to the Solar-Log™. The object requested has to be in the body:

```
POST /getjp HTTP/1.1
Host: solar-log-xxxx
...
Content Length: 20
Connection: keep-alive
Pragma: no-cache
Cache Control: no-cache

{,"801":{,"170":null}}
```

The reply contains a JSON object as a character string in the body:

```
HTTP/1.1 200 OK
Date: Mon, 26 Feb 2018 10:42:32 GMT
Server: IPC@CHIP
Content-Type: text/plain
Transfer-Encoding: chunked

{,"801":{,"170":{,"100": "26.02.18 10:42:15","101":0,"102":0,"103":0,"104":0,"105":0,"106":0,"107":3527647,"108":0,"109":0,"110":0,"111":0,"112":0,"113":1132434,"114":0,"115":0,"116":45000}}}
```

The JSON character string needs to be converted to an object first before it can be data can be processed in a Java script. For example, when the JSON character string contains the variable "tdata" the conversation looks like this:

```
var LiveDaten=JSON.parse(tdata)[801][170];
```

After that the individual data fields can be accessed via the indexes specified in the following table.

For example, the current P_{AC} output is displayed as follows:

```
alert(„The current AC output is: „ + LiveDaten[101] + „ W“);
```

JSON Objects

Data point	Value range	Unit	Index	Description
lastUpdateTime	DWORD	Time in the format dd.mm.yy; hh.minmin, secsec	100	Time
Pac	DWORD	W	101	Total output PAC from all of the inverters and meters in inverter mode
Pdc	DWORD	W	102	Total output PAC from all of the inverters
Uac	WORD	V	103	Average voltage UAC from the inverter
DC voltage:	WORD	V	104	Average voltage UDC from the inverter
yieldDay	DWORD	Wh	105	Total yield for the day from all of the inverters
yieldYesterday	DWORD	Wh	106	Total yield for the previous day from all of the inverters
yieldMonth	DWORD	Wh	107	Total yield for the month from all of the inverters
yieldYear	DWORD	Wh	108	Total yield for the year from all of the inverters
yieldTotal	DWORD	Wh	109	Total yield from all of the inverters
consPac	DWORD	W	110	Current total consumption PAC from all of the consumption meters
consYieldDay	DWORD	Wh	111	Total consumption from all of the consumption meters
consYieldYesterday	DWORD	Wh	112	Total consumption for the previous day; all of the consumption meters
consYieldMonth	DWORD	Wh	113	Total consumption for the month; all of the consumption meters
consYieldYear	DWORD	Wh	114	Total consumption for the year; all of the consumption meters
consYieldTotal	DWORD	Wh	115	Accumulated total consumption, all Consumption meter
totalPower	DWORD	Wp	116	Installed generator power

20 Dimensions

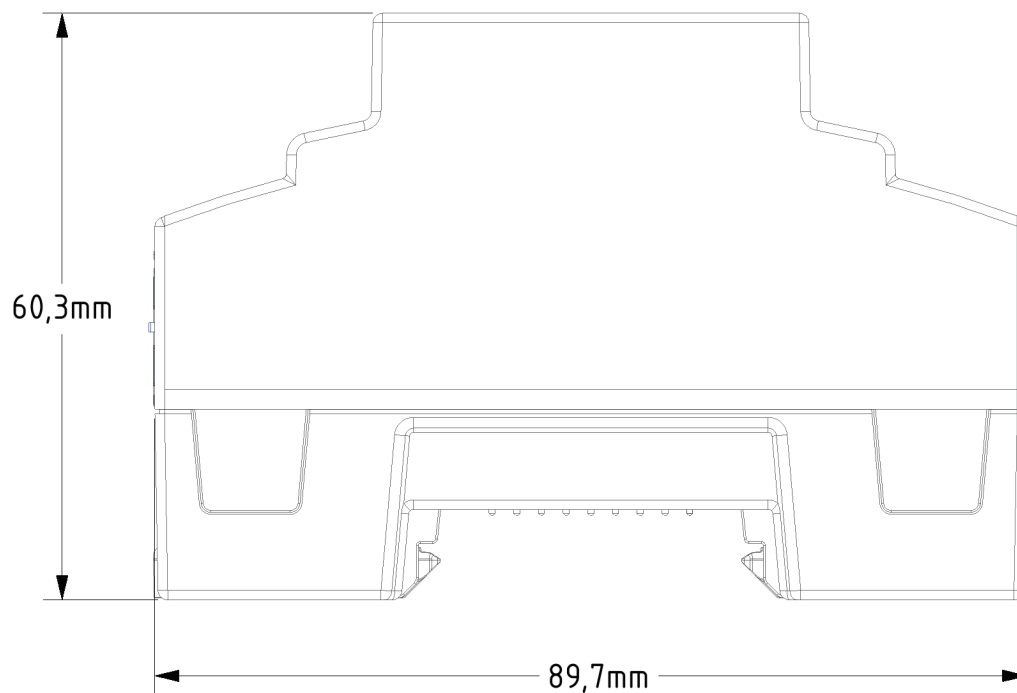
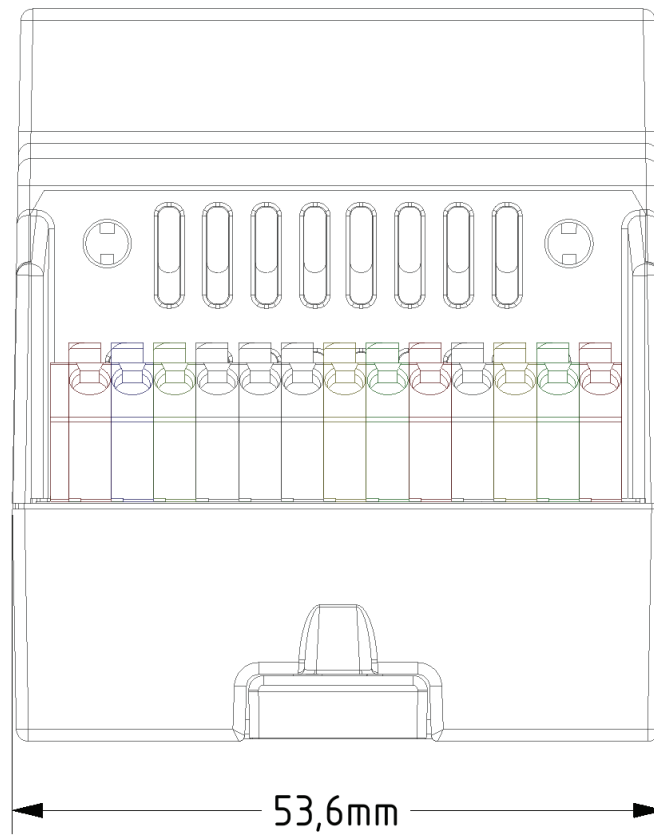

21 List of Figures

Fig.: Solar-Log Base without extended snap-fit tabs	Fig.: Solar-Log Base with extended snap-fit tabs	11
Fig.: Solar-Log Base connections - 2 x RS485 (A and B) or 1 x RS422 - colored PIN connection on the device		12
Fig.: Bottom Connections Solar-Log Base		14
Fig.: Mounting information for the Sensor Box Professional Plus		21
Fig.: Utility Meter connection diagram for voltage measurements in low-voltage power grids		29
Fig.: Utility Meter connection diagram for voltage measurements with current transformers (medium voltage)		29
Fig.: Utility Meter connection diagram for current measurements with current transformers		30
Fig.: Smart Relay Box relay output (change-over contact) diagram		33
Fig.: Smart Relay Box relay output (make contact) diagram		33
Fig.: Main menu of the Solar-Log Base 2000		40
Fig.: Pop-up window with security information		41
Fig.: Configuration page "Access control"		42
Fig.: Structure of the Solar-Log Base's Main Menu		43
Fig.: Control elements		44
Fig.: Log in button with selection box		46
Fig.: System Info with example plant		47
Fig.: Header bar with the "Hide Arrow"		48
Fig.: Signal for new firmware		48
Fig.: Automatic Firmware Update Check with notification text displayed		49
Fig.: Info symbol with activate Installation mode		50
Fig.: Red triangle with information text		50
Fig.: "Licenses" menu with the "Required Licenses" section (example)		51
Fig.: Login symbol with selected assistant		52
Fig.: Startup screen of the Solar-Log™ configuration wizard		52
Fig.: Solar-Log™ Ethernet settings from the Solar-Log™ Configuration Wizard		54
Fig.: Example of a successful connection test		56
Fig.: Example of an unsuccessful connection test		56
Fig.: Displayed Firmware Update Window		57
Fig.: Configuration wizard - Example - Interface Assignments		57
Fig.: Example - Configuration Wizard - Device Configuration		58
Fig.: Example - Configuration Wizard Summary		59
Fig.: VLCD Display		61
Fig.: Virtual LCD Display - Meaning of the symbols		62
Fig.: Example for a blinking code sequence for Internet - Fault 4		63
Fig.: Ethernet settings for the first Ethernet interface		65
Fig.: Example of a successful connection test		66
Fig.: Example of an unsuccessful connection test		66
Fig.: Proxy settings		68
Fig.: Example - Transfer Test with an Error Image		70
Fig.: Example - Connection Test with an Error		70
Fig.: Interface definition via the plus symbol		72
Fig.: Adding components		72
Fig.: Overview of the selected components		73
Fig.: Device detection - not started yet		74
Fig.: Selecting switch for Smart Energy		87
Fig.: Example - Creating switching groups		90
Fig.: Adjustable switch with help text		92
Fig.: Control logic configuration window		93
Fig.: Example - Surplus management		101
Fig.: Schematic diagram of a ripple control receiver with four relays		107
Fig.: Channel settings for power reduction		108
Fig.: Q(U) control function diagram example		117
Fig.: Schematic diagram of a ripple control receiver with four relays		120
Fig.: Channel settings for remote controlled cos (Phi)		120
Fig.: Switching to reactive power characteristic curves with certain signals		121
Fig.: Solar-Log™ network configuration		122
Fig.: Activated PM+ Profile for a PM Package		123
Fig.: Modbus TCP PM activated		124
Fig.: Direct marketing with imported example package		125
Fig.: Configuring the time on the Solar-Log™		134
Fig.: Solar-Log™ with license section		136
Fig.: Inverter details graph		140
Fig.: Tracker comparison graph		141
Fig.: Module field comparison graph		142
Fig.: Example of a plant with an energy flow		195

Fig.: Battery diagnosis - Current measurement values	143
Fig.: Battery diagnosis - Charging History 1-Day	144
Fig.: Battery diagnosis - Balance.....	146
Fig.: The event log is being loaded.....	147
Fig.: Event log.....	147
Fig.: Feed-In Management - Control State	149
Fig.: Feed-In Management - Feed-balance	156
Fig.: PM History	157
Fig.: RS485 bus analysis with Janitza as an example (with installation mode active)	158
Fig.: Example segment section of the enlarged measured value range	159
Fig.: Example segment section of the lower measured value range.....	159
Fig.: Components - S0 meter on interface A and B	160
Fig.: Connection test - Wireless Package.....	161
Fig.: Example of the SCB string overview	162
Fig.: Smart Energy Status (current)	164
Fig.: Smart Energy History - Example of Priority 1	165
Fig.: Smart Energy - Simulation with EGO - Surplus Priority 1	167
Fig.: Support - General.....	169
Fig.: The plant's current values (cockpit view)	170
Fig.: Example of a plant with an energy flow.....	172
Fig.: Table with the recorded output from an example plant	173
Fig.: Graphic display of the plant's total production.....	174
Fig.: Daily View of the Production Graph with the Auto Scaling activated.....	175
Fig.: Day view of the production table.....	176
Fig.: Month view production graph.....	177
Fig.: Month view of the production table.....	178
Fig.: Year view graph.....	179
Fig.: Total view graph.....	180
Fig.: Graph of daily consumption with connected appliances in the sub-consumer view	184
Fig.: Graph of daily consumption with connected appliances and active line graphics in the sub-consumer view.....	185
Fig.: Day Balance graph with battery system	188
Fig.: Daily Balance Graph with the Auto Scaling activated.....	189
Fig.: Month view balance graph	190
Fig.: Year view balance graph	191
Fig.: Total balance graph	192
Fig.: Graph of Sensor Box values	193

Solare Datensysteme GmbH
Fuhrmannstraße 9
72351 Geislingen-Binsdorf
Germany
Tel: +49 7428 9418 200
Fax: +49 7428 9418 280
info@solar-log.com
www.solar-log.com
www.solarlog-web.com

The copyright of these instructions remains with the manufacturer. No part of these instructions may be reproduced in any form or processed, duplicated or distributed using electronic systems without the written consent of Solare Datensysteme GmbH.

Non-compliance resulting in contradiction of the above-mentioned specifications shall result in obligation to provide compensation for damages.

Subject to change without notice.

Solare Datensysteme GmbH cannot guarantee the accuracy or completeness of the information provided and expressly refuses to accept liability for any errors or omissions in such information.

All brands and trademarks contained in this manual are the sole property of the respective manufacturer, which we respect and recognize herewith. In many countries, the designation "Speedwire" is a registered trademark of SMA Solar Technology AG.

SDS assumes no liability for printing errors.