

INSTALLATIONSANLEITUNG

DE

Batterie-Absicherung "Master Unit" Typ 10011700

für das PV-Energiespeichersystem

der



3 x



Sunny Island (alle Typen)

Sollte ein anderer Batterielader/Inverter für den Einsatz vorgesehen sein, so muss die Eignung der verwendeten Schutzschalter (Nennwert, Auslösecharakteristik) von der Fa. Axitec Energy bestätigt werden.

6 x Energiespeicher "AXIstorage Li 7S"

bzw.

6 x Energiespeicher "AXIstorage Li 9S"



INHALTSVERZEICHNIS

1. Verwendung und Sicherheitshinweis.....	3
2. Lieferumfang.....	4
3. Montage "Master Unit"	5
3.1 Anforderungen an den Montageort.....	5
3.2 Mindestabstände/Abmessungen/Befestigung	6
4. Elektrischer Anschluss	7
5. Wartung.....	8
6. Lagerung.....	8
7. Entsorgung.....	8
8. Spezifikation.....	9
8.1 Auslösecharakteristik	9
8.2 Technische Daten "Master Unit" Typ 10011700.....	10

1. Verwendung und Sicherheitshinweis

Die Baureihe der Batterieabsicherung vom Typ "Master Unit" wurde entwickelt, um mobile und stationäre Batteriespeicher verschiedener Technologien (Blei, Lithium...) vor Überstrom und Kurzschluss zu schützen. Die Spannungsgrenzen für den Gleichstrombetrieb sind hierbei 75V DC für die Systemspannung. Die speziell für den Einsatz im Energiespeichersystem "AXIstorage Li 7S" abgestimmten Nennwerte der verwendeten Schutzschalter bieten ein Optimum an Zuverlässigkeit und Verfügbarkeit.

Falls die Leistungsschalter auslösen, liegt ein Fehler im Batteriesystem vor. Stellen Sie also vor der Wiederschaltung die Fehlerfreiheit sicher!

Die "Master Unit" soll immer in unmittelbarer Nähe des Batteriespeichers montiert werden, um für diesen einen hinreichenden Schutz darzustellen.

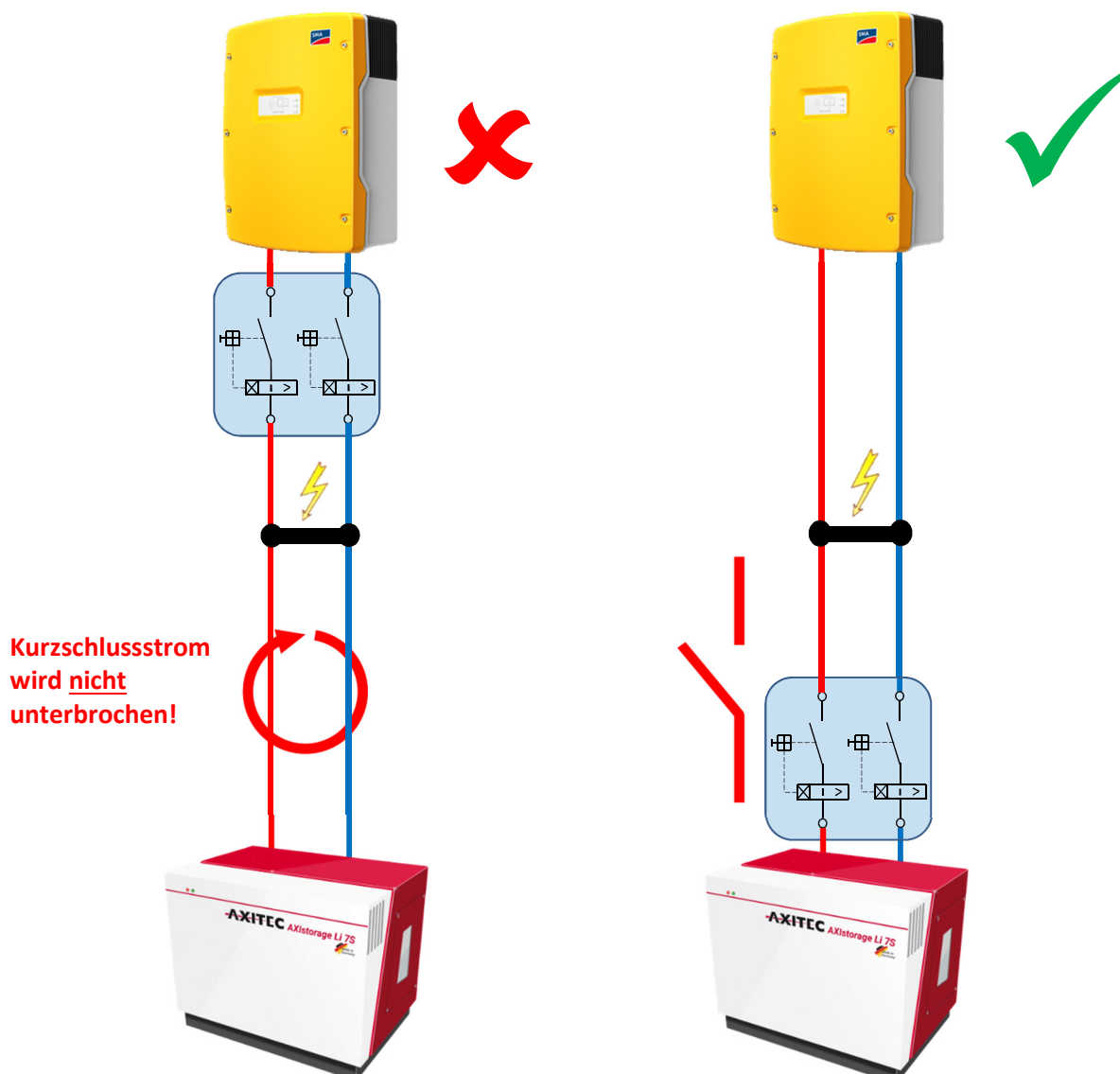

2. Lieferumfang

A



B



C



D



E



Position	Anzahl	Bezeichnung
A	1	Master Unit Typ 10011700
B	6	Verschraubung M32 x 1,5 (Klemmbereich Ø15-25mm)
C	12	Verschraubung M32 x 1,5 (Klemmbereich Ø13-21mm)
D	4	Würgenippel M32 x 1,5
E	18	Gegenmutter M32

3. Montage "Master Unit"

3.1 Anforderungen an den Montageort



GEFAHR

Lebensgefahr durch Feuer und Explosion

- Master Unit nicht auf brennbaren Baustoffen montieren!
- Master Unit nicht in Bereichen montieren, in denen sich leicht entflammable Baustoffe befinden!
- Master Unit nicht in explosionsgefährdeten Bereichen montieren!

- Untergrund besteht aus festem Material
- Untergrund eignet sich für Gewicht und Abmessungen
- Montageort ist jederzeit zugänglich
- Klimatische Bedingungen sind eingehalten (s. technische Daten)
- Montageort ist keiner direkten Sonneneinstrahlung und keiner direkten Bewitterung ausgesetzt
- Montageort ist vor Spritzwasser geschützt

Montageposition

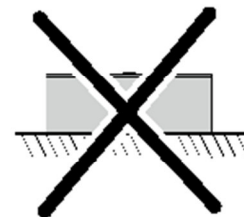

3.2 Mindestabstände/Abmessungen/Befestigung

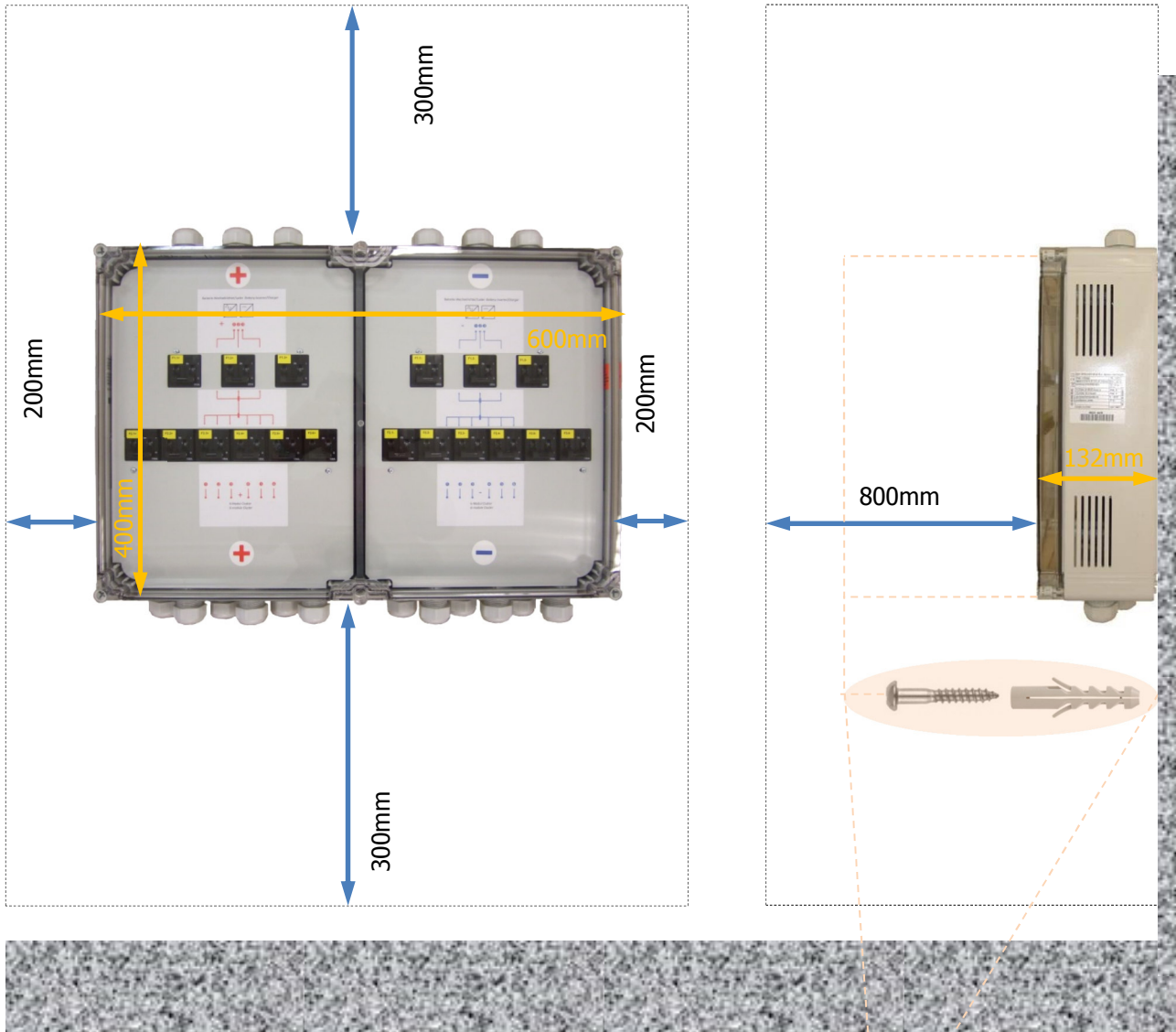

Wählen Sie **je nach Untergrund** eine passende Befestigungsart, **z.B.** mittels 4 x Spreizdübel S8 und 4 x Spanplatten/Holzschraube 5.0

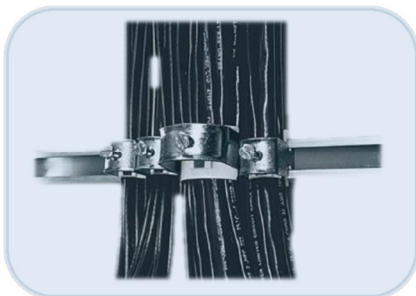

Kabelabfang nicht vergessen!

ACHTUNG: Max. Durchmesser Schraubenkopf: 10mm!

4. Elektrischer Anschluss



Abdeckungen entfernen!



M32 Ø15-25mm **O BEN**



M32 Ø13-21mm **UN TEN**



O BEN: max. 3 x Lader/Inverter

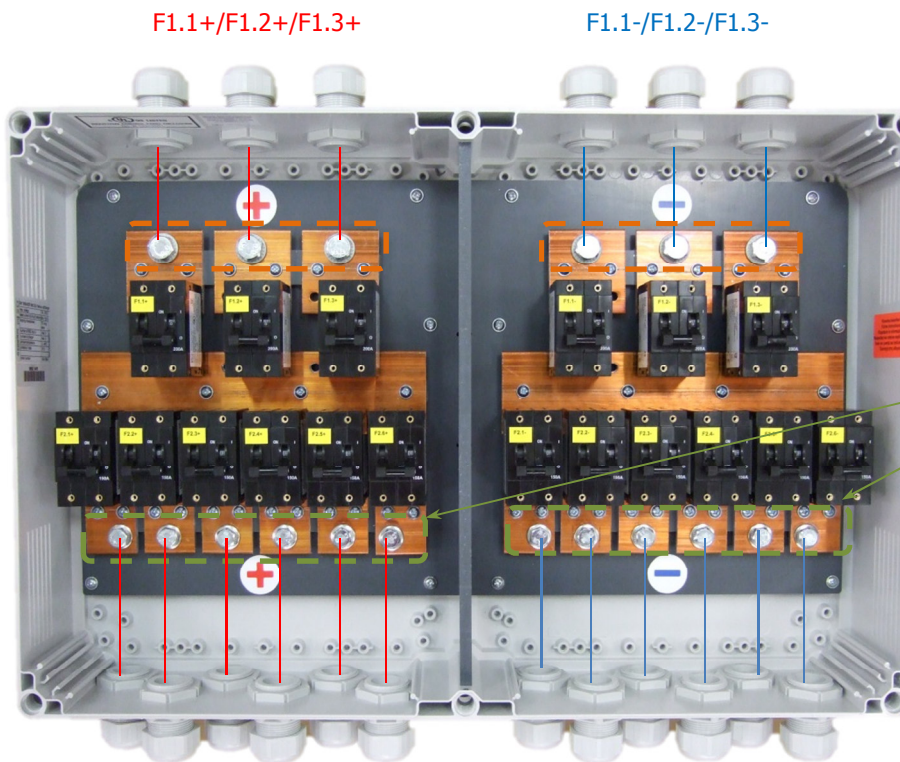

- ↳ Kabelschuhe M10
- ↳ Max. Cu-Querschnitt: 95mm²
- ↳ Anzugsdrehmoment: 23-28Nm



keine Englaschenrohrkabelschuhe verwenden!



- ↳ Kabelschuhe M8
- ↳ Max. Cu-Querschnitt: 50mm²
- ↳ Anzugsdrehmoment: 13-18Nm



UN TEN: 6 x Energiespeicher "AXIstorage Li 7S"
 bzw.
 6 x Energiespeicher "AXIstorage Li 9S"

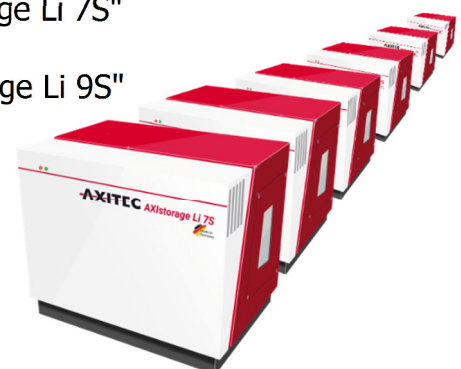

5. Wartung

Sie sollten die Batterieabsicherung "Master Unit" regelmäßig auf Funktion und Sicherheit überprüfen. Nach BGV A3 §5 sind z.B. elektrische Anlagen und ortsfeste elektrische Betriebsmittel in „Betriebsstätten, Räumen und Anlagen besonderer Art“ (DIN VDE 0100-712 für PV-Anlagen) EINMAL im Jahr durch eine Elektrofachkraft zu überprüfen!

Optische Prüfung

Abhängig vom Aufstellungsort und den Umgebungsbedingungen findet eine mehr oder weniger starke, äußere Verschmutzung statt. Reinigen Sie hier vorsichtig mit einem feuchten Reinigungstuch! Öffnen Sie hierzu nicht das Gehäuse!

6. Lagerung

Anforderungen an den Lagerort:

- Ort ist trocken
- Umgebungstemperatur liegt zwischen -25°C und +55°C
- Bei Lagerung bis maximal 24 Stunden darf die Umgebungstemperatur max. +70°C betragen!

7. Entsorgung

Entsorgen Sie die Batterieabsicherung "Master Unit" nach den aktuell geltenden Entsorgungsregeln für Elektronikschrott!

8. Spezifikation

8.1 Auslösecharakteristik

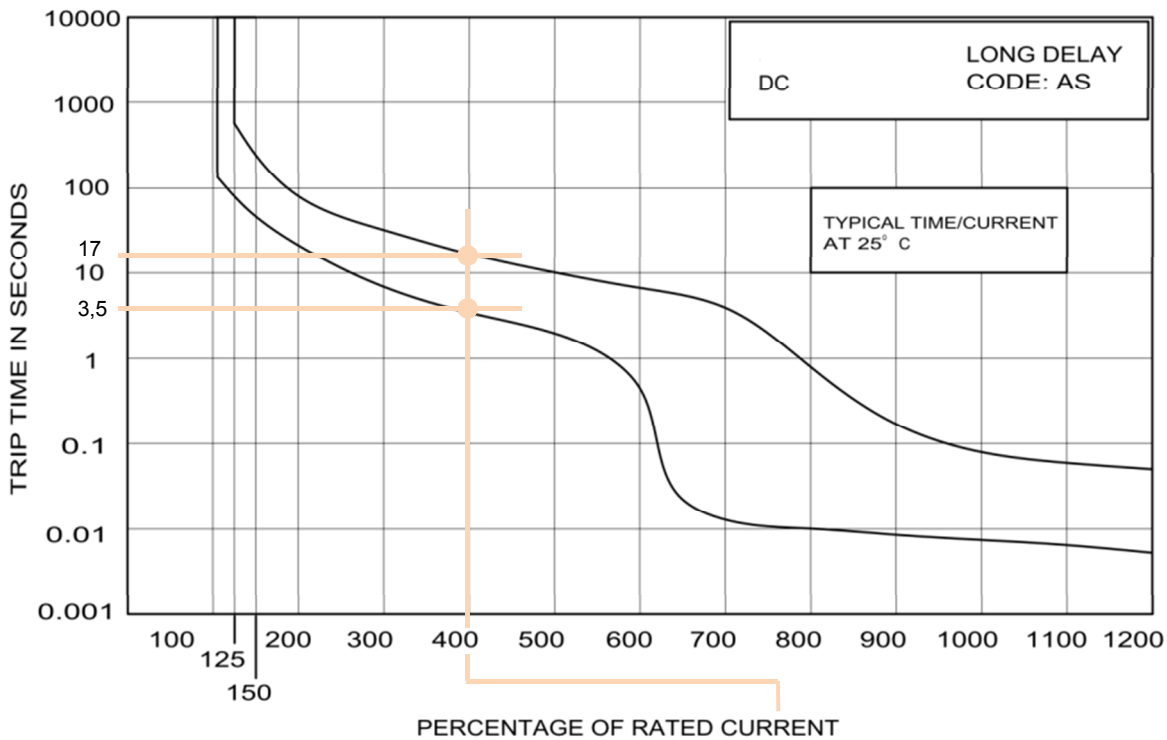

PERCENTAGE OF RATED CURRENT	100%	125%	200%	400%	600%	800%	1000%	1200%
MINIMUM TRIP TIME IN SECONDS	NO TRIP	80	21	3.5	0.45	0.01	0.0075	0.005
MAXIMUM TRIP TIME IN SECONDS	NO TRIP	560	80	17	6.8	0.8	0.08	0.05

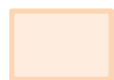

Beispiel:

Schutzschalter mit Nennwert 200A:
 Fehlerstrom von 800A (= 400% von Nennstrom 200A)
 Auslösezeit zwischen 3.5s und 17s
 (logarithmischer Maßstab für die Auslösezeit in [s])

8.2 Technische Daten "Master Unit" Typ 10011700

Artikel-Nr.	10011700
Bezeichnung (Match-Code)	Master Unit-Spec. Axitec-EU -6x Accu -3x Charger
Elektrische Daten	
Anzahl Batterielader/Batteriewechselrichter	max. 3
Freigegebene Typen	SMA - Sunny Island (alle Typen)
Anzahl Akku-Parallelstränge	min. 4/max. 6
Max. DC-Spannung	75V
Nennstrom Schutzschalter für Lader	200A pro Potenzial
Nennstrom Schutzschalter für Akku	150A pro Potenzial
max. Betriebsströme	kompatibel zu "AXIstorage Li"-System
Auslösecharakteristik	DC - "träge" - siehe Kennlinie
schaltbarer max. Kurzschlussstrom	10kA
Anschlüsse (vorbereitet für Kabelschuhe)	
<i>Vom Lader/Wechselrichter</i>	
Kabelschuh	1 x M10 pro Potenzial
max. Cu-Querschnitt	
* Kabelschuhe passen durch Verschraubung (vorkonfektioniert)	50...70mm ²
* Kabelschuhe werden nach Durchführung der Cu-Litze gepresst	95mm ²
<i>Zum Akku (6 x)</i>	
Kabelschuh (ACHTUNG: Kein Englaschenrohrkabelschuh!)	1 x M8 pro Potenzial
max. Cu-Querschnitt	50mm ²
Gehäuse	
Schutzart	IP31
Schutzklasse	II
Abmessungen (BxHxT)	600x400x132(mm) ohne Verschraubungen
Material	Polycarbonat - Unterteil RAL7035; Oberteil transparent
Montageart	Wandmontage
Leitungseinführungen	durchgehend Verschraubung M32
Umgebungsbedingungen für Betrieb	
relative Luftfeuchtigkeit	bis 85%, nicht kondensierend
Betriebs-Temperaturbereich	0°...45°C
Sonstiges	
Gewicht	ca. 14,5 Kg

AXITEC Energy GmbH & Co.KG
 Otto-Lilienthal-Straße 5
 71034 Böblingen
 Deutschland
 Telefon +49 (0)7031 6288-5186
 Telefax +49 (0)7031 6288-5187
energy@axitecsolar.com

INSTALLATION MANUAL

EN

Battery-protection "Master Unit" type 10011700

suitable for the PV energy storage system



3 x  Sunny Island (all types)

If a different battery inverter/charger is aimed to use: Please clarify the technical capability in accordance with Axitec Energy who keeps the responsibility for the system!

power storage system:

6 x "AXIstorage Li 7S"

respectively

6 x "AXIstorage Li 9S"



TABLE OF CONTENTS

1. Scope of application and appropriate usage.....	3
2. Scope of delivery	4
3. Mounting the "Master Unit"	5
3.1 Selecting the mounting location.....	5
3.2 Minimum distances/dimension/mounting method	6
4. Electrical connecting	7
5. Maintenance and cleaning	8
6. How to stock the "Master Unit"	8
7. Disposal.....	8
8. Specification in detail	9
8.1 Tripping characteristic	9
8.2 Technical data "Master Unit" type 10011700.....	10

1. Scope of application and appropriate usage

You may use the battery-protection series "Master Unit" in general for stationary or even mobile battery storage systems within different technologies (Lead, Lithium...) as a protection against overcurrent and short-circuit current. The voltage for charging/discharging is limited to max. 75V DC. The circuit breaker's nominal current-values are matching the Axitec Energy GmbH Systems requirements and making the maximum safety and availability for the system feasible.

If you observe a releasing of circuit breakers there must be a failure in the system! Before switching on again the circuit breaker you have to ensure the system's error-free performance!

The "Master Unit" should be installed in close distance to the energy-storage unit. This provides the best protection for the system and cabling!

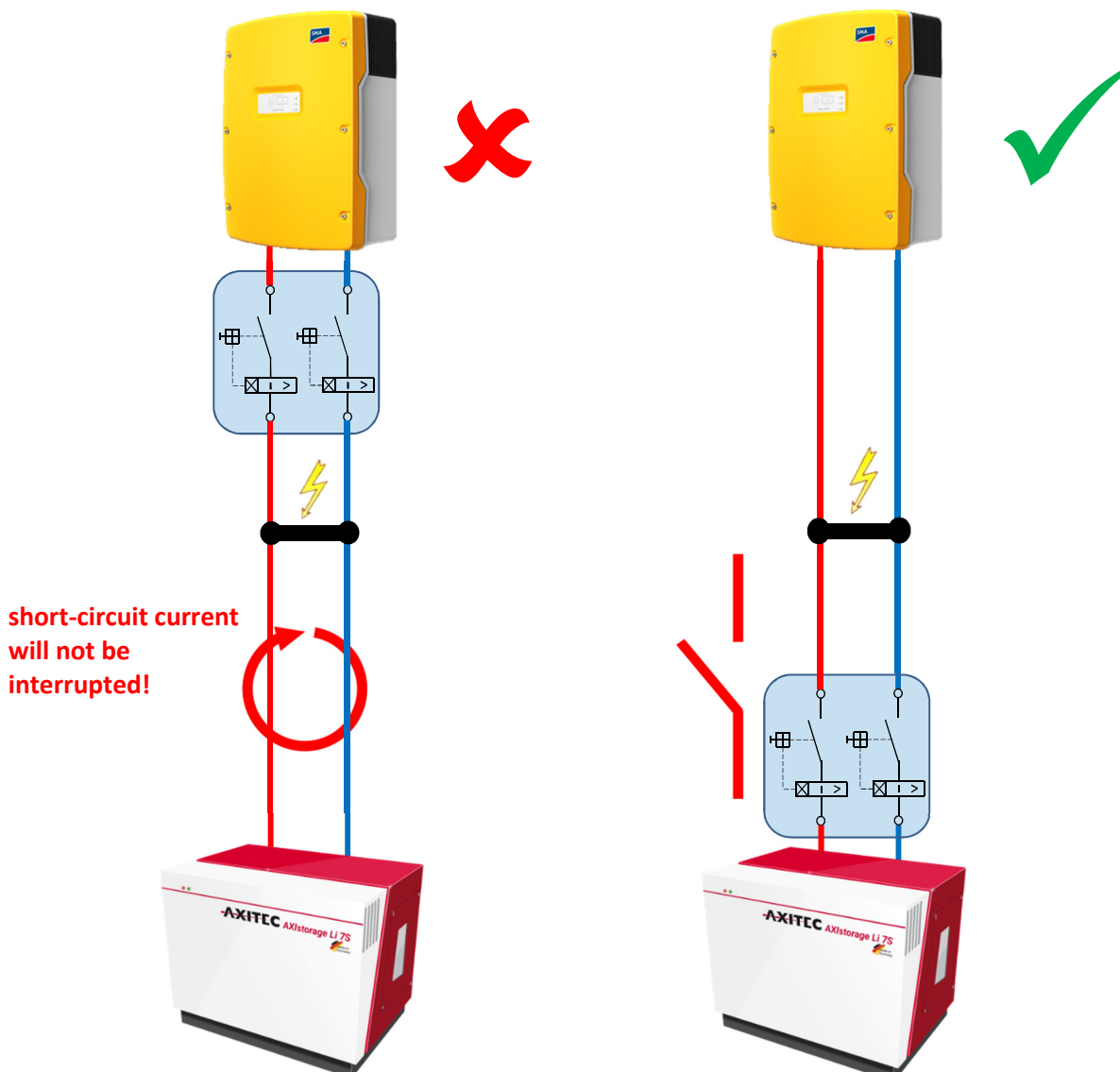

2. Scope of delivery



position	quantity	component
A	1	Master Unit type 10011700
B	6	Cable gland M32 x 1,5 (clamping range Ø 15-25mm)
C	12	Cable gland M32 x 1,5 (clamping range Ø 13-21mm)
D	4	Twisting sleeve (without aperture) M32 x 1,5
E	18	Locknut M32

3. Mounting the "Master Unit"

3.1 Selecting the mounting location



DANGER

risk of explosion or fire

- do not mount the Master Unit on flammable construction materials!
- do not mount the Master Unit near highly flammable materials!
- do not mount the Master Unit in potentially explosive areas!

- mount on a solid surface
- the mounting location and method must be suitable for the weight and dimension
- the mounting location must be accessible at all times
- climatic conditions must be in compliance with the specification
- the device may not be exposed to direct sunlight and weather
- the mounting location has to be protected against splashing water

installation position

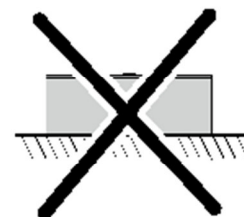

3.2 Minimum distances/dimension/mounting method

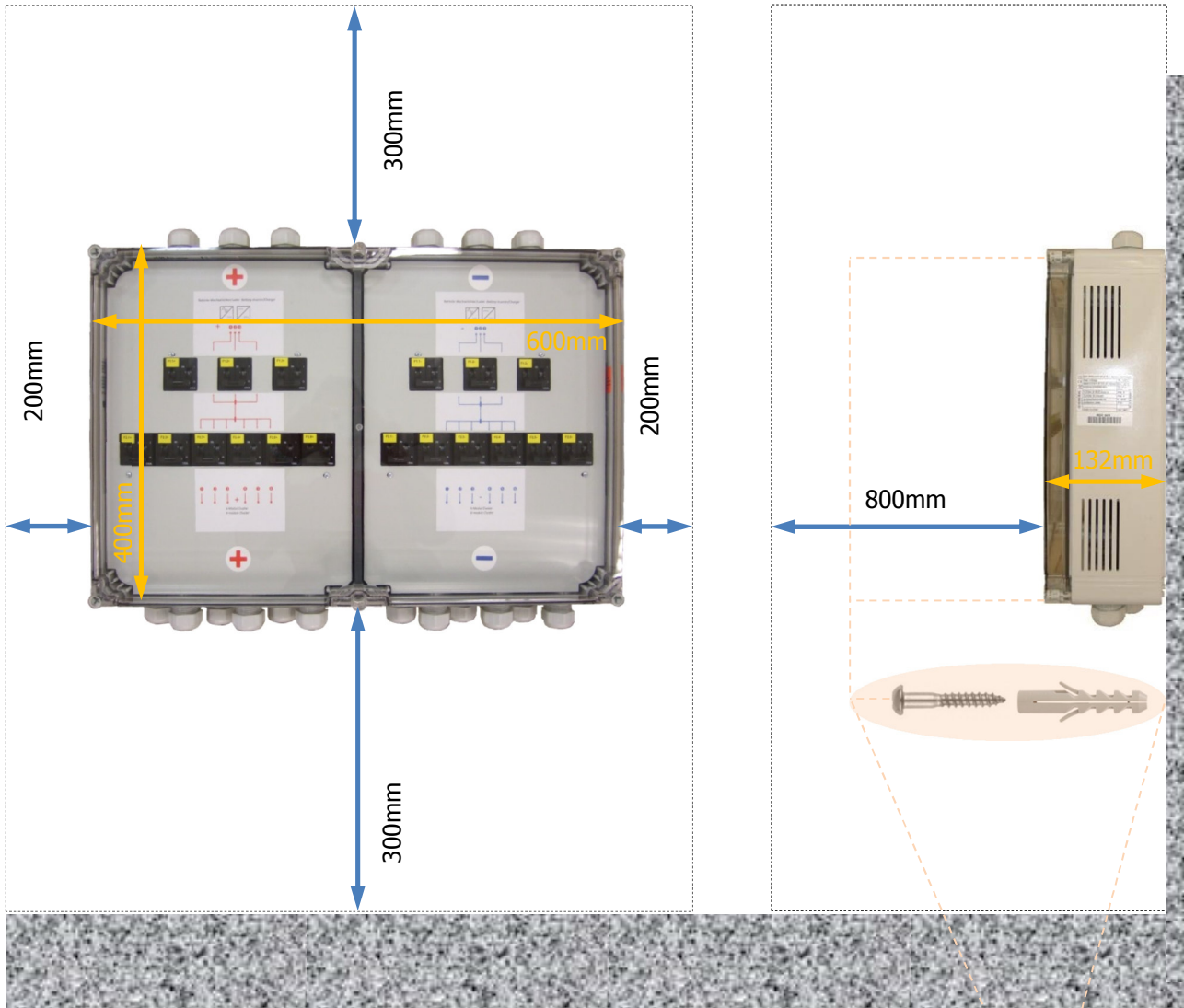

Select the correct mode of mounting, **depending on the mounting surface**, for example 4 x expansion anchor "S8"+ 4 x chipboard screw Ø5.0

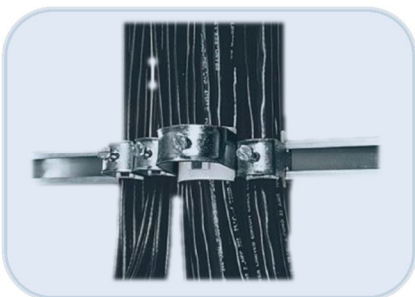

Do not forget the cable catch rail!

ATTENTION: Max. diameter head of bolt: Ø10mm!

4. Electrical connecting

 previously remove the cover!

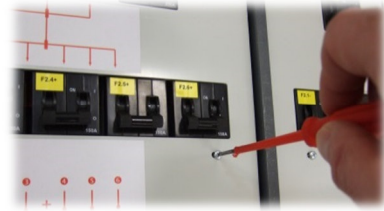



  **M32** Ø15-25mm TOP

  **M32** Ø13-21mm BOTTOM

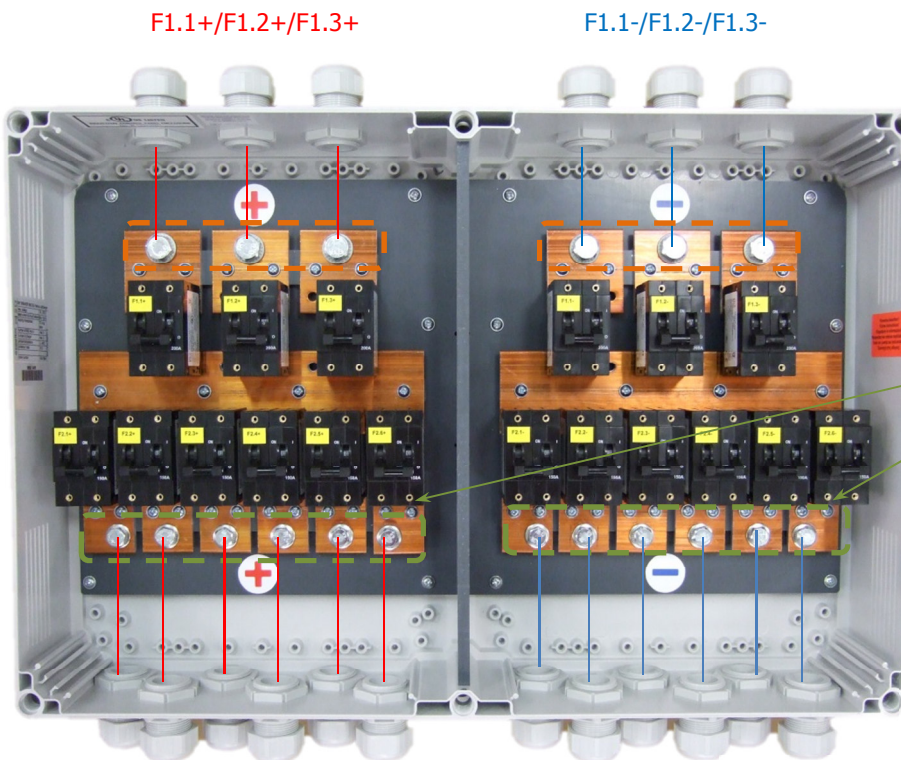

 **TOP:** max. 3 x charger/inverter



-  cable lug M10
-  max. cross section (litz wire): 95mm²
-  range of tightening torque: 23-28Nm



do not use the narrow flange cable lugs for switch gear connections!

-  cable lug M8
-  max. cross section (litz wire): 50mm²
-  range of tightening torque: 13-18Nm

F2.1+/F2.2+/F2.3+/F2.4+/F2.5+/F2.6+ F2.1-/F2.2-/F2.3-/F2.4-/F2.5-/F2.6-

 **BOTTOM:** 6 x "AXIstorage Li 7S" respectively 6 x "AXIstorage Li 9S"



5. Maintenance and cleaning

You should do a frequent short inspection of your "Master Unit" for keeping a long durability and avoidance of an operational system's breakdown.

Please also consider your national standards and provisions regarding the requirements of battery- and/or PV power installations and their equipment. Potentially, you have to do an electrical test procedure once a year as it is to adduce in some european countries, e.g. Germany.

Visual inspection

Depending on the installation side and the environmental conditions you have to expect some pollution on the device's surface. Clean carefully with the help of a moist cloth! During this time do not open the case of the device under any circumstances!

6. How to stock the "Master Unit"

Demands:

- dry conditions
- ambient air temperature ranges from -25°C up to +55°C
- for a maximum of 24 hours: temperature might get higher up to +70°C

7. Disposal

Disposal is due to your national/local regulations. The "Master Unit" is to classify as "electronic waste" (it is no "household waste"!).

Take care of that and protect the environment!

8. Specification in detail

8.1 Tripping characteristic

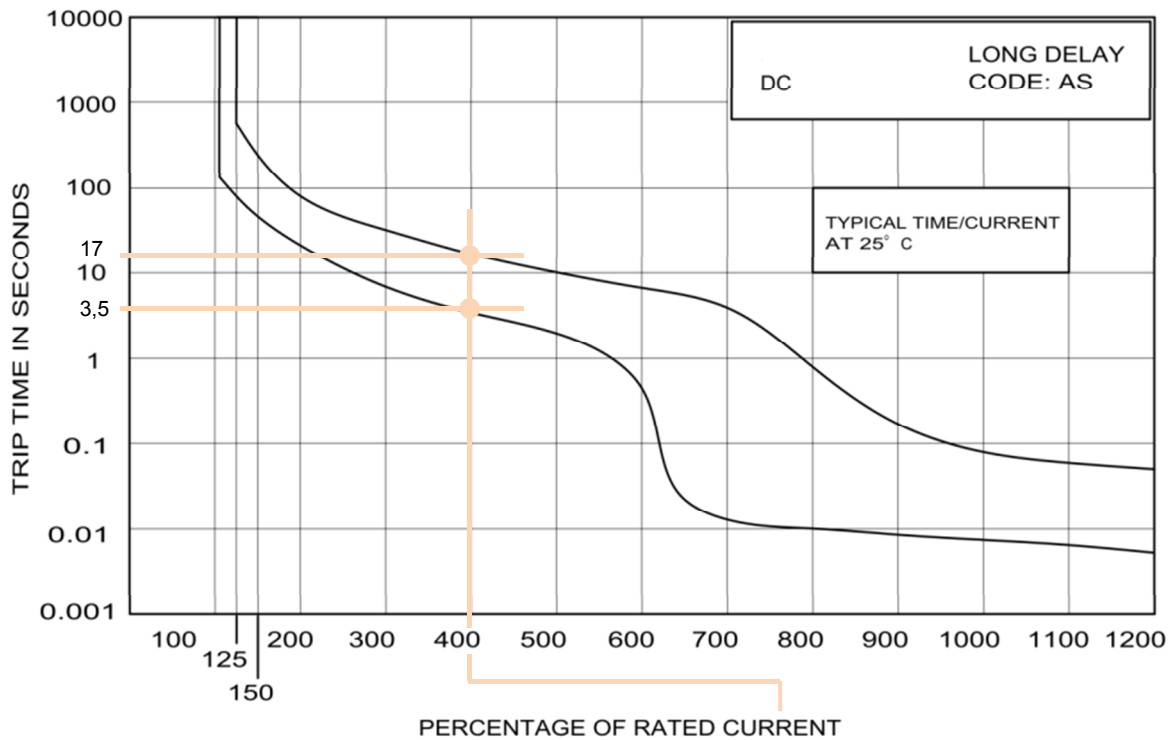

PERCENTAGE OF RATED CURRENT	100%	125%	200%	400%	600%	800%	1000%	1200%
MINIMUM TRIP TIME IN SECONDS	NO TRIP	80	21	3.5	0.45	0.01	0.0075	0.005
MAXIMUM TRIP TIME IN SECONDS	NO TRIP	560	80	17	6.8	0.8	0.08	0.05



for example: circuit breaker - rated current 200A:
 overcurrent of 800A (= 400% of rated current 200A)
 trip time between 3.5s und 17s
 (axis of ordinates: log. scale - trip time [s])

8.2 Technical data "Master Unit" type 10011700

order number	10011700
designation (match-code)	Master Unit-Spec. Axitec-EU -6x Accu -3x Charger
electrical data	
max.number of battery charger/inverter	max. 3
confirmed manufacturer and device-type	SMA - Sunny Island (all types)
max.number of accu parallel-connect	min. 4/max. 6
max. DC-voltage	75V
rated current of circuit breaker -charger/inverter-	200A per potential
rated current of circuit breaker -power storage Li 7S/9S	150A per potential
max. permitted occurring current	compatible to "AXIstorage Li" system
tripping characteristic	DC - "long delay" - CBI Circuit Breaker
max. short circuit breaking capacity	10kA
electrical connection (ready for cable-lugs)	
<i>towards - charger/inverter</i>	
cable lug	1 x M10 per potential
max. cross section of litz wire	
* cable lug fits through the opening of the cable glands (cable lug is already pre-crimped)	50...70mm ²
* cable lug must be crimped after inserting the litz wire	95mm ²
<i>towards - accu (6 x)</i>	
cable-lug (caution: Do not use the cable-lugs with narrow flange for switch gear connections!)	1 x M8 per potential
max. cross section of litz wire	50mm ²
cabinet	
IP protection class	IP31
protection class against electric shock	II
dimensions (WxHxD)	600x400x132(mm) - without cable glands-
plastic material	polycarbonate - base part in grey -RAL7035-; cover clear
installation type	wall mounting
cable inlets (plastic metric cable glands)	M32 (all)
environmental conditions for operation	
humidity	up to 85%, non-condensing
ambient temperature range	0°...45°C
miscellaneous	
weight	approx. 14,5 Kg

AXITEC Energy GmbH & Co.KG
 Otto-Lilienthal-Straße 5
 71034 Böblingen, Germany
 Phone: +49 (0)7031 6288-5186
 Fax: +49 (0)7031 6288-5187
energy@axitecsolar.com