

1-phase Hybrid Inverter

User Manual

SH3.0RS/SH3.6RS/SH4.0RS/SH5.0RS/SH6.0RS



All Rights Reserved

All Rights Reserved

No part of this document can be reproduced in any form or by any means without the prior written permission of Sungrow Power Supply Co., Ltd (hereinafter "SUNGROW").

Trademarks

SUNGROW and other Sungrow trademarks used in this manual are owned by SUNGROW.

All other trademarks or registered trademarks mentioned in this manual are owned by their respective owners.

Software Licenses

- It is prohibited to use data contained in firmware or software developed by SUNGROW, in part or in full, for commercial purposes by any means.
- It is prohibited to perform reverse engineering, cracking, or any other operations that compromise the original program design of the software developed by SUNGROW.

About This Manual

The manual mainly contains the product information, as well as guidelines for installation, operation and maintenance. The manual does not include complete information about the photovoltaic (PV) system. The reader can get additional information about other devices at www.sungrowpower.com or on the webpage of the respective component manufacturer.

Validity

This manual is valid for the following inverter models:

- SH3.0RS
- SH3.6RS
- SH4.0RS
- SH5.0RS
- SH6.0RS

They will be referred to as "inverter" hereinafter unless otherwise specified.

Target Group

This manual is intended for inverter owners who will have the ability to interact with the inverter and qualified personnel who are responsible for the installation and commissioning of the inverter. Qualified personnel should have the following skills:

- Training for installation and commissioning of electrical system, as well as dealing with hazards
- Knowledge of the manual and other related documents
- Knowledge of the local regulations and directives

How to Use This Manual

Read the manual and other related documents before performing any work on the inverter. Documents must be stored carefully and be available at all times.

Contents may be periodically updated or revised due to the product development. The manual content of subsequent versions of the inverter may be subject to change. The latest manual can be found at support.sungrowpower.com.

Symbols

Important instructions contained in this manual should be followed during installation, operation and maintenance of the inverter. They will be highlighted by the following symbols.

 **DANGER**

Indicates a hazard with a high level of risk that, if not avoided, will result in death or serious injury.

 **WARNING**

Indicates a hazard with a medium level of risk that, if not avoided, could result in death or serious injury.

 **CAUTION**

Indicates a hazard with a low level of risk that, if not avoided, could result in minor or moderate injury.

NOTICE

Indicates a situation that, if not avoided, could result in equipment or property damage.



Indicates additional information, emphasized contents or tips that may be helpful, e.g. to help you solve problems or save time.

Contents

All Rights Reserved	I
About This Manual	II
1 Safety	1
1.1 PV Panels	1
1.2 Utility Grid	1
1.3 Inverter	2
1.4 Batteries	3
2 Product Description	4
2.1 System Introduction	4
2.2 Product Introduction	4
2.3 Symbols on the Product	6
2.4 LED Panel	7
2.5 DC Switch	8
2.6 PV Energy Storage System (PV ESS)	8
2.6.1 PV Energy Storage System (PV ESS)	8
2.6.2 Declaration For Back-Up Function	10
2.7 Retrofitting the Existing PV System	10
3 Function Description	13
3.1 Safety Function	13
3.1.1 Protection	13
3.1.2 Ground Fault Alarm	13
3.2 Energy Conversion and Management	13
3.2.1 Power Derating	13
3.2.2 DRM ("AU"/"NZ")	14
3.2.3 Regular Operational Voltage Range	14
3.2.4 Regular Operational Frequency Range	15
3.2.5 Reactive Power Regulation	15
3.3 Battery Management	15
3.3.1 Charge Management	16
3.3.2 Discharge Management	17
3.4 PID Recovery Function	18

3.5	Communication and Configuration	18
3.6	Import Power Limit Function	18
4	Unpacking and Storage	20
4.1	Unpacking and Inspection	20
4.2	Inverter Storage	20
5	Mechanical Mounting	21
5.1	Safety during Mounting	21
5.2	Location Requirements	21
5.2.1	Environment Requirements.....	22
5.2.2	Carrier Requirements	22
5.2.3	Angle Requirements.....	22
5.2.4	Clearance Requirements	23
5.3	Installation Tools.....	24
5.4	Moving the Inverter	25
5.5	Installing the Inverter.....	26
6	Electrical Connection	28
6.1	Safety Instructions.....	28
6.2	Terminal Description	28
6.3	Electrical Connection Overview	30
6.4	Backup Wiring Diagram	31
6.5	Additional Grounding Connection.....	35
6.5.1	Additional Grounding Requirements	35
6.5.2	Connection Procedure.....	35
6.6	AC Cable Connection	36
6.6.1	AC Side Requirements	36
6.6.2	Connecting the AC Cable	37
6.7	DC Cable Connection	39
6.7.1	PV Input Configuration	40
6.7.2	Assembling the PV Connectors	41
6.7.3	Installing the PV Connector.....	42
6.8	Emergency Load Connection (Backup)	43
6.9	Battery Connection	46
6.9.1	Connecting the Power Cable.....	46
6.9.2	Connecting the CAN Cable	49
6.9.3	Connecting the Enable Cable.....	49
6.10	WiNet-S Connection	49

6.10.1 Ethernet Communication	50
6.10.2 WLAN Communication	52
6.11 Meter Connection	52
6.12 RS485 Connection.....	55
6.13 DRM Connection	55
7 Commissioning	59
7.1 Inspection before Commissioning	59
7.2 Powering on the System	59
7.3 App Preparation	60
7.4 Creating a Plant.....	60
7.5 Initializing the Device	63
7.6 Configuring the Plant	64
8 iSolarCloud App	67
8.1 Brief Introduction	67
8.2 Installing the App.....	67
8.3 Account Registration.....	68
8.4 Login	69
8.4.1 Requirements	69
8.4.2 Login Procedure	69
8.5 Initial Settings.....	71
8.5.1 Feed-in Limitation	71
8.5.2 Off-grid Mode.....	72
8.6 Function Overview.....	72
8.7 Home	72
8.8 Run Information.....	73
8.9 Records.....	74
8.9.1 Chart.....	74
8.9.2 Fault Alarm Record	75
8.9.3 Event Record.....	76
8.10 More.....	76
8.10.1 System Parameters.....	77
8.10.2 Running Time	78
8.10.3 Regular Parameters	78
8.10.4 Off-grid Parameters.....	79
8.10.5 Active Power Regulation.....	79
8.10.6 Reactive Power Regulation.....	80

8.10.7 Battery Discharge Time	83
8.10.8 Battery Forced Charge Time	83
8.10.9 Communication Parameters	84
8.10.10 Firmware Update	85
8.10.11 Grounding Detection	86
8.10.12 Frequency Shift Power Control	86
8.10.13 Import Power Limit	87
9 System Decommissioning	88
9.1 Decommissioning the Inverter	88
9.1.1 Disconnecting the Inverter	88
9.1.2 Dismantling the Inverter	88
9.1.3 Disposal of the Inverter	88
9.2 Decommissioning the Battery	89
10 Troubleshooting and Maintenance	90
10.1 Troubleshooting	90
10.2 Maintenance	98
10.2.1 Maintenance Notices	98
10.2.2 Routine Maintenance	99
11 Appendix	100
11.1 Technical Data	100
11.2 Quality Assurance	105
11.3 Contact Information	105

1 Safety

The device has been designed and tested strictly according to international safety regulations. Read all safety instructions carefully prior to any work and observe them at all times when working on or with the device.

Incorrect operation or work may cause:

- Injury or death to the operator or a third party;
- Damage to the device and other properties.

All detailed work-related safety warnings and notes are specified at critical points in this manual.



- The safety instructions in this manual cannot cover all the precautions that should be followed. Perform operations considering actual onsite conditions.
- SUNGROW shall not be held liable for any damage caused by violation of the safety instructions in this manual.

1.1 PV Panels

DANGER

PV strings will produce electrical power when exposed to sunlight and can cause a lethal voltage and an electric shock.

- **Always keep in mind that the inverter is dual power supplied. Electrical operators must wear proper personal protective equipment: helmet, insulated footwear, gloves, etc.**
- **Before touching the DC cables, operator must use a measuring device to ensure that the cable is voltage-free.**
- **The operator must follow all warnings on the PV strings and in its manual.**

1.2 Utility Grid

Follow the regulations related to the utility grid.

NOTICE

All electrical connections must be in accordance with local and national standards. Only with the permission of the local utility grid company, the inverter can be connected to the utility grid.

1.3 Inverter

⚠ DANGER

Danger to life from electric shocks due to live voltage

Do not open the enclosure at any time. Unauthorized opening will void warranty and warranty claims and in most cases terminate the operating license.

⚠ WARNING

Risk of inverter damage or personal injury

- **Do not connect or disconnect the PV, battery and AC connectors when the inverter is running.**
- **Wait at least 10 minutes for the internal capacitors to discharge after all electric devices are removed and the inverter is powered off.**
- **Ensure that there is no voltage or current before connecting or disconnecting the PV , battery and AC connectors.**

⚠ WARNING

All safety instructions, warning labels, and nameplate on the inverter:

- **Must be clearly legible.**
- **Should not be removed or covered.**

⚠ CAUTION

Risk of burns due to hot components!

Do not touch any hot parts (such as the heat sink) during operation. Only the DC switch and the LED panel can safely be touched at any time.

NOTICE

Only qualified personnel can perform the country setting. Unauthorized alteration may cause a breach of the type-certificate marking.

Risk of inverter damage due to electrostatic discharge (ESD)!

By touching the electronic components, you may damage the inverter. For inverter handling, be sure to:

- **avoid any unnecessary touching;**
- **wear a grounding wristband before touching any connectors.**

1.4 Batteries

DANGER

Batteries deliver electric power, resulting in burns or a fire hazard when they are short circuited, or wrongly installed.

Lethal voltages are present at the battery terminals and cables connecting to the inverter. Severe injuries or death may occur if the cables and terminals in the inverter are touched.

NOTICE

Improper settings or maintenance can permanently damage the battery.

Incorrect inverter parameters will lead to the premature aging of battery.

2 Product Description

2.1 System Introduction

The inverter is a transformerless 1-phase hybrid inverter. As an integral component in the power system, the inverter is designed to convert the direct current power generated from the PV modules or batteries into grid-compatible AC current and feeds the AC current to the utility grid.

The 1-phase hybrid inverters are applicable to both on-grid and off-grid PV systems. With the integrated Energy Management System (EMS), they can control and optimize the energy flow so as to increase the self-consumption of the system.

WARNING

- **The inverter must only be operated with PV strings with class II protection in accordance with IEC 61730, application class A. It is not allowed for the positive pole or the negative pole of the PV strings to be grounded. This can cause the inverter to be destroyed.**
- **Damages to the product due to a faulty or damaged PV installation are not covered by warranty.**
- **Any use other than the one described in this document is not permitted.**
- **During the installation and operation of the inverter, please ensure that the positive or negative polarities of PV strings do not short-circuit to the ground. Otherwise, an AC or DC short-circuit may occur, resulting in equipment damage. The damage caused by this is not covered by the warranty.**
- **Do not short-circuit the Backup port during operation. Otherwise, the inverter or power distribution system will be seriously damaged. The loss is not covered by the SUNGROW warranty.**

NOTICE

- **For the TT utility grid, the N line voltage to ground must be 30 V or less.**
- **The utility grid must be a TN system for the off-grid application.**
- **The system is not suitable for supplying life-sustaining medical devices. It cannot guarantee backup power in all circumstances.**

2.2 Product Introduction

Model Description

The model description is as follows (take SH5.0RS as an example):

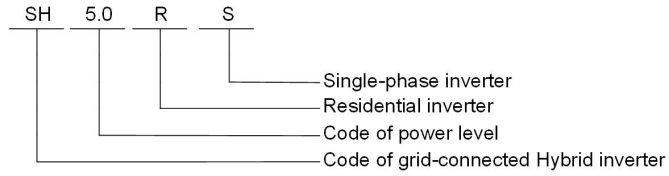

S007-G003

Appearance

The following figure shows the dimensions of the inverter. The image shown here is for reference only. The actual product received may differ.

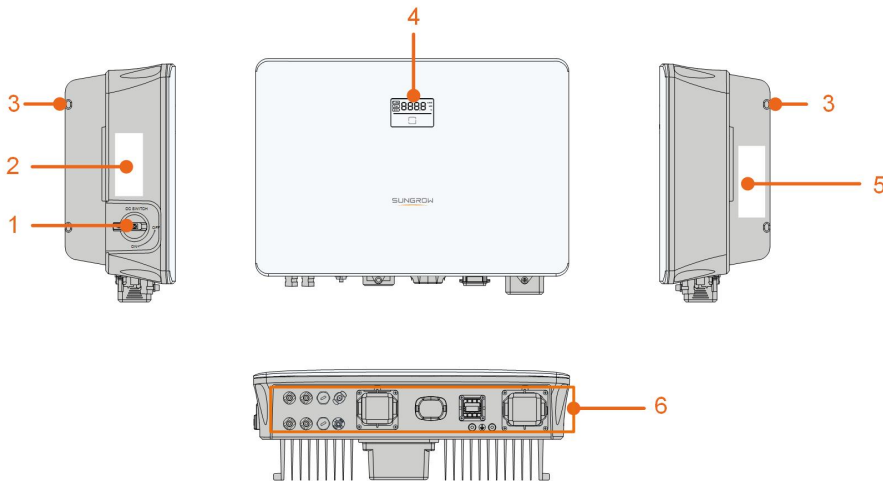

S007-G004

figure 2-1 Inverter Appearance

No.	Name	Description
1	DC switch	To safely disconnect the DC circuit whenever necessary.
2	Label	Information about COM2 pin definition, supported DRM modes, etc.
3	Hanger	To hang the inverter on the wall-mounting bracket.
4	LED panel	The LED screen indicates the running information and the LED indicator indicates the current working state of the inverter.
5	Nameplate	To clearly identify the product, including device model, S/N, important specifications, marks of certification institutions, etc.
6	Electrical connection area	PV terminals, battery terminal, AC terminal, additional grounding terminal and communication terminals.

Dimensions

The following figure shows the dimensions of the inverter.

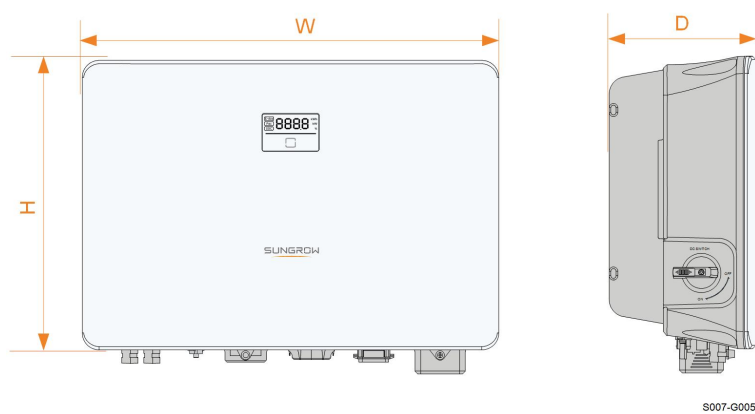







figure 2-2 Dimensions of the Inverter

Inverter Model	W (mm)	H (mm)	D (mm)
SH3.0RS / SH3.6RS / SH4.0RS / SH5.0RS / SH6.0RS	490	340	170

2.3 Symbols on the Product

Symbol	Explanation
	Parameters on the PV side.
	Parameters on the battery side.
	Parameters on the AC on-grid side.
	Parameters on the AC backup side.
	Regulatory compliance mark.
	TÜV mark of conformity.
	CE mark of conformity.
	UKCA mark of conformity.
	The inverter does not have a transformer.
	Do not dispose of the inverter together with household waste.

Symbol	Explanation
	Disconnect the inverter from all the external power sources before maintenance!
	Read the user manual before maintenance!
	Burn danger due to the hot surface that may exceed 60°C.
 	Danger to life due to high voltages! Do not touch live parts for 10 minutes after disconnection from the power sources. Only qualified personnel can open and maintain the inverter.
	Additional grounding point.

* The table shown here is for reference only. The actual product received may differ.

2.4 LED Panel

The LED panel with a display screen and an indicator is on the front of the inverter.

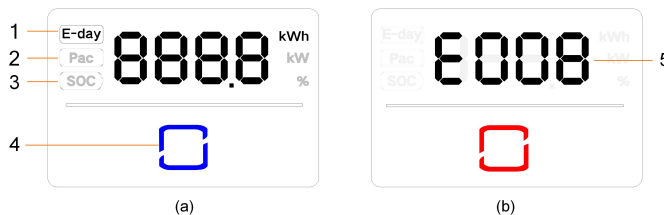

figure 2-3 LED Panel

(a) Normal state



(b) Error state

No.	Name	Description
1	E-day	Today's energy yield
2	Pac	Real-time AC output power
3	SOC	Battery SOC (State of Charge)
4	LED indicator	To indicate the working state of the inverter. Touch it to switch the information in normal state or view multiple error codes in error state.
5	Error code	The error code in the figure is just an example.

- In normal state, the E-day, Pac and SOC information will be displayed alternately. Also you can touch the LED indicator to switch the information.
- In error state, touch the LED indicator to view multiple error codes.

- If there is no operation for 5 minutes, the display screen will be off. Touch the LED indicator to activate it.

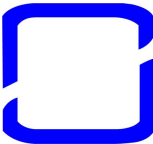
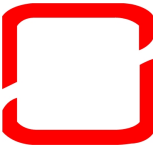
table 2-1 State description of the LED indicator

LED color	State	Definition
 Blue	On	The inverter is operating normally.
	Flashing	The inverter is at standby or startup state (not feeding power into the grid).
 Red	On	A system fault has occurred.
 Gray	Off	Both the AC and DC sides are powered down.

2.5 DC Switch

The DC switch is used to safely disconnect the DC circuit whenever necessary.

The inverter operates automatically when input and output requirements are met. Rotate the DC switch to the “OFF” position to stop the inverter when a fault occurs or when you need to stop the inverter.



Turn the DC switch to the “ON” position before restarting the inverter.

2.6 PV Energy Storage System (PV ESS)

2.6.1 PV Energy Storage System (PV ESS)

The following figure shows inverter application in a PV energy storage system.

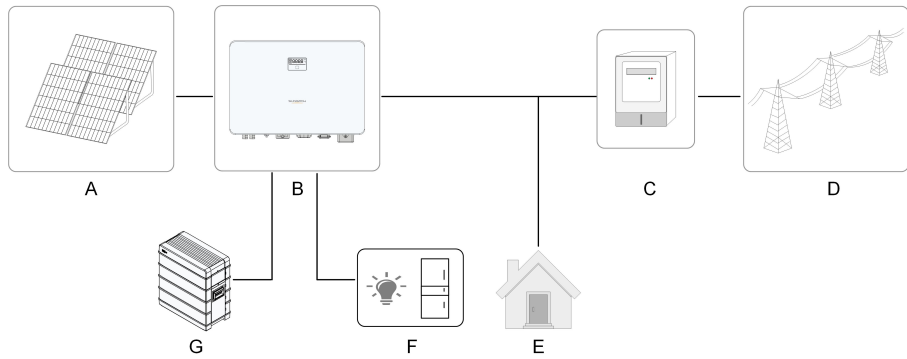

S007-G001

figure 2-4 PV Energy Storage System

Item	Description	Note
A	PV strings	Compatible with monocrystalline silicon, polycrystalline silicon, and thin-film modules without grounding.
B	Inverter	SH3.0RS, SH3.6RS, SH4.0RS, SH5.0RS, SH6.0RS.
C	Metering device	Meter cupboard with power distribution system.
D	Utility grid	TT , TN-C , TN-S, TN-C-S.
E	Loads	Common loads, which will be lack of power when grid is blackout.
F	Protected house loads	Loads, connected to inverter backup port, which need uninterrupted power supply.
G	Battery (optional)	A Li-ion battery.

The following figure shows the common grid configurations.

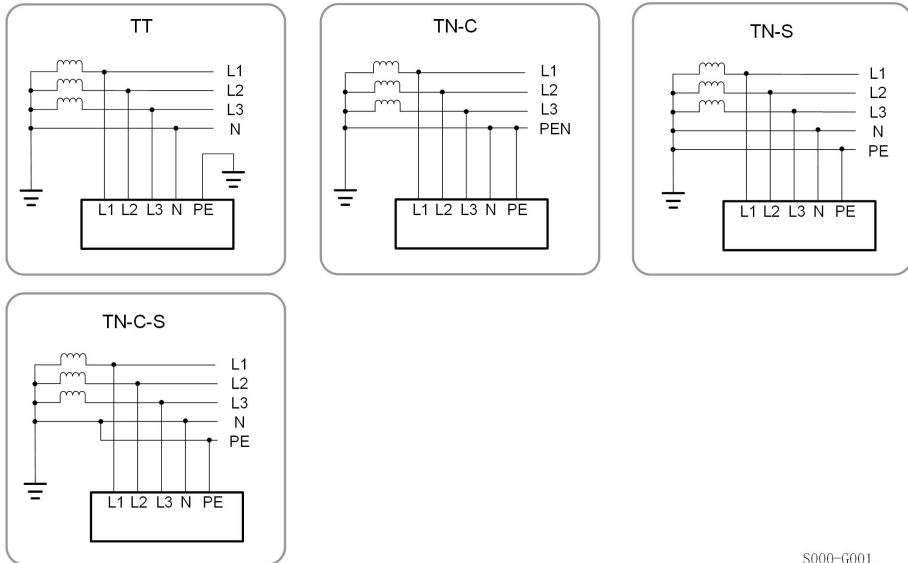

S000-G001

2.6.2 Declaration For Back-Up Function

The following statement involves SUNGROW general policies about the hybrid inverters described in this document.

- 1 For hybrid inverters, the electrical installation typically includes connection of the inverter to both PV modules and batteries. If there is no available power from batteries or PV modules in backup mode, the backup power supply will be automatically terminated. SUNGROW shall hold no liability for any consequences arising from failing to observe this instruction.
- 2 Normally, the Back-Up switching time is less than 10 ms. However, some external factors may cause the system to fail on Back-Up mode. Therefore, the users must be aware of conditions and follow the instructions as below:
 - Do not connect loads that are dependent on a stable energy supply for a reliable operation.
 - Do not connect the loads whose total capacity is greater than the maximum Back-Up capacity.
 - Do not connect the loads that may cause very high start-up current surges, such as air-conditioner, high-power pump, vacuum cleaner, and hair drier.
 - Due to the condition of the battery itself, battery current might be limited by some factors, including but not limited to the temperature and weather.

Declaration For Back-Up Overload Protection

The inverter will restart in case of overload protection. The time required for restarting will increase (10 min at most) if overload protection repeats. Try to reduce Back-Up load power within maximum limitation or remove the loads which may cause very high start-up current surges.

2.7 Retrofitting the Existing PV System

The hybrid inverter is compatible with any single-phase PV grid-connected inverters. An existing PV system can be retrofitted to be a PV ESS with the addition of the hybrid inverter.

The power generation from the existing PV inverter will be firstly provided to the loads and then charge the battery. With the energy management function of the hybrid inverter, the self-consumption of the new system will be greatly improved.

Retrofit the Existing PV Inverter(s) to the Hybrid Inverter On-grid Port

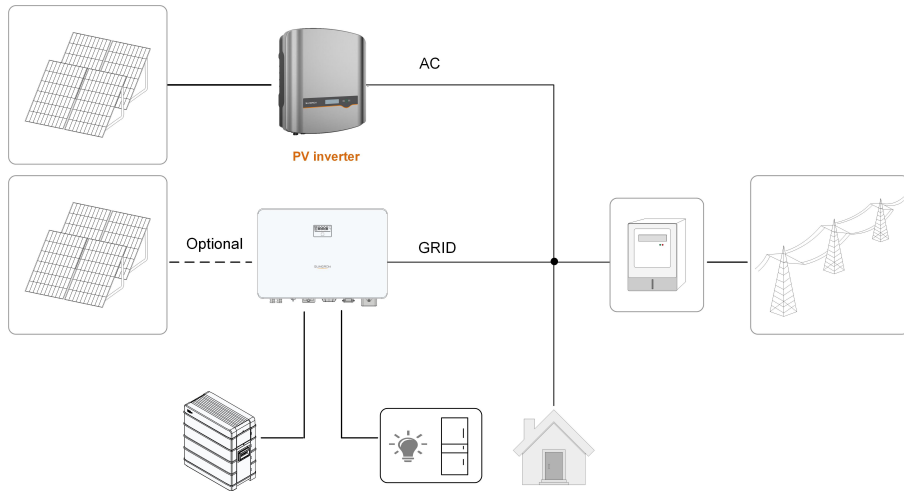

S007-G007

figure 2-5 Retrofit the Existing PV Inverter(s) to the Hybrid Inverter On-grid Port

The AC terminal of the PV inverter and the GRID terminal of the hybrid inverter are combined to the grid.

Retrofit the Existing PV Inverter(s) to the Hybrid Inverter Off-grid Port

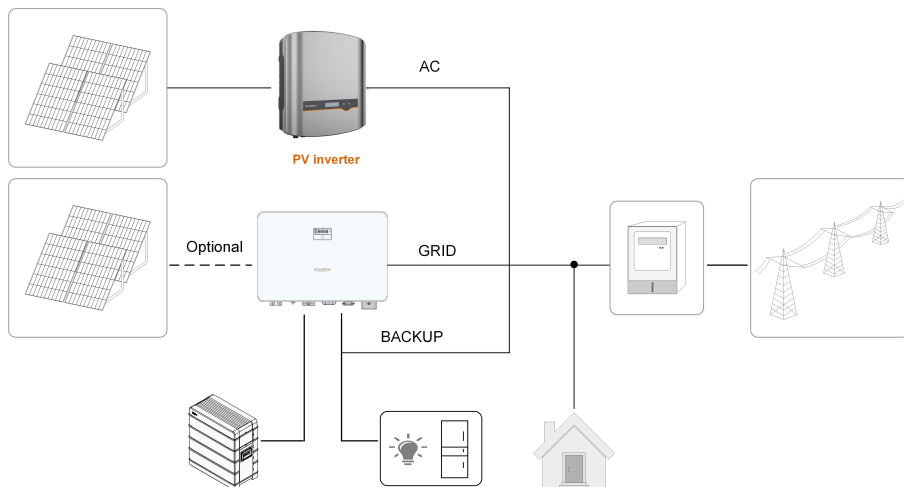

S007-G009

figure 2-6 Retrofit the Existing PV Inverter(s) to the Hybrid Inverter Off-grid Port

The off-grid port retrofits the existing PV system in order to maximize the use of PV energy by allowing the PV inverter to work even when off-grid.

The AC terminal of the PV inverter and the BACK-UP terminal of the hybrid inverter are combined to the backup loads.

The PV inverter power cannot exceed the nominal power of the hybrid inverter .



- In zero-export scenario, the hybrid inverter can only ensure no power exported to grid itself but does not ensure zero-export for the PV inverter. Please contact the PV inverter manufacturer for its zero-export solution.
- PV modules for hybrid inverter are optional.

3 Function Description

3.1 Safety Function

3.1.1 Protection

Several protective functions are integrated in the inverter, including short circuit protection, grounding insulation resistance surveillance, residual current protection, anti-islanding protection, DC overvoltage / over-current protection, etc.

3.1.2 Ground Fault Alarm

Due to the transformerless topology of the product, the occurrence of ground faults on DC side during operation can lead to irreparable damage. Damages to the product due to a faulty or damaged DC installation are not covered by warranty. The product is equipped with a protective device that checks whether a ground fault is present during the starting sequence. The product is not protected during operation.

Ensure that the DC installation is carried out correctly and no ground fault occurs during operation.

If a ground fault occurs, the buzzer inside the inverter will beep and the LED indicator will turn red.

3.2 Energy Conversion and Management

The inverter converts the DC power from the PV array or the battery to the AC power, in conformity with the grid requirements. It also transmits the DC power from the PV panel to the battery.

With the bidirectional converter integrated inside, the inverter can charge or discharge the battery.

Two string MPP trackers are used to maximize the power from PV strings with different orientations, tilts, or module structures.

3.2.1 Power Derating

Power derating is a way to protect the inverter from overload or potential faults. In addition, the derating function can also be activated following the requirements of the utility grid. Situations requiring inverter power derating are:

- over-temperature (including ambient temperature and module temperature)
- high input voltage
- grid under-voltage

- grid over-voltage
- grid over-frequency
- power factor (when values out of the rated values)

3.2.2 DRM (“AU”/“NZ”)

The inverter provides a terminal block for connecting to a demand response enabling device (DRED). The DRED asserts demand response modes (DRMs). The inverter detects and initiates a response to all supported demand response commands within 2s.

The following table lists the DRMs supported by the inverter.

table 3-1 Demand Response Modes (DRMs)

Mode	Explanation
DRM0	The inverter is in the state of “Turn off”.
DRM1	The import power from the grid is 0.
DRM2	The import power from the grid is no more than 50 % of the rated power.
DRM3	The import power from the grid is no more than 75 % of the rated power.
DRM4	The import power from the grid is 100 % of the rated power, but subject to the constraints from other active DRMs.
DRM5	The feed-in power to the grid is 0.
DRM6	The feed-in power to the grid is no more than 50 % of the rated power.
DRM7	The feed-in power to the grid is no more than 75 % of the rated power.
DRM8	The feed-in power to the grid is 100 % of the rated power, but subject to the constraints from other active DRMs.

The DRED may assert more than one DRM at a time. The following shows the priority order in response to multiple DRMs.

Multiple Modes	Priority Order
DRM1...DRM4	DRM1 > DRM2 > DRM3 > DRM4
DRM5...DRM8	DRM5 > DRM6 > DRM7 > DRM8

3.2.3 Regular Operational Voltage Range

The inverters can operate within the allowable voltage range for at least the specified observation time. The setting of the conditions depends on whether the connection is due to a normal operational start-up or an automatic reconnection after tripping of the interface protection.

When the voltage level is out of the operational levels, the inverter will disconnect from the grid within the protection time. If a disturbance lasts less than the required protection time, the inverter can reconnect to the grid once the voltage level goes back to normal levels after the disturbance.

3.2.4 Regular Operational Frequency Range

The inverter can operate within its frequency range for at least the specified observation time. The setting of conditions depends on whether the connection is due to a normal operational start-up or an automatic reconnection after tripping of the interface protection.

When the frequency level is outside the operational levels, the inverter will disconnect from the grid. If a disturbance lasts less than the required protection time, the inverter can reconnect to the grid once the frequency level goes back to normal levels after the disturbance.

3.2.5 Reactive Power Regulation

The inverter is capable of operating in reactive power regulation modes for the purpose of providing support to the grid. The reactive power regulation mode can be set via the iSolar-Cloud App.

3.3 Battery Management

Li-ion battery from SUNGROW, LG Chem and BYD are compatible with the PV ESS , further battery models will be made compatible in the future.

The currently supported battery brands and models are shown in the following table.

Brand	Model	Firmware Version
SUN-GROW	SBR096/128/160/192	≥ SBRBCU-S_22011.01.05
LG Chem	RESU7H_Type_R	DC-DC converter version ≥ 4.8
	RESU10H_Type_R	Battery management system (BMS) version ≥ 1.7.0.1
BYD	Battery-Box Premium HVS 5.1, 7.7, 10.2	Battery management system (BMS) version ≥ 3.16
	Battery-Box Premium HVM 8.3, 11.0, 13.8, 16.6, 19.3, 22.1	Battery management unit (BMU) version ≥ 3.7



The table is continually updated. If the battery model is not in the table, consult SUNGROW if it is supported.

To maximize the battery life, the inverter will perform battery charge, discharge, and battery maintenance based on the battery status communicated by the BMS.

NOTICE

The recommended parameters listed in this section may be updated or revised due to product development. Please refer to the manual supplied by the battery manufacturer for the latest information.

State Definition

In order to avoid overcharging or deep discharging of the battery, three battery statuses according to different voltage ranges has been defined, as shown in the following table.

table 3-2 Battery Status Definition

Type	Port Voltage / SOC		
	Empty	Normal	Full
SUNGROW (SBR096/128/160/ 192)	SOC < 5 %	5 %...100 % (by default)	SOC = 100 %
LG Chem(RE- SU7H_Type_R) LG Chem(RE- SU10H_Type_R)	SOC < 8 %	8 %...100 % (by default)	SOC = 100 %
BYD (Battery-Box Premium HVM / HVS)	SOC < 5 %	5 %...100 %) (by default)	SOC = 100 %

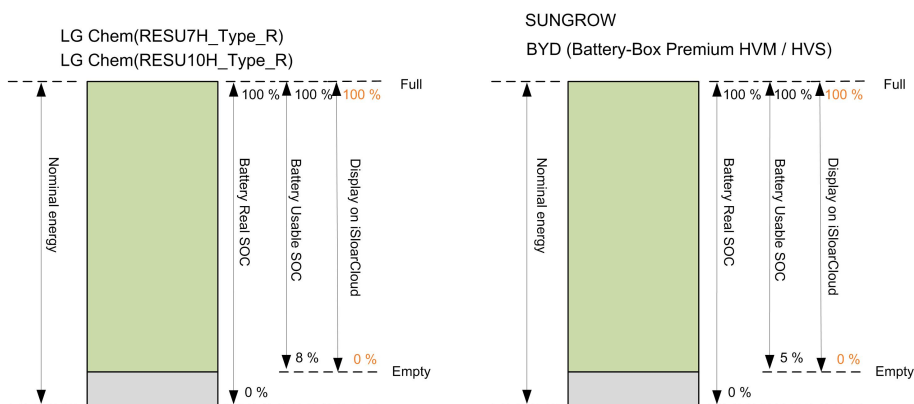

In the off-grid state, the LG Chem battery can only supply power to loads of maximum 5KW (such as RESU10H_Type_R). For the first operation of the inverter with LG Chem battery, either PV or grid needs to power the inverter to activate the LG Chem battery.

The SOC limits of Li-ion batteries can be modified via the iSolarCloud App by qualified personnel.

3.3.1 Charge Management

Backup Charge Management

The emergency charge management function is to protect the battery from the damage caused by long time excessive discharge. The inverter cannot respond to discharge command during emergency charge. The following tables describe the emergency charge conditions for different types of batteries.

table 3-3 Backup Charge Management for Li-ion Battery

Status	Conditions
Trigger	Either of the following conditions is met:
	<ul style="list-style-type: none"> • $SOC \leq (\text{Min. SOC}) - 3\%$ (valid only when the Min. SOC is $\geq 3\%$). • A battery under-voltage warning is triggered. • An emergency charge command is reported to the inverter.
	All the following conditions are met:
Finish	<ul style="list-style-type: none"> • $SOC \geq (\text{Min. SOC}) - 1\%$ (valid only when the Min. SOC is $\geq 3\%$). • The battery under-voltage warning is cleared. • The emergency charge command reported to the inverter is cleared.

table 3-4 Default SOC Conditions for Li-ion Battery Backup Charge

Type	Trigger SOC	Finishing SOC
SUNGROW	$SOC \leq 2\%$	$SOC \geq 4\%$
LG Chem	$SOC \leq 5\%$	$SOC \geq 7\%$
BYD (Battery-Box Premium HVM / HVS)	$SOC \leq 2\%$	$SOC \geq 4\%$

Normal Charge Management

When the battery voltage is within the normal range, the inverter can charge the battery if the PV power is higher than the load power and can ensure that the battery is never over-charged.

The maximum allowable charge current is limited to the smaller value among the following:

- the maximum charge current of the inverter (30A);
- the maximum / recommended charge current from the battery manufacturer.

For this reason, the battery charge power may not reach the nominal power.



- If the PV voltage is higher than the upper limit value of MPP voltage (560 V), the battery cannot charge.
- The hybrid inverter will start to charge the battery when the export power value exceeds a pre-defined threshold value of 70 W.

3.3.2 Discharge Management

Discharge management can effectively protect the battery from deep discharging.

The maximum allowable discharge current is limited to the smaller value among the following:

- the maximum discharge current of the inverter (30A);
- the maximum / recommended discharge current from the battery manufacturer.

For this reason, the battery discharge power may not reach the nominal power.



- If the PV voltage is higher than the upper limit value of MPP voltage (560 V), the battery cannot discharge.
- The hybrid system will start to discharge the battery when the import power value exceeds a threshold value of 70 W.

3.4 PID Recovery Function

The inverter is equipped with PID phenomenon recovery function to improve the PV power generation. During the power generation process, the inverter could carry out a main Anti-PID function without any influence to the grid side thanks to a particular technology. There is no need to make any settings to enable the PID recovery function.

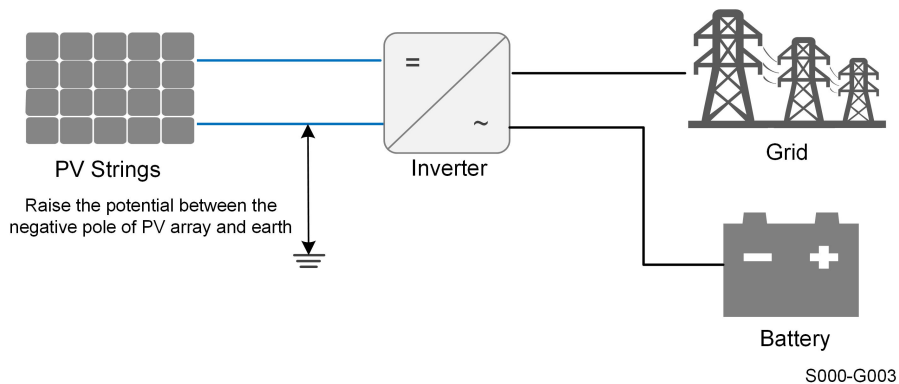

figure 3-1 PID Recovery Scheme

⚠ DANGER

Keep the DC switch "ON" in the PID recovery process. During the process, there is voltage hazard between inverter / PV module live conductors and ground. Do not touch any of them.

3.5 Communication and Configuration

The inverter provides various ports for device and system monitoring, including RS485, Ethernet, WLAN, and CAN; various parameters can be configured for optimal operation. All the inverter information is accessible through the iSolarCloud App.

3.6 Import Power Limit Function

Import power is the sum of the battery charging power and the load power of the Backup. Following local regulations, calculate the maximum system tolerable power based on the

wire and circuit breaker that required by the selected model, and the value can be set as the **Import Power Limit**. **Import Power Limit** can be set on the iSolarCloud App.

4 Unpacking and Storage

4.1 Unpacking and Inspection

The device is thoroughly tested and strictly inspected before delivery. Nonetheless, damage may still occur during shipping. For this reason, please conduct a thorough inspection after receiving the device.

- Check the packing case for any visible damage.
- Check the scope of delivery for completeness according to the packing list.
- Check the inner contents for damage after unpacking.

Contact SUNGROW or the transport company in case of any damage or incompleteness, and provide photos to facilitate services.

Do not dispose of the original packing case. It is recommended to store the device in the original packing case when the device is decommissioned.

4.2 Inverter Storage

Proper storage is required if the inverter is not installed immediately.

- Store the inverter in the original packing case with the desiccant inside.
- The storage temperature must be always between -30°C and $+70^{\circ}\text{C}$, and the storage relative humidity must be always between 0 and 95 %, non-condensing.
- In case of stacking storage, the number of stacking layers should never exceed the limit marked on the outer side of the packing case.
- The packing case should be upright.
- If the inverter has been stored more than half a year, the qualified personnel should thoroughly check and test it before installation.

5 Mechanical Mounting

⚠ WARNING

Respect all local standards and requirements during mechanical installation.

5.1 Safety during Mounting

⚠ DANGER

Make sure there is no electrical connection before installation.

In order to avoid electric shock or other injury, make sure that holes will not be drilled over any electricity or plumbing installations.

⚠ CAUTION

Risk of injury due to improper handling

- Always follow the instructions when moving and positioning the inverter.
- Improper operation may cause injuries or serious wounds.

In the case of poor ventilation, the system performance may compromise.

- Keep the heat sinks uncovered to ensure heat dissipation performance.

5.2 Location Requirements

Select an optimal mounting location for safe operation, long service life and expected performance.

- The inverter with protection rating IP65 can be installed both indoors and outdoors.
- Install the inverter at a place convenient for electrical connection, operation, and maintenance.

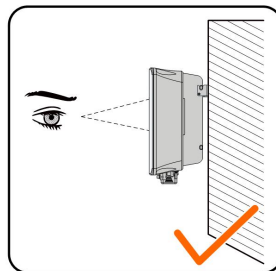
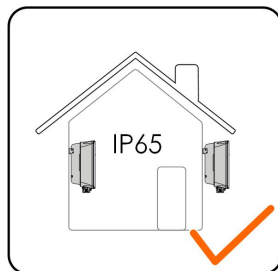

S006-I001

5.2.1 Environment Requirements

- The installation environment must be free of inflammable or explosive materials.
- The location should be not accessible to children.
- The ambient temperature and relative humidity must meet the following requirements.

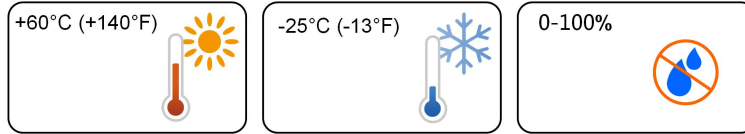

- Avoid direct exposure to sun, rain and snow.
- The inverter should be well ventilated. Ensure air circulation.

5.2.2 Carrier Requirements

The concrete wall should be capable of withstanding a force of four times the weight of the inverter and be suitable for the dimensions of the inverter.

The installation carrier should meet the following requirements:



S006-I003

5.2.3 Angle Requirements

Install the inverter vertically. Never install the inverter horizontally, or at forward/backward tilted, side tilted, or upside down.

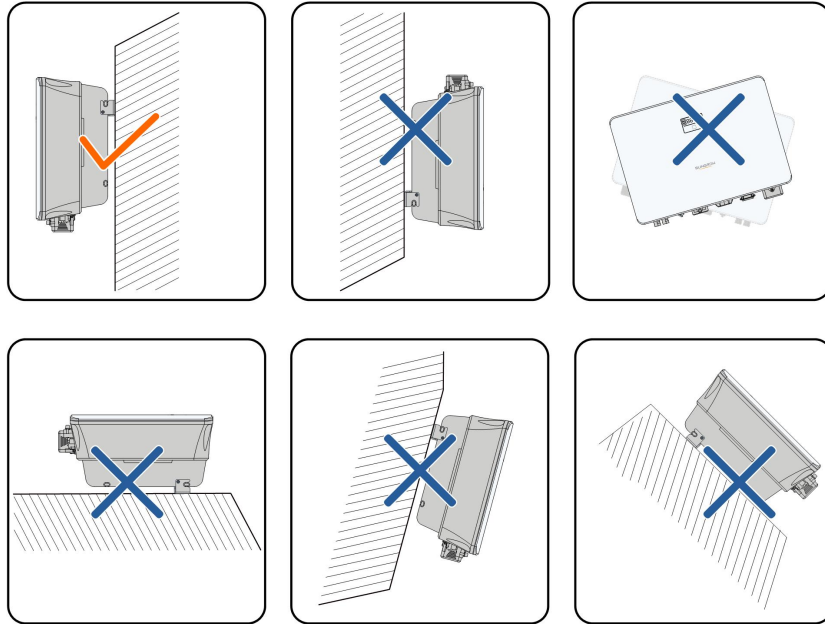

S007-I004

5.2.4 Clearance Requirements

Reserve enough clearance around the inverter to ensure sufficient space for heat dissipation.

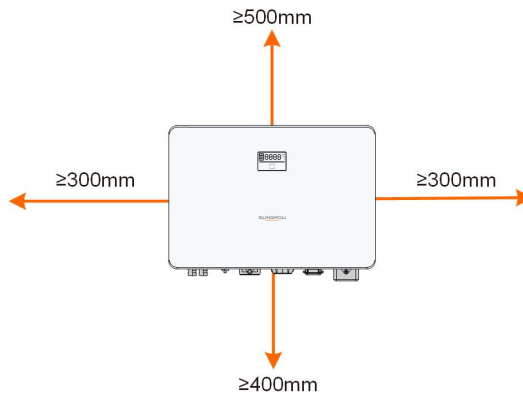

S007-I005

In case of multiple inverters, reserve specific clearance between the inverters.

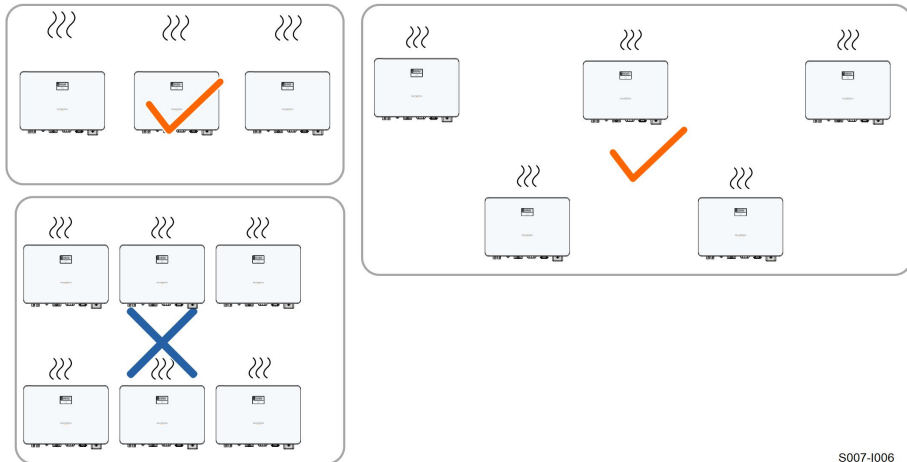



S007-I006

Install the inverter at an appropriate height for ease of viewing the screen and LED indicator and operating switch(es).

5.3 Installation Tools

Installation tools include but are not limited to the following recommended ones. If necessary, use other auxiliary tools on site.

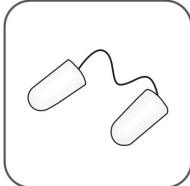
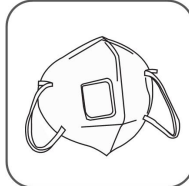
table 5-1 Tool specification

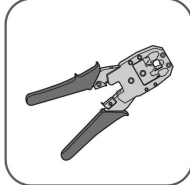
			
Goggles	Earplugs	Dust mask	Protective gloves
			
Insulated shoes	Utility knife	Marker	Wrist strap
			
Wire cutter	Wire stripper	Hydraulic plier	RJ45 crimping tool



MC4 terminal
crimping tool (4
mm²–6 mm²)



Tube terminal
crimping tool (0.5
mm²–1.0 mm²)

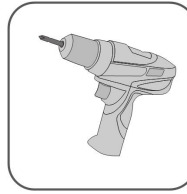

Electric screwdriver
(M4, M5, M6)

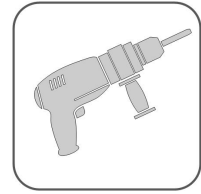

Hammer drill (φ10)



Phillips screwdriver
(M4)



Vacuum cleaner

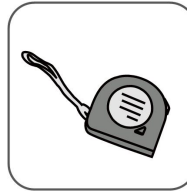

Measuring tape

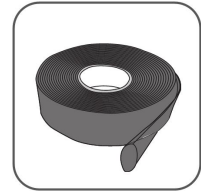

Heat shrink tubing



Heat gun

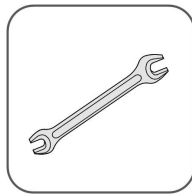

Wrench (33 mm, 35
mm)

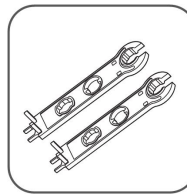

MC4 terminal
wrench

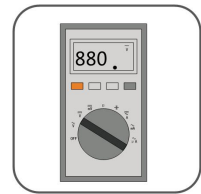

Multimeter (≥ 600
Vdc)

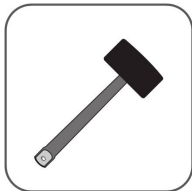

Rubber mallet

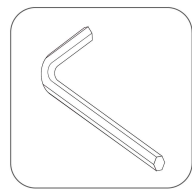

Allen wrench (T27)

5.4 Moving the Inverter

Before installation, remove the inverter from the packing case and move it to the installation site. Follow the instructions below as you move the inverter:

- Always be aware of the weight of the inverter.
- Lift the inverter using the handles positioned on both sides of the inverter.
- Move the inverter by one or two people or by using a proper transport tool.
- Do not release the equipment unless it has been firmly secured.

5.5 Installing the Inverter

Inverter is installed on the wall by means of wall-mounting bracket and the expansion plug sets.

The expansion plug set shown below is recommended for the installation.

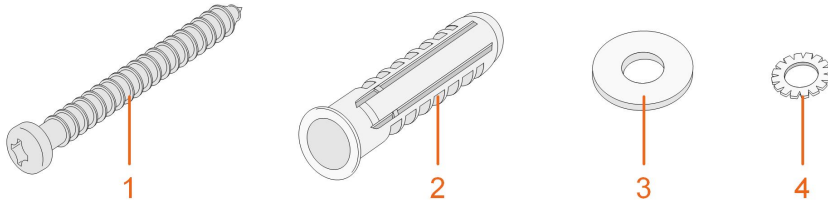

(1) Self-tapping screw M6 (2) Expansion tube (3) Fender washer (4) Spring washer

step 1 Place the wall-mounting bracket to a proper position on the wall. Mark the positions and drill the holes.

NOTICE

Observe the level on the bracket and adjust until the bubble is in the middle position.

The depth of the holes should be about 70 mm.

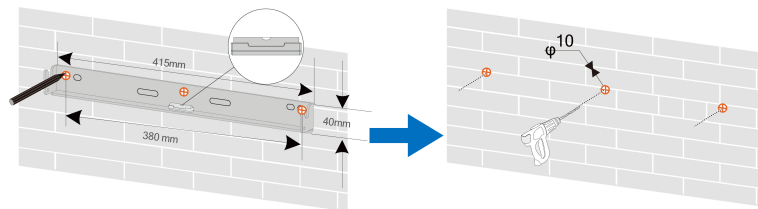

S006-I008

* The image shown here is for reference only. The actual product received may differ.

step 2 Place the expansion tubes into the holes. Then secure the wall-mounting bracket to the wall firmly with the expansion bolt sets.

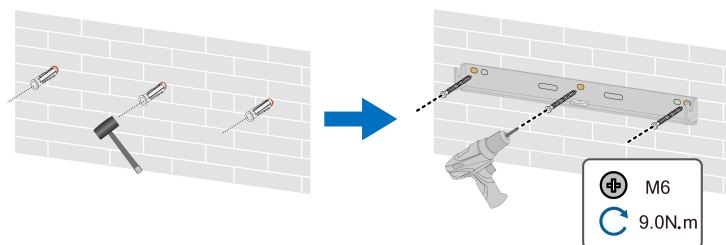

S006-I009

step 3 Lift the inverter and slide it down along the wall-mounting bracket to make sure they match perfectly. Use two screw sets to lock both left and right sides.

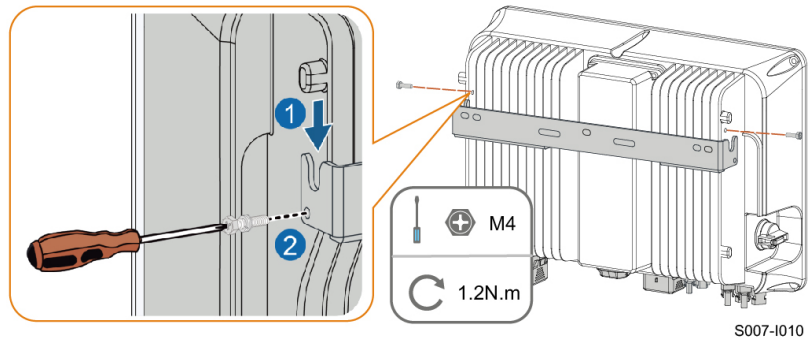

-- End

6 Electrical Connection

6.1 Safety Instructions

Prior to any electrical connections, keep in mind that the inverter has dual power supplies. It is mandatory for the qualified personnel to wear personal protective equipments (PPE) during the electrical work.

DANGER

Danger to life due to a high voltage inside the inverter!

- **The PV string will generate lethal high voltage when exposed to sunlight.**
- **Before starting electrical connections, disconnect the DC switch and AC circuit breakers and prevent them from inadvertent reconnection.**
- **Ensure that all cables are voltage free before performing cable connection.**

WARNING

- **Any improper operations during cable connection can cause device damage or personal injury.**
- **Only qualified personnel can perform cable connection.**
- **All cables must be undamaged, firmly attached, properly insulated and adequately dimensioned.**

NOTICE

Comply with the safety instructions related to the PV strings and the regulations related to the utility grid.

- **All electrical connections must be in accordance with local and national standards.**
- **Only with the permission of the local utility grid company, the inverter can be connected to the utility grid.**

6.2 Terminal Description

All electrical terminals are located at the bottom of the inverter.

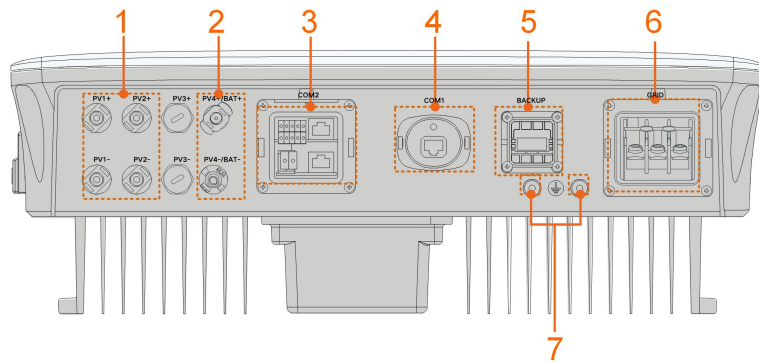

S007-E001

figure 6-1 Terminals

* The image shown here is for reference only. The actual product received may differ.

table 6-1 Terminal Description

No.	Name	Description	Decisive Voltage Classification
1	PV1+, PV1-, PV2+, PV2-	MC4 terminals for PV input. The terminal number depends on inverter model.	DVC-C
2	PV4+/BAT+, PV4-/BAT-	Connectors for the battery power cables	DVC-C
3	COM2	Communication connection for RSD, BMS, RS485, DRM/DI, DO and smart energy meter.	DVC-A
4	COM1	Communication accessory port to be connected to WiNet-S communication module.	DVC-A
5	BACKUP	AC terminal for Backup loads	DVC-C
6	GRID	AC terminal to connect to the grid.	DVC-C
7		Additional grounding terminal.	Not applicable



PV3± and PV4± are not applicable to Hybrid inverter.
Do not connect PV strings to PV4±/BAT± ports.

The pin definition of COM2 terminal is shown in the following label.

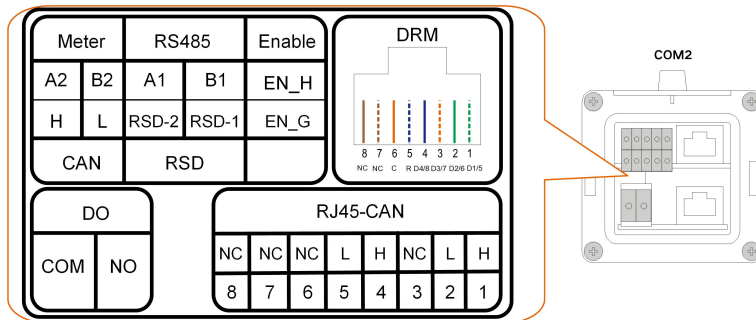

figure 6-2 Label of COM2 Terminal

table 6-2 Label Description of COM2 Terminal

Label	Description
Meter	A2, B2 For Smart Energy Meter
CAN	H, L For Li-ion battery communication via CAN protocol. For inverter daisy chain (Reserved)
RS485	A1, B1 For LG Chem Li-ion battery communication via RS485 protocol.
RSD	RSD-1, RSD-2 Reserved (Detail availability contact SUNGROW)
Enable	EN_H, EN_G For battery 12V signal, e.g. LG Chem battery.
DRM	D1/5, D2/6, D3/7, D4/8, R, C For external Demand Response Enabling Device ("AU"/"NZ") For Ripple Control Receiver
DO	COM, NO Reserved (Detail availability contact SUNGROW)
RJ45-CAN	H, L For Li-ion battery communication via CAN protocol.

6.3 Electrical Connection Overview

The electrical connection should be realized as follows:

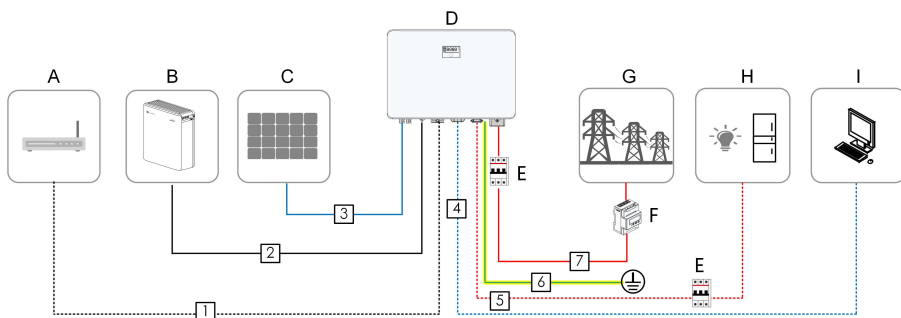

S007-E005

(A) Router	(B) Battery	(C) PV string
(D) Inverter	(E) AC circuit breaker	(F) Smart energy meter
(G) Grid	(H) Backup loads	(I) Monitoring device

table 6-3 Cable Requirements

No.	Cable	Type	Cable Diameter	Cross-section
1	Ethernet cable	CAT 5E outdoor shielded network cable	4.8 – 6 mm	0.08 – 0.2 mm ²
2	Battery power cable	Complying with 600 V and 35A standard	5.5 – 8 mm	4 – 6 mm ²
3	PV cable	Outdoor multi-core copper wire cable complying with 600 V and 16 A standard	6 – 9 mm	4 – 6 mm ²
4	Communication cable	Shielded twisted pair	4.8 – 6 mm	0.5 – 1.0 mm ²
		CAT 5E outdoor shielded network cable	4.8 – 6 mm	0.08 – 0.2 mm ²
5	Backup cable	Outdoor 3-core copper wire cable	10 – 21 mm	4 – 6 mm ² (Recommend SH3.0RS: 4 mm ² , Others: 6 mm ²)
6	Additional Grounding cable	Outdoor single-core copper wire cable	The same as that of the PE wire in the AC cable	
7	AC cable	Outdoor 3-core copper wire cable	12 – 25.8 mm	6 – 16 mm ² (Recommend 10 mm ²)

If local standard have other requirements for cables, set the cable specification according to the local standard.

6.4 Backup Wiring Diagram

For AU/NZ/ZA

For Australia, New Zealand and South Africa, the neutral cable of GRID side and BACK-UP side must be connected together. Otherwise BACK-UP function will not work.

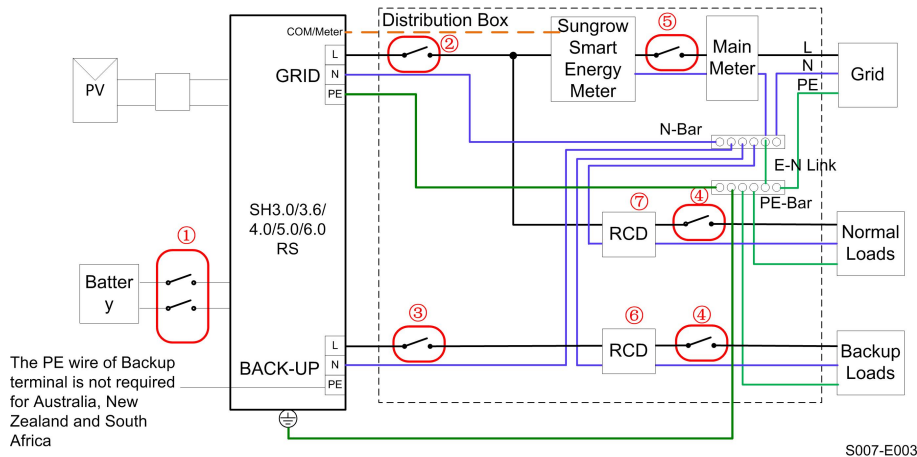

NO.	SH3.0/3.6/4.0/5.0/6.0RS
①	40A/600V DC breaker *
②	≤63A/230V/400V AC breaker
③	32A/230V/400V AC breaker
④	Depends on loads
⑤	Depends on household loads and inverter capacity
⑥⑦	30mA RCD (Comply with local regulation)

Note 1: * If the battery is integrated with a readily accessible internal DC breaker, no additional DC breaker is required.

Note 2: The recommended values in the table are for reference only. The actual values must comply with local standard and actual conditions.

Note 3: The rated current of breaker ② is suggested to lower than that of breaker ⑤.

Note 4: If the rated current of on-site power cables are lower than those recommended above, the breakers specification should be considered to match the power cables in first priority.

Note 5: The AC port takes power from the grid and is set according to the grid circuit breaker.

For other countries

For other countries, the following diagram is an example for grid systems without special requirement on wiring connection.

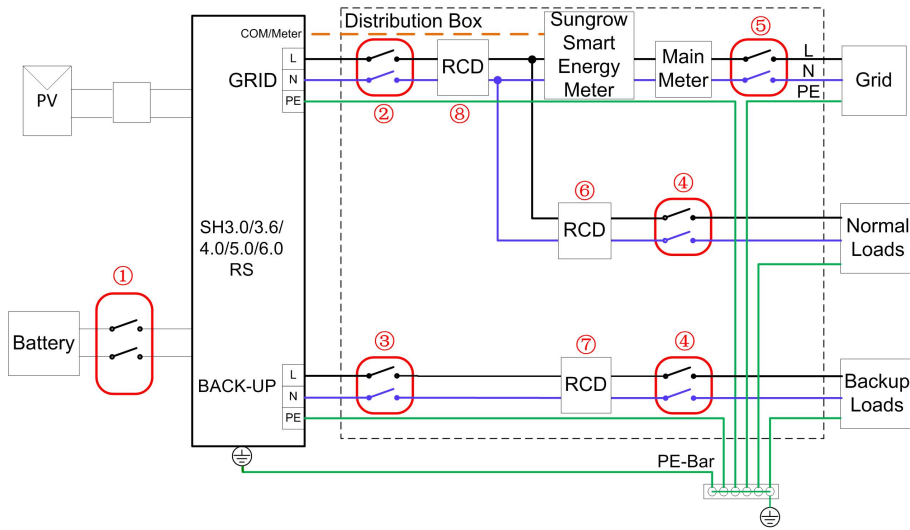

S007-E004

NO.	SH3.0/3.6/4.0/5.0/6.0RS
①	40A/600V DC breaker *
②	≤63A/230V/400V AC breaker
③	32A/230V/400V AC breaker
④	Depends on loads
⑤	Depends on household loads and inverter capacity (Optional)
⑥ ⑦	30mA RCD (Recommended)
⑧	300mA RCD (Recommended)

Note 1: * If the battery is integrated with a readily accessible internal DC breaker, no additional DC breaker is required.

Note 2: The recommended values in the table are for reference only. The actual values must comply with local standard and actual conditions.

Note 3: The rated current of breaker ② is suggested to lower than that of breaker ⑤.

Note 4: If the rated current of on-site power cables are lower than those recommended above, the breakers specification should be considered to match the power cables in first priority.

Note 5: The AC port takes power from the grid and is set according to the grid circuit breaker.

For TT system

In the TT system, the following diagram is an example for grid systems without special requirement on wiring connection.

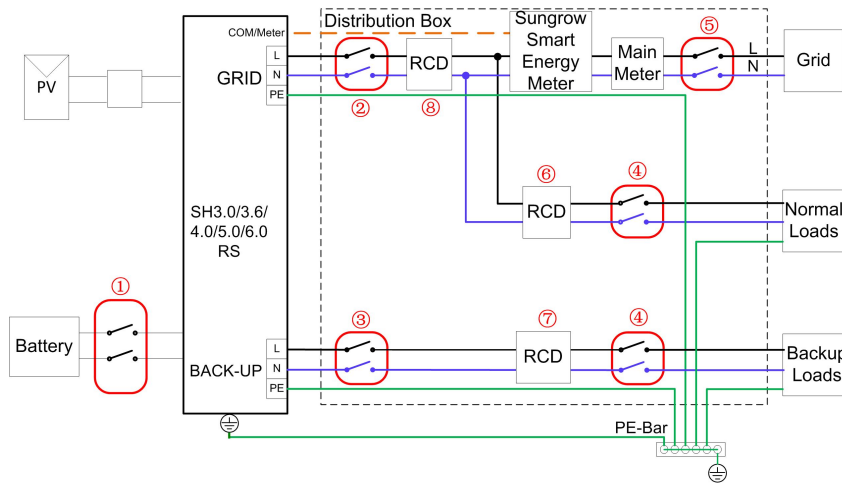

S007-E005

NO.	SH3.0/3.6/4.0/5.0/6.0RS
①	40A/600V DC breaker *
②	≤63A/230V/400V AC breaker
③	32A/230V/400V AC breaker
④	Depends on loads
⑤	Depends on household loads and inverter capacity (Optional)
⑥⑦	30mA RCD (Recommended)
⑧	300mA RCD (Recommended)

Note 1: * If the battery is integrated with a readily accessible internal DC breaker, no additional DC breaker is required.

Note 2: The recommended values in the table are for reference only. The actual values must comply with local standard and actual conditions.

Note 3: The rated current of breaker ② is suggested to lower than that of breaker ⑤.

Note 4: If the rated current of on-site power cables are lower than those recommended above, the breakers specification should be considered to match the power cables in first priority.

Note 5: The AC port takes power from the grid and is set according to the grid circuit breaker.

6.5 Additional Grounding Connection

⚠ WARNING

- Since the inverter is transformerless, neither the negative pole nor the positive pole of the PV string can be grounded. Otherwise, the inverter will not operate normally.
- Connect the additional grounding terminal to the protective grounding point before AC cable connection, PV cable connection, and communication cable connection.
- The ground connection of this additional grounding terminal cannot replace the connection of the PE terminal of the AC cable. Make sure those terminals are both grounded reliably. SUNGROW shall not be held liable for any damage caused by the violation.

6.5.1 Additional Grounding Requirements

All non-current carrying metal parts and device enclosures in the PV power system should be grounded, for example, mounts of PV modules and the inverter enclosure.

When there is only one inverter in the PV system, connect the additional grounding cable to a nearby grounding point.

When there are multiple inverters in the PV system, connect grounding points of all inverters and the PV array frames to the equipotential cable (according to the onsite conditions) to implement an equipotential connection.

6.5.2 Connection Procedure

Additional grounding cable and OT/DT terminal are prepared by customers.

step 1 Prepare the cable and OT/DT terminal.

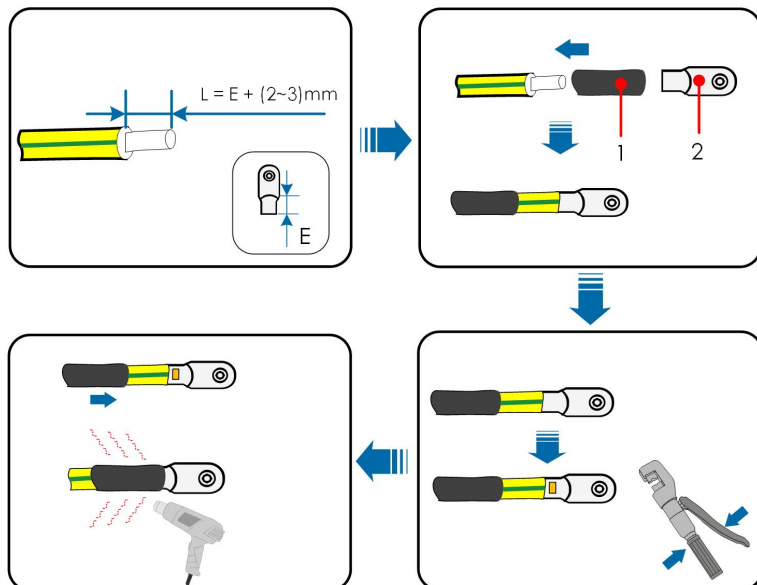

(1) Heat shrink tubing

(2) OT/DT terminal

step 2 Remove the screw on the grounding terminal and fasten the cable with a screwdriver.

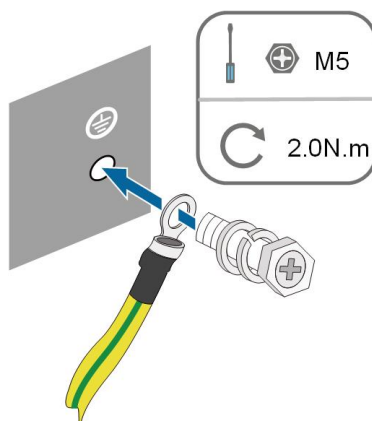

S000-E080

step 3 Apply paint to the grounding terminal to ensure corrosion resistance.

-- End

6.6 AC Cable Connection

6.6.1 AC Side Requirements



Connect the inverter to the grid only after getting an approval from the local electric power company.

Before connecting the inverter to the grid, ensure the grid voltage and frequency comply with requirements, for which, refer to "**Technical Data**". Otherwise, contact the electric power company for help.

AC Circuit Breaker

An independent two-pole circuit breaker must be installed on the output side of the inverter to ensure safe disconnection from the grid. The recommended specifications are as follows.

Inverter Model	Recommended Specification (back-up)	Recommended Specification (on-grid)
SH3.0/3.6/4.0/5.0/6.0RS	32 A	≤63 A

NOTICE

- **Determine whether an AC circuit breaker with greater overcurrent capacity is required based on actual conditions.**
- **Multiple inverters cannot share one circuit breaker.**
- **Never connect a load between the inverter and the circuit breaker.**

Residual Current Monitoring Device

With an integrated universal current-sensitive residual current monitoring unit included, the inverter will disconnect immediately from the mains power once a fault current with a value exceeding the limit is detected.

However if an external residual current device (RCD) is mandatory, the switch must be triggered at a residual current of 300 mA (recommended). RCD of other specifications can also be used according to local standard.

6.6.2 Connecting the AC Cable

step 1 Disconnect the AC circuit breaker and secure it against reconnection.

step 2 Unscrew the swivel nut and take out the sealing ring.

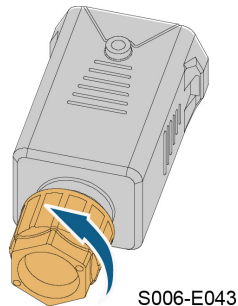

step 3 Thread the AC cable through the swivel nut, appropriate sealing and waterproof cover in sequence.

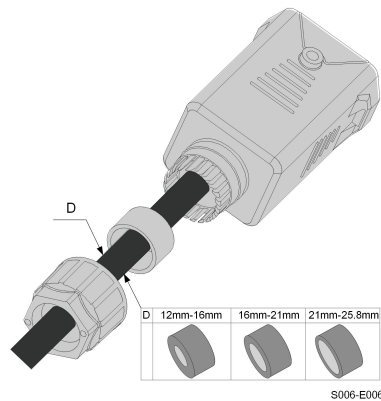

step 4 Strip the cable jacket and the wire insulation as shown in the following figure.

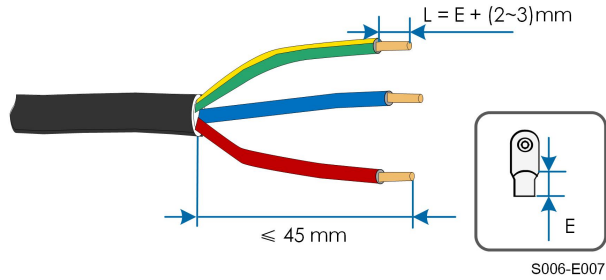

step 5 Crimp the OT/DT terminal.

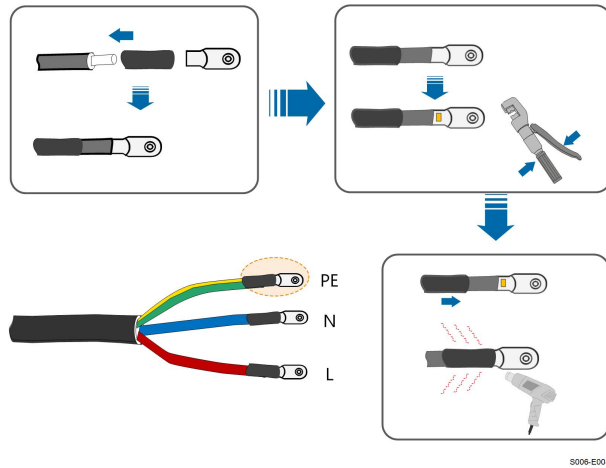

step 6 Remove the waterproof lid from the **GRID** terminal.

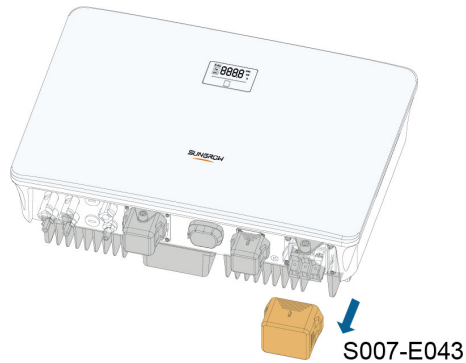

step 7 Fix all the wires to the terminals according to the assignment and tighten to a torque of 2.0 N•m with a screwdriver.

NOTICE

Observe the terminal assignment. Do not connect any phase line to the "PE" terminal or PE wire to "N" terminal. Otherwise, unrecoverable damage to the inverter may follow.

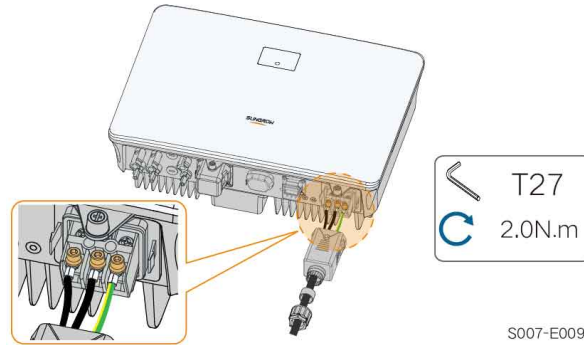

- step 8 Secure the AC waterproof cover to the inverter with a torque of 1.2 N•m and tighten the swivel nut to a torque of 5 N•m–6 N•m.

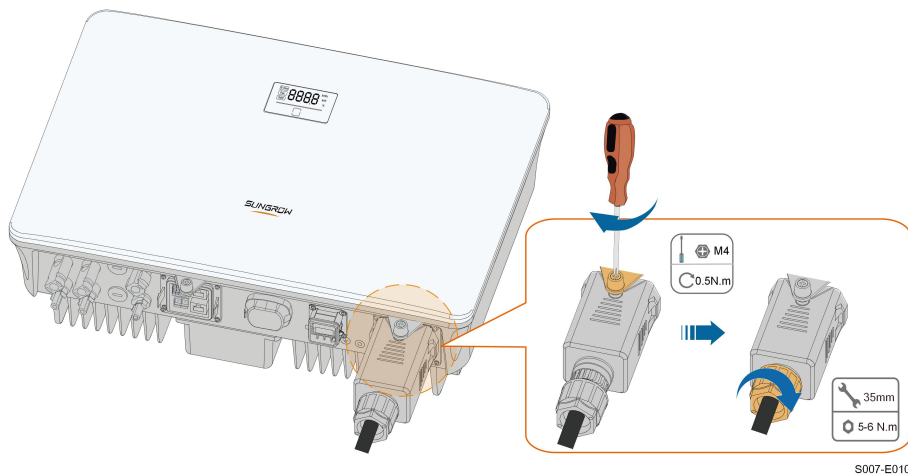

- step 9 Connect the PE wire to ground and the phase lines and the “N” line to AC circuit breaker. Then connect the AC circuit breaker to electric board.

- step 10 Make sure all wires are firmly installed via the right torque tool or dragging the cables slightly.

-- End

6.7 DC Cable Connection

⚠ DANGER

Danger of electric shock!

The PV array will generate lethal high voltage once exposed to sunlight.

WARNING

Make sure the PV array is well insulated to ground before connecting it to the inverter.

During the installation and operation of the inverter, please ensure that the positive or negative polarities of PV strings do not short-circuit to the ground. Otherwise, an AC or DC short-circuit may occur, resulting in equipment damage. The damage caused by this is not covered by the warranty.

NOTICE

Risk of inverter damage! Observe the following requirements. Failure to do so will void guarantee and warranty claims.

- **Make sure the maximum DC voltage and the maximum short circuit current of any string never exceed inverter permitted values specified in "Technical Data".**
- **Mixed use of different brand or model of PV modules in a PV string or a compromised PV string design composed with PV modules from rooftops of different orientation may not damage inverter but will cause system bad performance!**
- **The inverter enters standby state when the input voltage ranges between 560 V and 600 V. The inverter returns to running state once the voltage returns to the MPPT operating voltage range, namely, 40 V to 560 V.**

6.7.1 PV Input Configuration

- The inverters have two PV inputs, each with independent MPP tracker. Each DC input area can operate independently.
- The PV strings to two DC input areas may differ from each other, including PV module type, number of PV modules in each string, angle of tilt, and installation orientation.

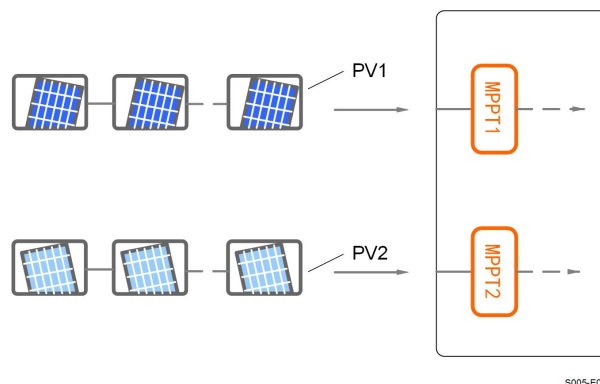

S005-E027

figure 6-3 PV Input Configuratinon

Prior to connecting the inverter to PV inputs, the following electrical specifications must be met simultaneously:

Inverter Model	Open-circuit Voltage Limit	Max. Current for Input Connector
SH3.0/3.6/4.0/ 5.0/6.0RS	600 V	20 A

6.7.2 Assembling the PV Connectors

⚠ DANGER

High voltage may be present in the inverter!

- **Ensure all cables are voltage-free before performing electrical operations.**
- **Do not connect the DC switch and AC circuit breaker before finishing electrical connection.**



SUNGROW provides corresponding PV connectors in the scope of delivery for quick connection of PV inputs. To ensure IP65 protection, use only the supplied connector or the connector with the same ingress of protection.

step 1 Strip the insulation from each DC cable by 7 mm–8 mm.

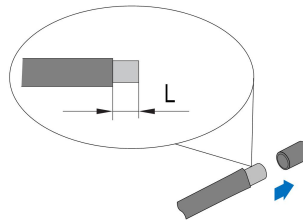

step 2 Assemble the cable ends with the crimping pliers.

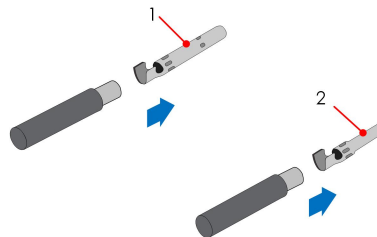

1: Positive crimp contact

2: Negative crimp contact

step 3 Lead the cable through cable gland, and insert the crimp contact into the insulator until it snaps into place. Gently pull the cable backward to ensure firm connection. Tighten the cable gland and the insulator (torque 2.5 N.m to 3 N.m).

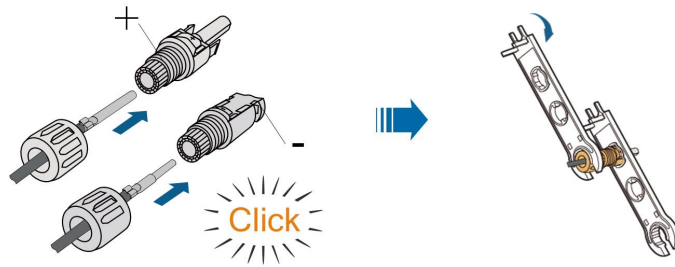

step 4 Check for polarity correctness.

NOTICE

If the PV polarity is reversed, the inverter will be in a fault or alarm state and will not operate normally.

-- End

6.7.3 Installing the PV Connector

step 1 Rotate the DC switch to "OFF" position.

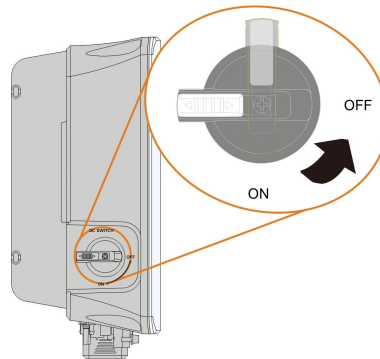

S006-E032

step 2 Check the cable connection of the PV string for polarity correctness and ensure that the open circuit voltage in any case does not exceed the inverter input limit of 600V.

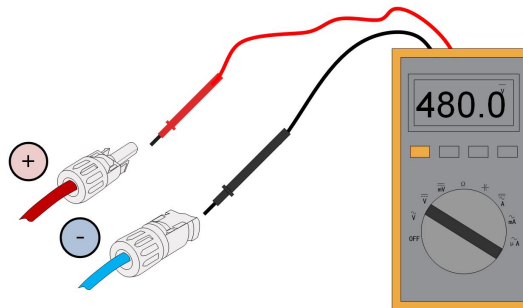

step 3 Connect the PV connectors to corresponding terminals until there is an audible click.

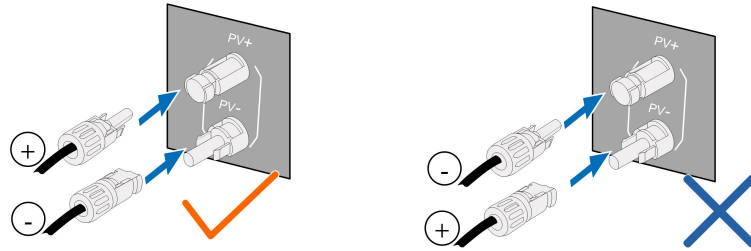
**NOTICE**

- **Check the positive and negative polarity of the PV strings, and connect the PV connectors to corresponding terminals only after ensuring polarity correctness.**
- **Arc or contactor over-temperature may occur if the PV connectors are not firmly connected in place, and SUNGROW shall not be held liable for any damage caused due to this operation.**

step 4 Follow the foregoing steps to connect PV connectors of other PV strings.

step 5 Seal any unused PV terminal with a terminal cap.

NOTICE

If the DC input is connected inversely and the DC switch has been rotated to "ON", do not operate immediately. Otherwise, the equipment may be damaged. Please turn the DC switch to "OFF" and remove the DC connector to adjust the polarity of the strings when the string current is lower than 0.5A.

-- End

6.8 Emergency Load Connection (Backup)

NOTICE

Risk of inverter damage due to incorrect cable connection. Do not connect the grid power wires to BACKUP port.



Do not short-circuit the Backup port during operation. Otherwise, the inverter or power distribution system will be seriously damaged. The loss is not covered by the SUNGROW warranty.

step 1 Unscrew the swivel nut of the AC connector.

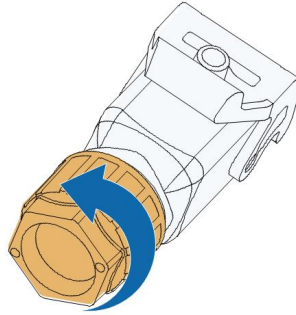

S000-E047

step 2 Thread the AC cable of appropriate length through the swivel nut, the sealing ring and the housing.

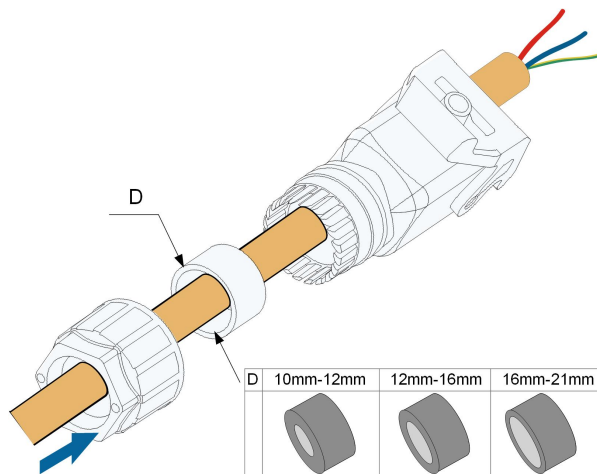

S000-E049

step 3 Remove the cable jacket by less than 45 mm, and strip the wire insulation by 12 mm–16 mm.

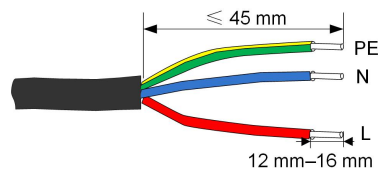

S000-E050

step 4 Open the clamp on the spring-loaded terminal and fully insert the wires into the corresponding holes. Then close the clamp and push the terminal plug into the housing until there is an audible click.

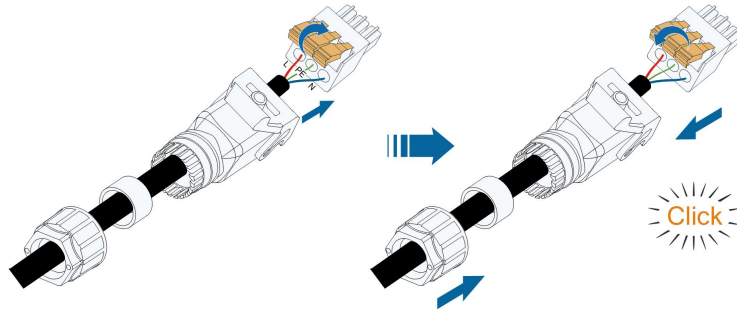

S000-E051

NOTICE

Observe the plug assignment.

- **Do not connect the L line to the "PE" terminal or the PE wire to the "N" terminal. Otherwise, unrecoverable damage to the inverter may follow.**
- **Do not connect the L line and the N line in reverse, otherwise the inverter may not operate normally.**

step 5 Ensure that the wires are securely in place by slightly pulling them. Tighten the swivel nut to the housing.

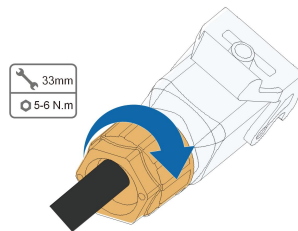

S000-E052

step 6 Remove the waterproof lid from the **BACKUP** terminal.

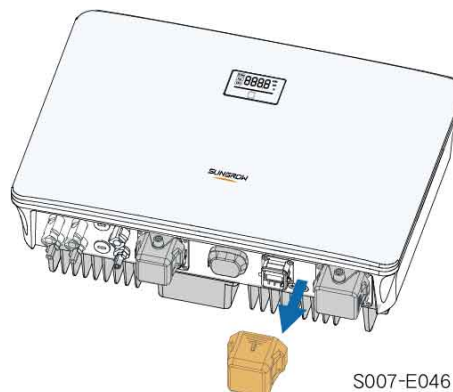

S007-E046

step 7 Lift the locking part upwards and insert the AC connector into the **BACKUP** terminal on the bottom side of the inverter. Then press the locking part and lock it with the screw.

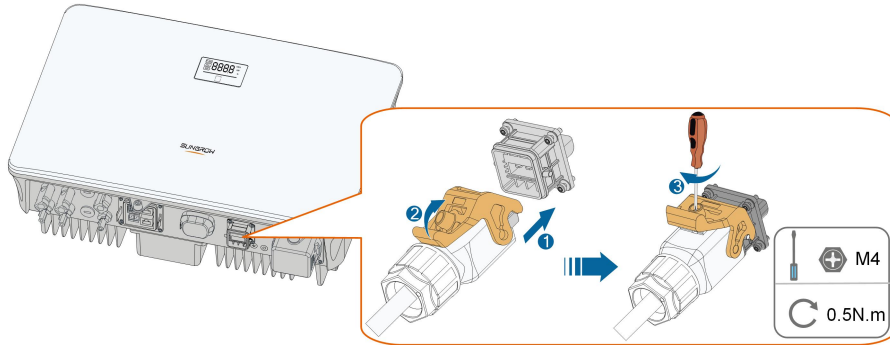

S007-E023

step 8 Connect the other ends to the emergency loads. Pull all the lines outward lightly to check whether they are firmly installed.

-- End

6.9 Battery Connection

This section mainly describes the cable connections on the inverter side. Refer to the instructions supplied by the battery manufacturer for the connections on the battery side and configuration.

⚠ WARNING

Only use properly insulated tools to prevent accidental electric shock or short circuits. If insulated tools are not available, use electrical tape to cover the entire exposed metal surfaces of the available tools except their tips.

⚠ WARNING

The plug connector must be connected only by trained electricians.

⚠ WARNING

Do not disconnect under load!
Battery connectors must not be disconnected while under load. They can be placed in a no load state by shutting down the inverter completely.



The hybrid inverter is not connected to a battery and does not support off-grid operation functions.

6.9.1 Connecting the Power Cable

A fuse with the specification of 150 V / 125 A (type: Bussmann BS88 125LET) is integrated to the **BAT-** terminal.

NOTICE

A two-pole DC circuit breaker with overcurrent protection (voltage rating not less than 100 V and current rating not less than 100 A) should be installed between the inverter and the battery.

If the battery is integrated with a readily accessible internal DC breaker, no additional DC breaker is required.

All power cables are equipped with water-proof direct plug-in connectors, which match the battery terminals at the bottom of the inverter.

6.9.1.1 Assembling the SUNCLIX Connector**NOTICE**

During assembly, be careful not to contaminate, pull out, or shift, the seal in the cable gland. A contaminated or shifted seal impairs strain relief and leak tightness.

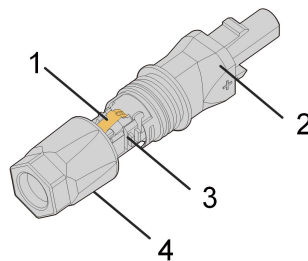

figure 6-4 SUNCLIX Connector Components

1: Spring

2: Sleeve

3: Insert

4: Cable gland

step 1 Strip the insulation from the cable by 15 mm.

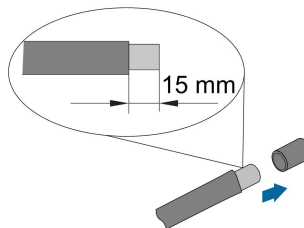

step 2 Pry the connection open and pull the sleeve and the insert apart.

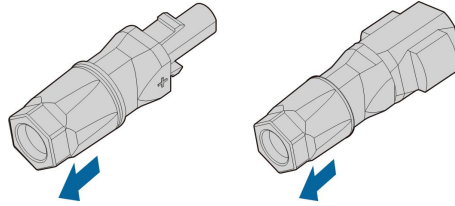

step 3 Insert the stripped cable into the cable gland up to the stop. The stranded wire can be seen inside the spring. Press the spring down until it audibly snaps into place.

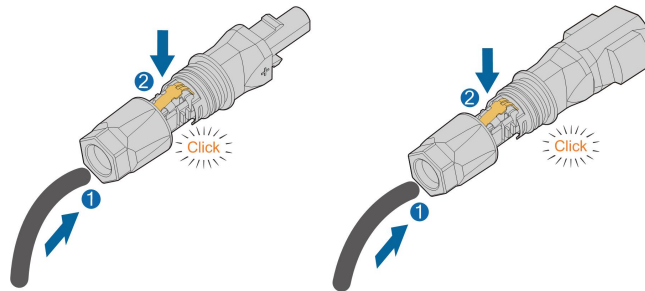

step 4 Push the insert into the sleeve and tighten the cable gland (torque 2 N·m).

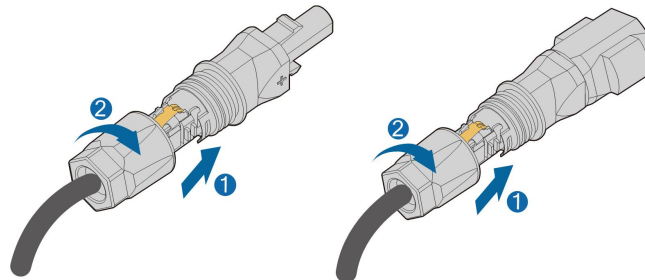

-- End

6.9.1.2 Installing the SUNCLIX Connector

NOTICE

Only connect these connectors with other SUNCLIX connectors. When making the connections, always observe the specifications regarding nominal voltage and nominal current. The smallest common value is permissible.

step 1 Plug the connectors into **PV4+/BAT+** and **PV4-/BAT-** terminals.

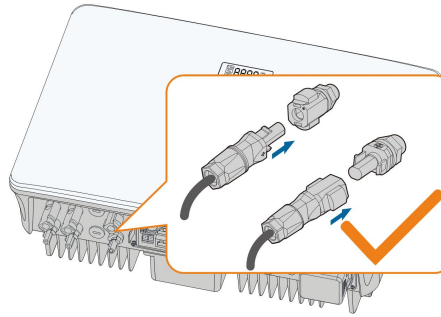

S007-E024

step 2 Ensure that the connectors are securely in place.

-- End

6.9.2 Connecting the CAN Cable

The CAN cable enables the communication between the inverter and the Li-ion battery from SUNGROW and BYD.

- Pin terminal connection

Refer to the section "[6.11 Meter Connection](#)" for details. Plug the wires into the **H** and **L** terminals according to the labels on the bottom of the inverter.

- RJ45 connection

Refer to the section "[6.13 DRM Connection](#)" for details. Plug the wires into the **RJ45-CAN** terminal on the bottom of the inverter.

6.9.3 Connecting the Enable Cable

The Enable cable along with the RS485 cable, are used for communication between the inverter and the Li-ion battery from LG Chem.

For detailed connection description of the RS485 cable, refer to the section "[6.12 RS485 Connection](#)".

For detailed connection description of the Enable cable, refer to the section "[6.11 Meter Connection](#)". Plug the wires into the **EN_H** and **EN_G** terminals according to the labels on the bottom of the inverter.

6.10 WiNet-S Connection

The WiNet-S module supports Ethernet communication and WLAN communication. It is not recommended to use both communication methods at the same time.

For details, see the quick guide for the WiNet-S module. Scan the following QR code for the quick guide.



6.10.1 Ethernet Communication

step 1 **(Optional)** Strip the insulation layer of the communication cable with an Ethernet wire stripper, and lead the corresponding signal cables out. Insert the stripped communication cable into the RJ45 plug in the correct order, and crimp it with a crimper.

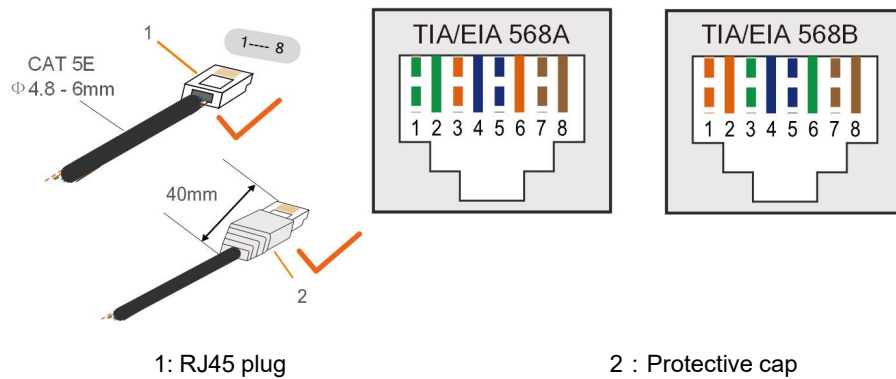

Skip this step if a standard network cable with RJ45 plug is prepared.

step 2 Unscrew the swivel nut from the communication module and take out the inner sealing ring.

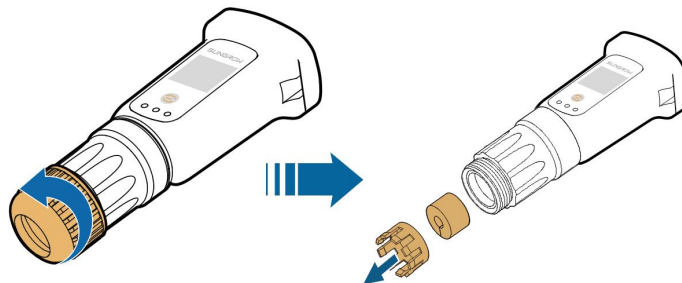

step 3 Unscrew the housing from the communication module.

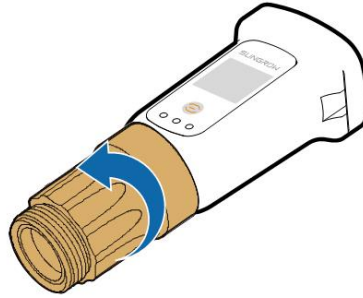

step 4 Thread the network cable through the swivel nut and gasket. Afterwards, route the cable into the opening of the sealing. Finally, insert the cable through the housing.

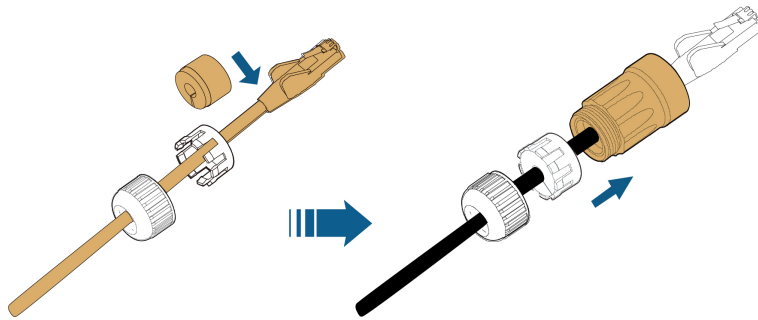

step 5 Insert the RJ45 plug into the front plug connector until there is an audible click and tighten the housing. Install the gasket and fasten the swivel nut.

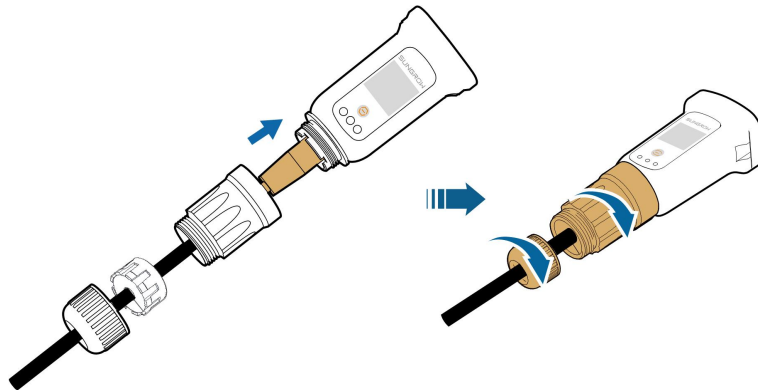

step 6 Remove the waterproof lid from the **COM1** terminal and install WiNet-S.

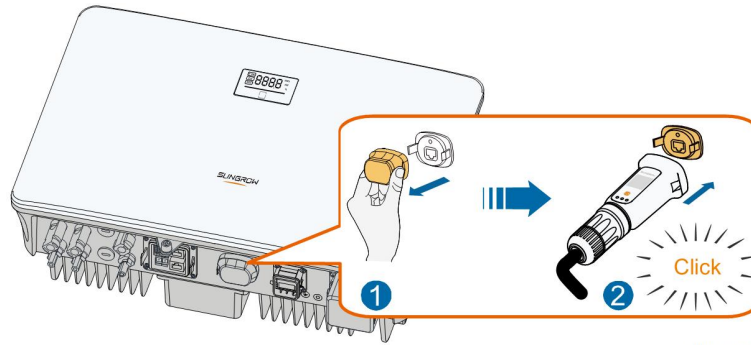

S007-E041

step 7 Slightly shake it by hand to determine whether it is installed firmly.

-- End

6.10.2 WLAN Communication

step 1 Remove the waterproof lid from the **COM1** terminal.

step 2 Install the module. Slightly shake it by hand to determine whether it is installed firmly, as shown below.

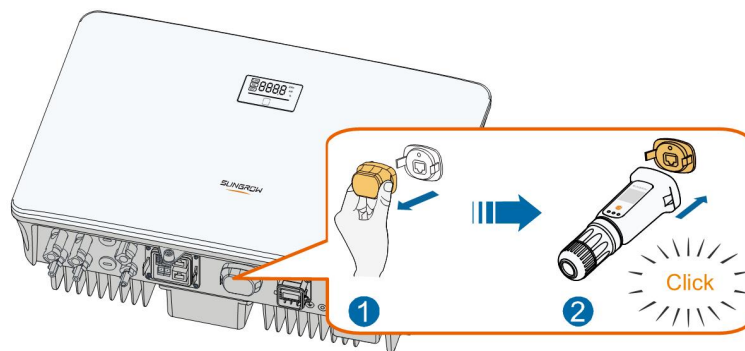

S007-E042

step 3 Refer to the guide delivered with the module for the set-up.

-- End

6.11 Meter Connection

step 1 Remove the cable jacket and strip the wire insulation.

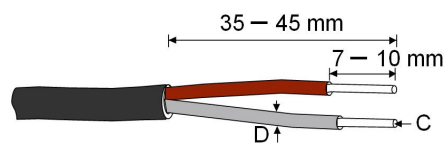

$C = 0.5 - 1.0 \text{ mm}^2$ $D \leq 2.8 \text{ mm}$

S007-E044

step 2 (Optional) When using a multi-strand wire cable, connect the wire head to the cord end terminal. In case of single-strand copper wire, skip this step.

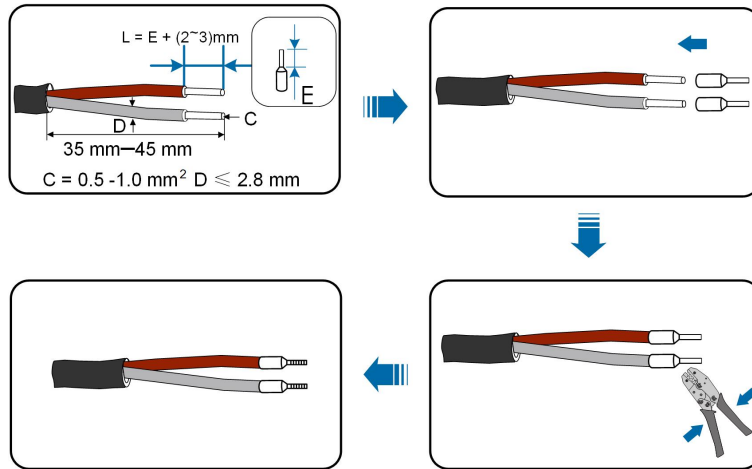

S007-E045

step 3 Unscrew the swivel nut from the connector.

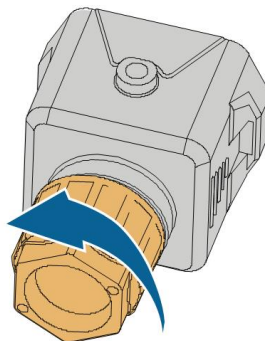

S006-E011

step 4 Remove the seal and route the cable into the opening of the sealing.

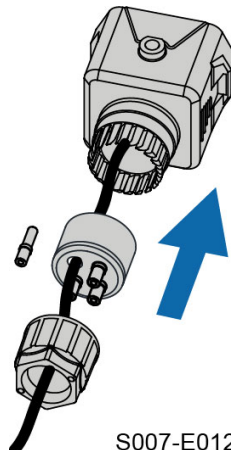

S007-E012

step 5 Plug the wires into the corresponding terminals as shown in the following figure. Ensure that the wires are securely in place by slightly pulling them.

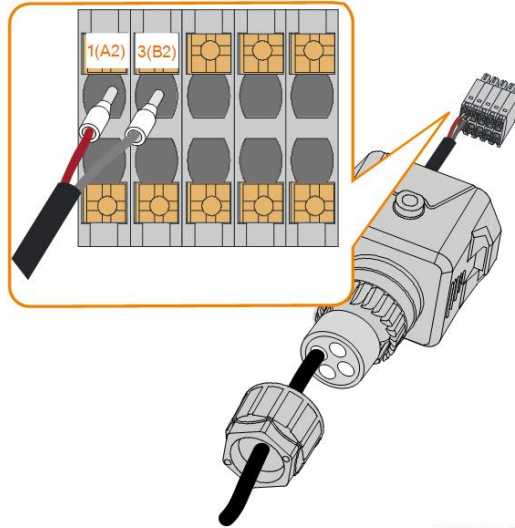

S006-E013

step 6 Remove the waterproof lid from the **COM2** terminal.

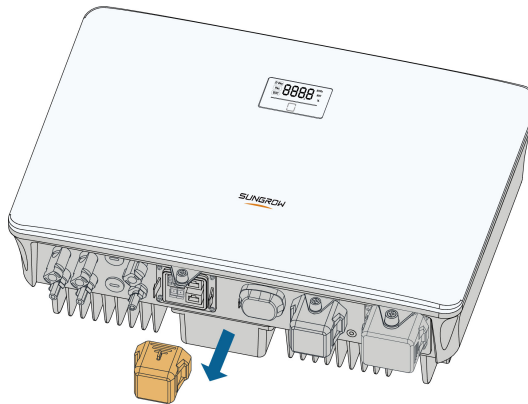

S007-E013

step 7 Insert the terminal plug into the **COM2** terminal at the bottom side of the inverter and then install the housing.

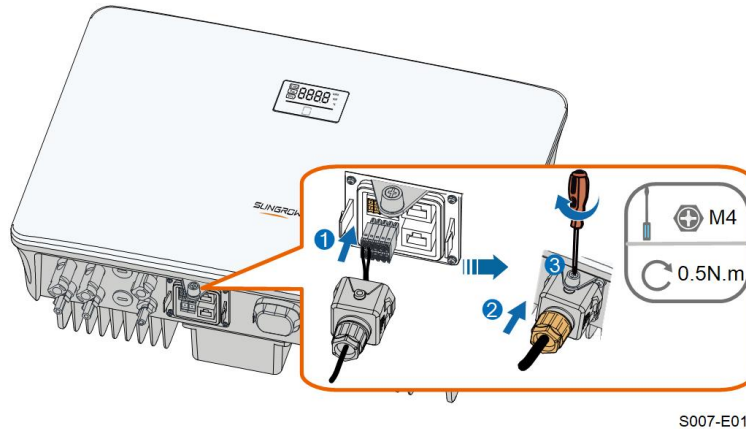

step 8 Slightly pull out the cable and then fasten the swivel nut. Lock the connector with the screw.

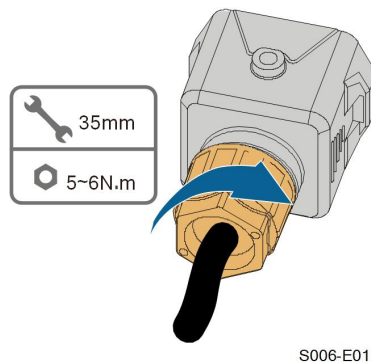

-- End

6.12 RS485 Connection

The RS485 connection is reserved for inverter daisy chain. The availability will be updated in the upcoming manual version.

For detailed connection description, refer to the section "[6.11 Meter Connection](#)". Plug the wires into the **A1** and **B1** terminals according to the labels on the bottom of the inverter.

6.13 DRM Connection

DRM and Ripple Control support only one function at the same time.

DRM

In Australia and New Zealand, the inverter supports the demand response modes as specified in the standard AS/NZS 4777.

The following figure shows the wiring between the inverter and the external DRED.

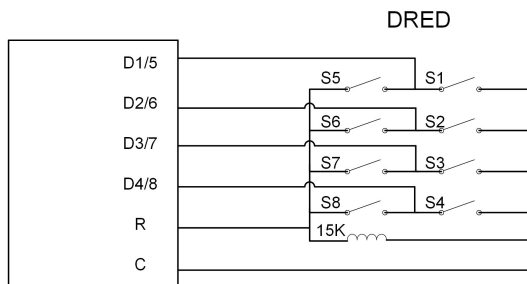

table 6-4 Method of Asserting DRM

Mode	Asserted by Shorting Terminals on Inverter	Switch Operation on External DRED
DRM0	R & C	Close S1 and S5
DRM1	D1/5 & C	Close S1
DRM2	D2/6 & C	Close S2
DRM3	D3/7 & C	Close S3
DRM4	D4/8 & C	Close S4
DRM5	D1/5 & R	Close S5
DRM6	D2/6 & R	Close S6
DRM7	D3/7 & R	Close S7
DRM8	D4/8 & R	Close S8

Ripple Control

In Germany, the grid company uses the Ripple Control Receiver to convert the grid dispatching signal and send it as a dry contact signal.

Wiring of the ripple control receiver dry contact cables is shown in the figure below:

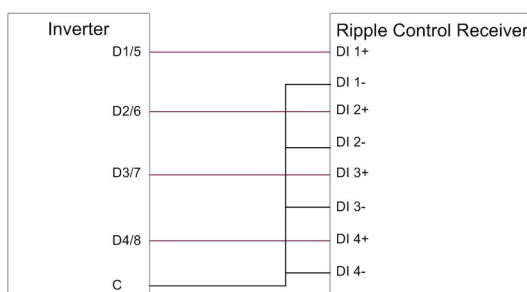

- step 1 **(Optional)** Strip the insulation layer of the communication cable with an Ethernet wire stripper, and lead the corresponding signal cables out. Insert the stripped communication cable into the RJ45 plug in the correct order, and crimp it with a crimper.

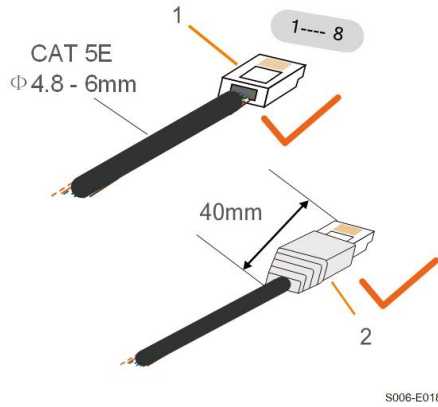

1: RJ45 plug

2 : Protective cap

i Skip this step if a standard network cable with RJ45 plug is prepared.

step 2 Unscrew the swivel nut from the connector.

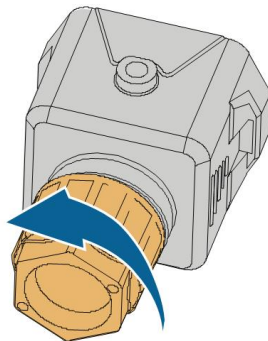

S006-E011

step 3 Remove the seal.

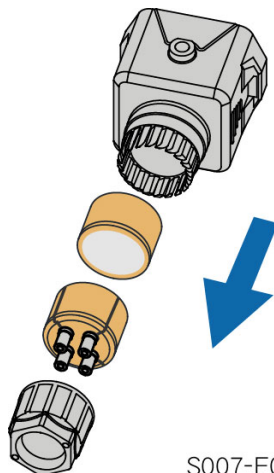

S007-E047

step 4 Lead the cable through the cable gland.

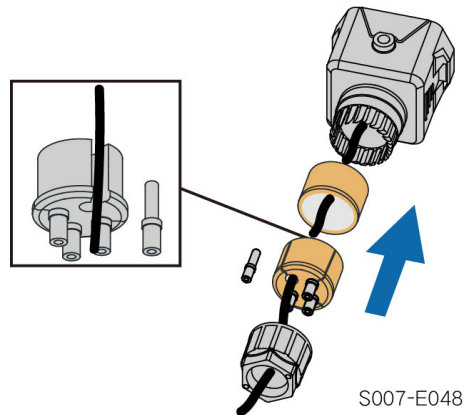

step 5 Plug the wires into the corresponding terminals as shown in the following figure. Ensure that the wires are securely in place by slightly pulling them.

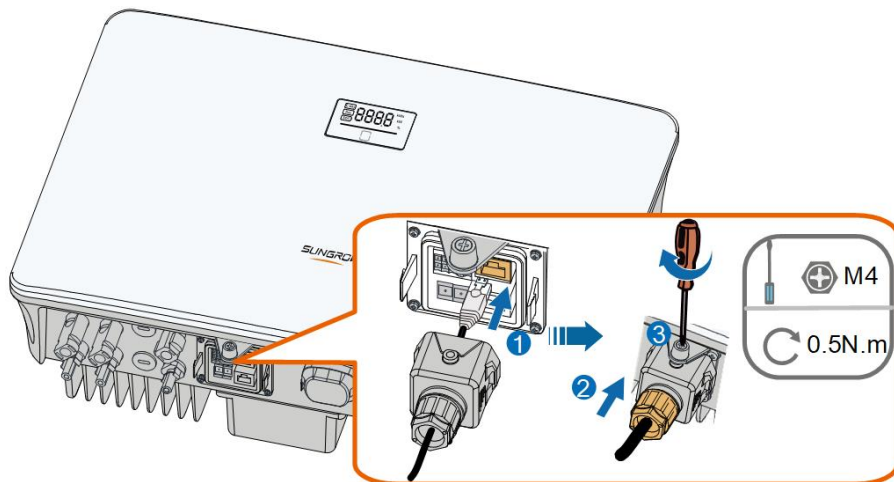

step 6 Slightly pull out the cable and then fasten the swivel nut. Lock the connector with the screw.

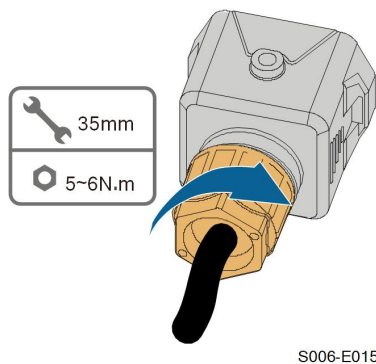

-- End

7 Commissioning

7.1 Inspection before Commissioning

Check the following items before starting the inverter:

- All equipment has been reliably installed.
- DC switch(es) and AC circuit breaker are in the "OFF" position.
- The ground cable is properly and reliably connected.
- The AC cable is properly and reliably connected.
- The DC cable is properly and reliably connected.
- The communication cable is properly and reliably connected.
- The vacant terminals are sealed.
- No foreign items, such as tools, are left on the top of the machine or in the junction box (if there is).
- The AC circuit breaker is selected in accordance with the requirements of this manual and local standards.
- All warning signs & labels are intact and legible.

7.2 Powering on the System

If all of the items mentioned above meet the requirements, proceed as follows to start up the inverter for the first time.

- step 1 Turn on the AC circuit breaker between the inverter and the grid.
- step 2 (Optional) Connect the external DC circuit breaker between the inverter and the battery pack if a battery is equipped.
- step 3 (Optional) Power on the battery pack manually if a battery is equipped.
- step 4 Rotate the DC switch of the inverter to "ON" position.
- step 5 If the irradiation and grid conditions meet requirements, the inverter will operate normally. Observe the LED indicator to ensure that the inverter operates normally. Refer to ["2.4 LED Panel"](#) for LED screen introduction and LED indicator definition.
- step 6 Refer to the quick guide for WiNet-S for its indicator definition.

-- End

7.3 App Preparation

- step 1 Install the iSolarCloud App with latest version. Refer to "8.2 Installing the App".
- step 2 Register an account. Refer to "8.3 Account Registration". If you have got the account and password from the distributor/installer or SUNGROW, skip this step.
- step 3 Download the firmware package to the mobile device in advance. Refer to "Firmware Update". This is to avoid download failure due to poor on-site network signal.

-- End

7.4 Creating a Plant

Screenshots of creating a plant are for reference only. For details, refer to the actual screen.

- step 1 Open the App, tap  at the upper right corner and tap **Select Server**. Choose the same server as when registering.

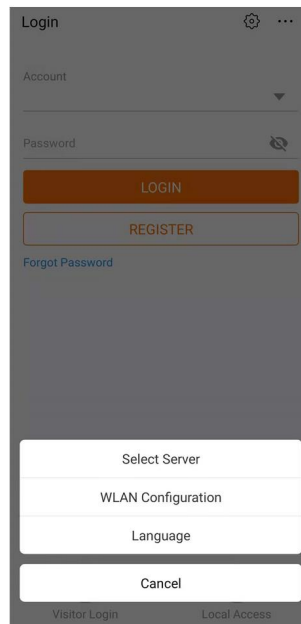

figure 7-1 Selecting the Server

- step 2 Enter the account and password on the login screen and tap **Login** to enter the App home screen.
- step 3 Tap the icon  at the upper right corner to enter the creating screen.



figure 7-2 Creating Power Plant

step 4 Select plant type to **RESIDENTIAL** and inverter type to **HYBRID**.

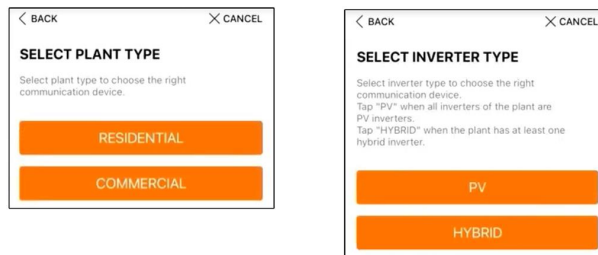

figure 7-3 Selecting Plant/Inverter Type

step 5 Scan the QR code on the communication device or manually enter the serial number of the communication device. Tap **Next** after the QR code is identified or the serial number entered is correct and then tap **CONFIRM**. Your mobile device is thus connected to the WiNet-S successfully.

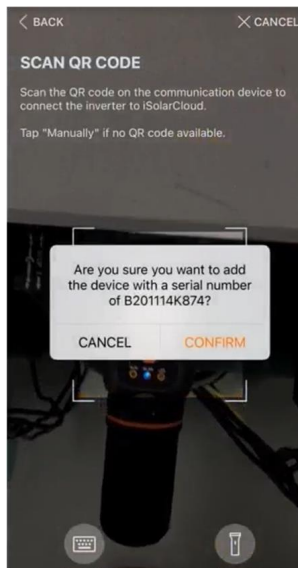

figure 7-4 Connecting Mobile Device to WiNet-S

step 6 Select the Internet access mode to **WLAN** or **ETHERNET** according to actual connection. The following description is for WLAN access mode.



figure 7-5 Selecting Internet Access Mode

step 7 The **EASYCONNECT INSTRUCTION** screen will prompt. Press the multi-function button on the WiNet-S module once to turn on EasyConnect mode. The WLAN indicator on WiNet-S blinks quickly when this mode is turned on. Return to the App and the screen displays successful connection to the inverter WLAN. Tap **NEXT**.

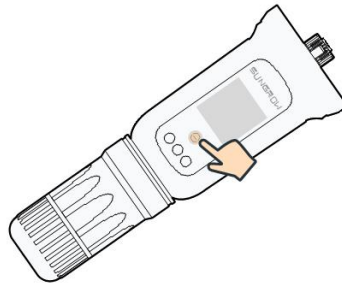

figure 7-6 Turn on EasyConnect Mode

NOTICE

**The EasyConnect mode can be used only when the router is 2.4 GHz.
If the EasyConnect mode fails, refer to the WiNet-S quick guide for the instructions of other modes.**

step 8 Connect the inverter to router network. Enter network name and password. Tap **NEXT** and the screen display prompt information of successful connection to the router network.

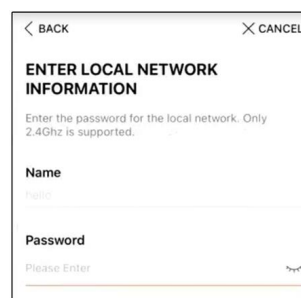

figure 7-7 Connecting Inverter to Router Network

-- End

7.5 Initializing the Device

The inverter is successfully connected to the router.

If there is no latest equipment upgrade package, skip steps 1 and 2.

The actual initializing procedure may differ due to different countries. Please follow the actual App guidance.

- step 1 If a latest equipment upgrade package is available, the following prompt window pops up. Tap **UPDATE NOW** to download the latest update package.

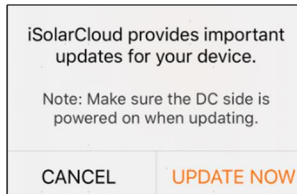

figure 7-8 Upgrade Reminder

- step 2 After download, it would take around 15 minutes to update. After successful upgrade, the screen will show the version numbers before and after the upgrade as well as the upgrade time. Tap **NEXT**.

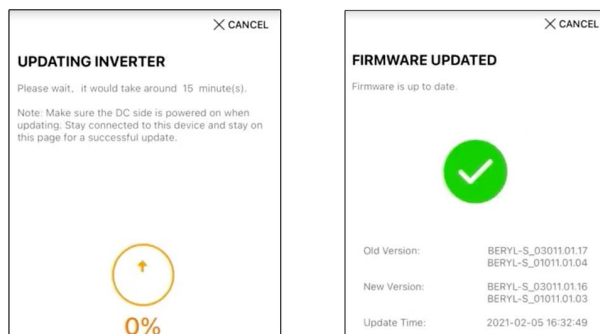

figure 7-9 Upgrading Inverter

NOTICE

If the communication equipment is upgraded, after successful upgrade, check and confirm that the phone is connected to the inverter WLAN.

- step 3 Tap **Country/Region** and select the country where the inverter is installed at.

NOTICE

The parameter Country/Region must be set to the country (region) where the inverter is installed at. Otherwise, the inverter may report errors.

- step 4 Initialize parameters according to local grid requirements, including grid type, reactive power regulation mode, etc. The screen displays that the inverter is successfully configured.

Country/Region	Germany	>
Grid Type	Low Voltage	>
Installed PV Power	20.00 kWp	
Feed-in Limitation	<input checked="" type="checkbox"/>	
Feed-in Limitation Value	14.00 kW	
Feed-in Limitation Ratio	70.0 %	
Rated Power of Original Power Generation Systems	0.00 kW	
Reactive Power Regulation Mode	Off	>
Reactive Power Ratio	0.0 %	
Device Address	1	
NEXT		

figure 7-10 Initializing Parameters

-- End

7.6 Configuring the Plant

The inverter is successfully added to the plant and initialized. Refer to the guidance in previous sections.

The distributor/installer who creates a plant for the end user needs to get the end user's e-mail address. In configuring a plant, the e-mail address is required, and each e-mail address can be registered only once.

step 1 The App screen will display the added inverter. Tap **NEXT** to configure the plant.

✕ CANCEL

ADD INVERTER

Tap "NEXT" to start configuration of the plant or tap "Add More" to add more inverters.

B201114K874

+

Add More

figure 7-11 Display the Added Inverter

step 2 Fill in the plant information. The fields marked with * must be filled in.

figure 7-12 Entering Plant Information

step 3 **(Optional)** Fill in the tariff information. The electricity price can be set to a specific value or Time-of-Use tariff.

figure 7-13 Entering Tariff Information

step 4 Fill in the end user's e-mail address. The first time you fill in the end user's e-mail address, the system will create an account for the end user and send an email to the end user. The end user can activate the account via the email.



The Distributor/installer creates plants for the end user and can manage the plants by default.

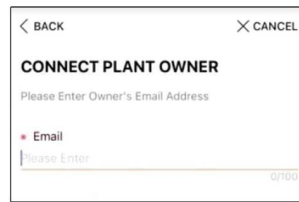

figure 7-14 Entering Owner's e-mail

step 5 Tap **NEXT** to wait for the inverter to connect to the iSolarCloud.

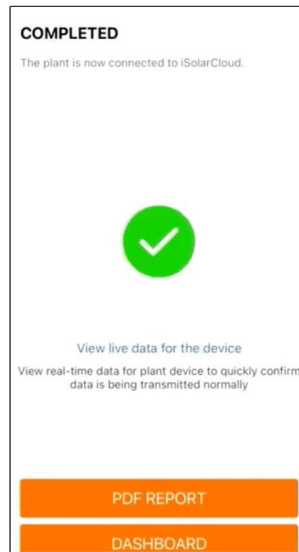

figure 7-15 Configuration Completed

step 6 **(Optional)** Tab **View live data for the device**, tick **Inverter** or **Total Plant Devices** and tab **ALL PLANTS OPEN**. The clock symbol indicates that the live data view function is successfully enabled. Tab the inverter to view the live data about voltage, current, power or curve.



Contact Sungrow service to enable live data function of devices. Once enabled, live data function is available for 3 hours per day by default. To make it available for 24 hours, contact SUNGROW.

step 7 Tab **BACK** to the **COMPLETED** screen. Tab **PDF REPORT** to export the plant configuration report.

step 8 Tab **BACK** to the **COMPLETED** screen. Tab **DASHBOARD** to return and manually refresh the page until the newly created plant is displayed with status commissioned.

-- End

8 iSolarCloud App

8.1 Brief Introduction

The iSolarCloud App can establish communication connection to the inverter via the WLAN, providing remote monitoring, data logging and near-end maintenance on the inverter. Users can also view inverter information and set parameters through the App.

* To achieve direct login via WLAN, the wireless communication module developed and manufactured by SUNGROW is required. The iSolarCloud App can also establish communication connection to the inverter via Ethernet connection.



- This manual describes only how to achieve near-end maintenance via WLAN direct connection.
- Screenshots in this manual are based on the V2.1.6 App for Android system, and the actual interfaces may differ.

8.2 Installing the App

Method 1

Download and install the App through the following application stores:

- MyApp (Android, mainland China users)
- Google Play (Android, users other than mainland China ones)
- App Store (iOS)

Method 2

Scan the following QR code to download and install the App according to the prompt information.



The App icon appears on the home screen after installation.



8.3 Account Registration

The account distinguishes two user groups, end user and distributor/installer.

- The end user can view plant information, create plants, set parameters, share plants, etc.
- The distributor/installer can help the end user to create plants, manage, install, or maintain plants, and manage users and organizations.

step 1 Tap **REGISTER** to enter the registration screen.

USER REGISTRATION

Account Type

BASE Plant

Please select the relevant server for your area; if not available, please select the international station

Distributor/Installer

Distributor/Installer is the person who install or/and manage the plant, and supply service to end user

End User

End User is the person who will own or has owned one inverter or more

step 2 Select the relevant server for your area.

step 3 Select **End user** or **Distributor/Installer** to enter the corresponding screen.

DISTRIBUTOR/INSTALLER

Email @gmail.com *

[Send Verification Code](#)

Verification Code *

Password *

Confirm Password *

Country/Region *

Company Name

Code of Upper Level Installer/Distributor

[Accept Privacy Policy](#)

- step 4 Fill in the registration information, including email, verification code, password and affirmation and country (region). The distributor/installer has the permission to fill in the company name and the code of upper level distributor/installer.



The code of upper level distributor/installer can be obtained from the upper level distributor/installer. Only when your organization belongs to the upper level distributor/installer organization, can you fill in the corresponding code.

- step 5 Tick **Accept privacy protocol** and tap **Register** to finish the registration operation.

-- End

8.4 Login

8.4.1 Requirements

The following requirements should be met:

- The AC or DC side of the inverter is powered-on.
- The WLAN function of the mobile phone is enabled.
- The mobile phone is within the coverage of the wireless network produced by the communication module.

8.4.2 Login Procedure

- step 1 For the WiNet-S module, press the multi-function button 3 times to enable the WLAN hotspot. No password is required and the valid time is 30 minutes.

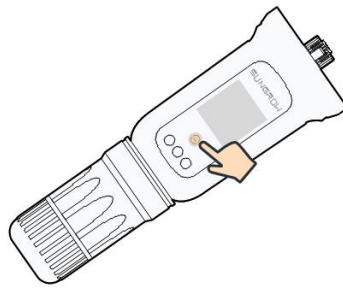

figure 8-1 Enabling the WLAN Hotspot

step 2 Connect the mobile phone to the WLAN network named as "SG-xxxxxxxxxx" (xxxxxxxxxx is the serial number indicated on the side of the communication module).

step 3 Open the App to enter the login screen. Tap **Local Access** to enter the next screen.

step 4 Select **WLAN** and select the device (SN), then enter the password and tap **LOGIN**.



- If the WiFi signal, serial number or inverter related data information cannot be found, unplug and reinsert the Winet-S or press the multi-function button of the Winet-S three times.
- The default account is "user" and the initial password is "pw1111" which should be changed for the consideration of account security. Tap "More" at the lower right corner on home page and choose "Change Password".

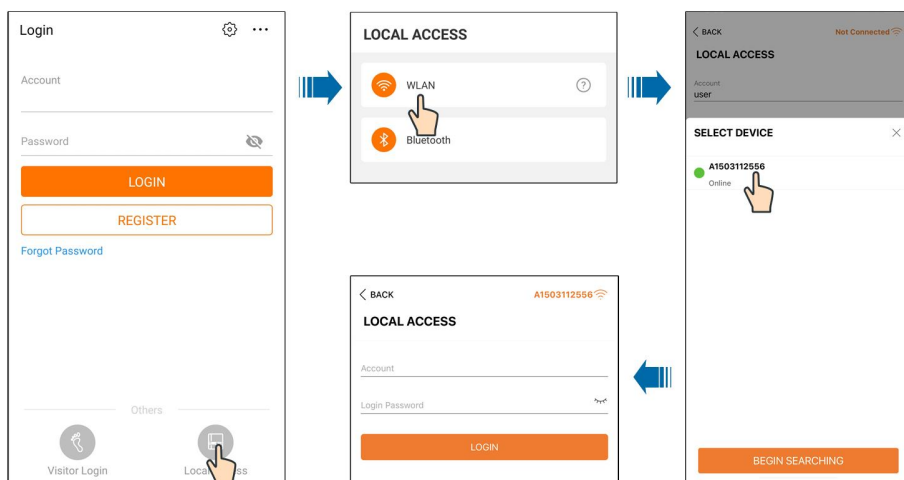

figure 8-2 WLAN Local Access

step 5 If the inverter is not initialized, navigate to the quick setting screen to initialize the protection parameters. For details, please refer to "**Initial Settings**".

NOTICE

The "Country/Region" must be set to the country where the inverter is installed at. Otherwise, the inverter may report errors.

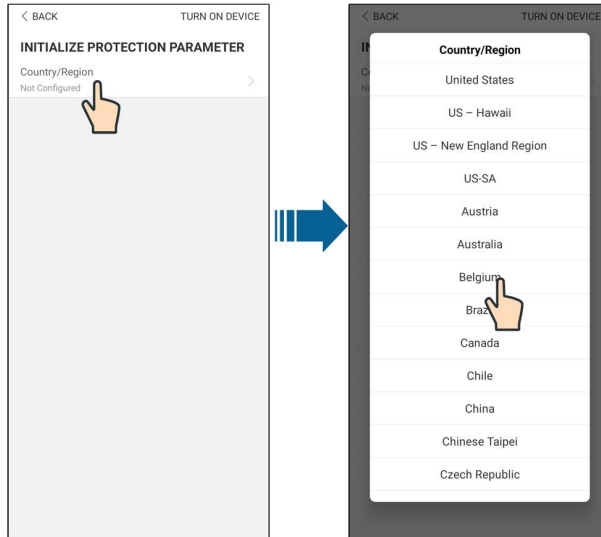

figure 8-3 WLAN Local Access

- step 6 After finishing the settings, tap **TURN ON DEVICE** at the upper right corner and the device will be initialized. The App will send start instructions and the device will start and operate.
- step 7 After initialization settings, the App will return automatically to the home page.

- - End

8.5 Initial Settings

8.5.1 Feed-in Limitation

The function of the feed-in limitation is to control the amount of power injected in the grid by the plant. In some situations, this function is also called as **Export limitation** or **Zero export**. The feed-in limitation function requires the using of Smart Energy Meter. Without the Smart Energy Meter, the feed-in limitation function will be unavailable.

table 8-1 Description of feed-in limitation parameters

Parameter	Default value	Range
Feed-in Limitation	Off	On / Off
Feed-in Limitation Value	Rated power	0 ~ Rated power
Feed-in Limitation Ratio	100.0%	0 ~ 100%
Rated Power of Original Power Generation Systems	Depends on inverter power of other companies	

8.5.2 Off-grid Mode

The off-grid mode is off by default, the user can set an amount of **Reserved Battery SOC for Off-Grid**. It is the minimum battery level in the on-grid state and will be supplied to the Backup loads in case of grid blackout.

8.6 Function Overview

The App provides parameter viewing and setting functions, as shown in the following figure.

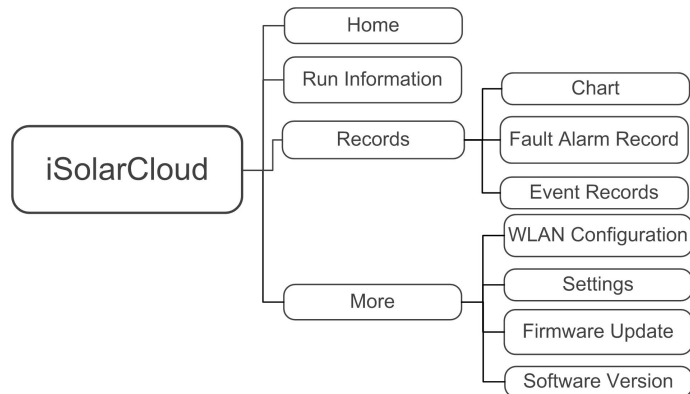

figure 8-4 App Function Tree Map

8.7 Home

Home page of the App is shown in the following figure.

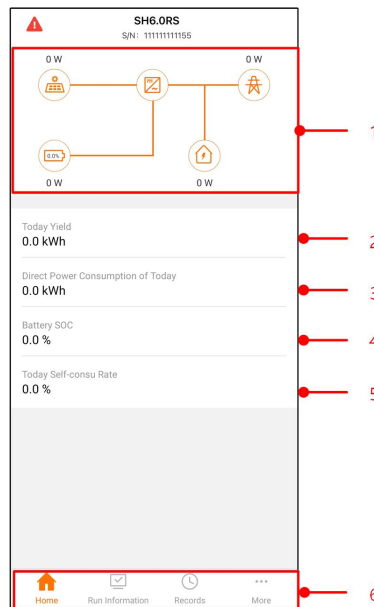



figure 8-5 Home

table 8-2 Home page description

No.	Name	Description
1	Load flow chart	Shows the PV power generation power, feed-in power, etc. The line with an arrow indicates energy flow between connected devices, and the arrow pointing indicates energy flow direction.
2	Today yield	Shows today power generation of the inverter
3	Direct Power Consumption of Today	Shows electricity directly consumed by loads today
4	Battery SOC	Indicates remaining battery capacity
5	Today Self-consumption Rate	Indicates today self-consumption rate of the PV system
6	Navigation bar	Includes menus of Home , Run Information , Records , and More .

If the inverter runs abnormally, the fault icon  appears on the upper left corner of the screen. Users can tap the icon to view detailed fault information and corrective measures.

8.8 Run Information

Tap **Run Information** on the navigation bar to enter the corresponding screen, as shown in the following figure.

RUN INFORMATION	
PV Information ^	
String 1 Voltage	0.0 V
String 1 Current	0.00 A
String 2 Voltage	0.0 V
String 2 Current	0.00 A
Daily PV Yield	0.0 kWh
Total PV Yield	0.0 kWh
Inverter Information ^	
Running Status	Shut Down
Bus Voltage	0.0 V
Internal Air Temperature	24.9 °C
Array Insulation Resistance	0 kΩ
Country (Region) Information	Germany
Ripple Control state	No RIPP Schedule
Power Limitation Mode	Unlimited Power

figure 8-6 Run Information

The run information includes the PV information, inverter information, input, output, grid information, load information, and battery information.

8.9 Records

Tap **Records** on the navigation bar to enter the screen, as shown in the following figure.

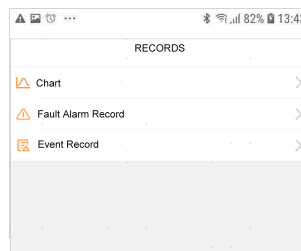

figure 8-7 Records

On **Records** screen, users can view chart and check fault alarm record.

8.9.1 Chart

Tap **Chart** to enter the screen showing daily power generation, as shown in the following figure.

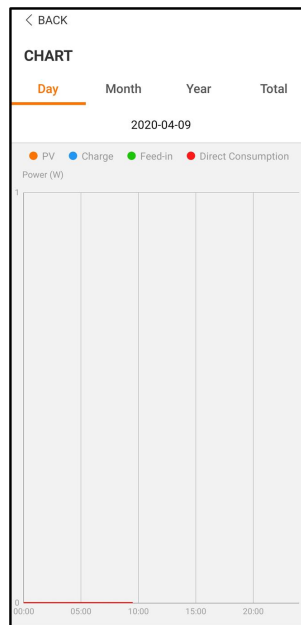

figure 8-8 Power Curve

The App displays power generation records in a variety of forms, including daily power generation graph, monthly power generation histogram, annual power generation histogram, and total power generation histogram.

table 8-3 Description of power generation records

Item	Description
Daily power generation graph	Indicates today power generation, charging, feed-in power, and direct consumption power
Monthly power generation histogram	Indicates monthly power generation, charging, feed-in power, and direct consumption power
Annual power generation histogram	Indicates annual power generation, charging, feed-in power, and direct consumption power
Total power generation histogram	Indicates total power generation, charging, feed-in power, and direct consumption power

8.9.2 Fault Alarm Record

Tap **Fault Alarm Record** to enter the screen, as shown in the following figure.

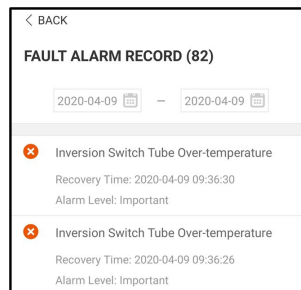

figure 8-9 Fault Alarm Record



Click "📅" to select a time segment and view corresponding records.

Select one of the records in the list and click the record, to view the detailed fault info as shown in following figure.

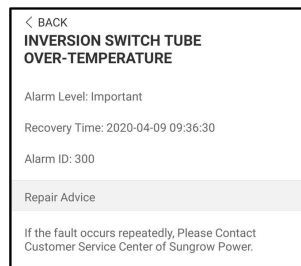

figure 8-10 Detailed fault alarm info

8.9.3 Event Record

Tap **Event Record** to enter the screen, as shown in the following figure.

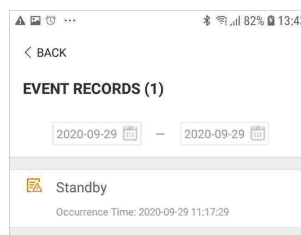

figure 8-11 Event Record



Click "📅" to select a time segment and view corresponding records.

8.10 More

Tap **More** on the navigation bar to enter the screen, as shown in the following figure.

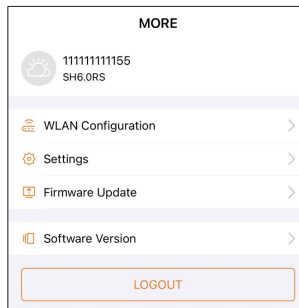
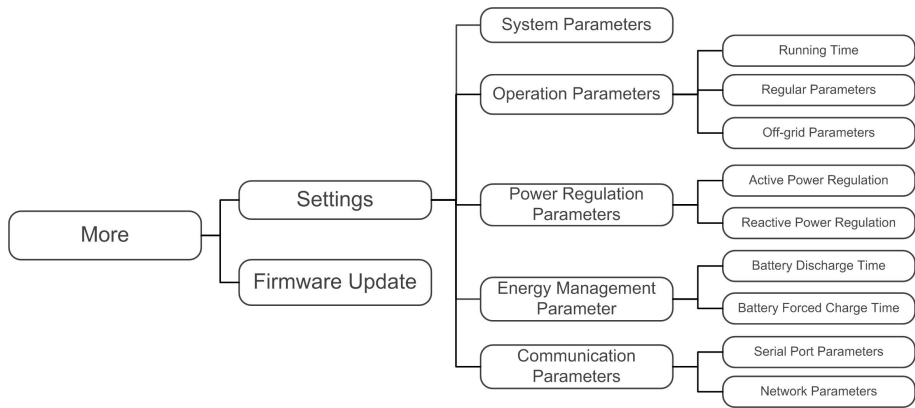

figure 8-12 More



The **More** screen supports the following operations:

- Set parameters including inverter system parameters and energy management parameter.
- Upgrade inverter firmware (ARM/DSP/PVD/CPLD).

8.10.1 System Parameters

Tap **Settings**→**System Parameters** to enter the corresponding screen, as shown in the following figure.

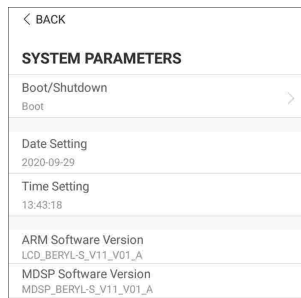

figure 8-13 System Parameters

Boot/Shutdown

Tap **Boot/Shutdown** to send the boot/shutdown instruction to the inverter.

For Australia and New Zealand, when the DRM state is DRM0, the "Boot" option will be prohibited.

Date/Time

The correct system time is very important. Wrong system time will directly affect the data logging and power generation value. The clock is in 24-hour format.

8.10.2 Running Time

Tap **Settings**→**Operation Parameters**→**Running Time** to enter the corresponding screen, on which you can set **Connecting Time** and **Reconnecting Time**.

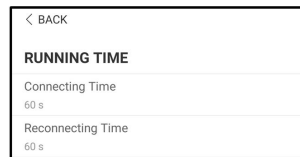

figure 8-14 Running Time

table 8-4 Description of running time parameters

Parameter	Explanation	Default	Range
Connecting Time	The time that the inverter takes to enter into the running mode from the standby mode in fault-free state	60s	20s ~ 900s
Reconnecting Time	The time that the inverter takes to recover from the fault state to normal state (the inverter is not running)	60s	0s ~ 3600s

8.10.3 Regular Parameters

Tap **Settings**→**Operation Parameters**→**Regular Parameters** to enter the screen, as shown in the following figure.

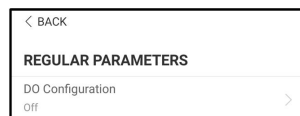

figure 8-15 Regular Parameters

After connecting the load to the DO terminals, a relay control signal will be transmitted. Users can flexibly set the control mode of DO configuration according to individual demand.

table 8-5 The control mode of DO configuration

Mode	Setting description
Off	-
Grounding Detection	See "8.10.11 Grounding Detection"

8.10.4 Off-grid Parameters

Tap **Settings**→**Operation Parameters**→**Off-grid Parameters** to enter the screen, as shown in the following figure.

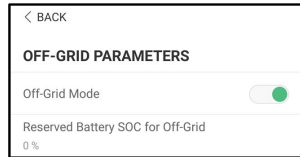

figure 8-16 Off-grid Parameters

Refer to the description in "[8.5.2 Off-grid Mode](#)".

8.10.5 Active Power Regulation

Tap **Settings**→**Power Regulation Parameters**→**Active Power Regulation** to enter the screen, as shown in the following figure.

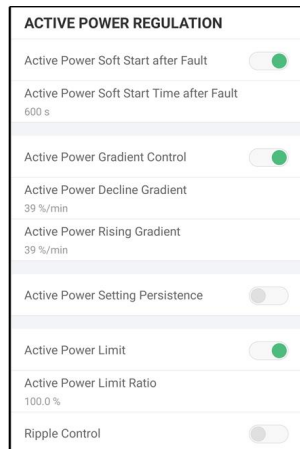

figure 8-17 Active Power Regulation

table 8-6 Description of active power regulation

Parameter	Description	Default	Range
Active Power Soft Start after Fault	Switch for activating/deactivating the function of active power soft start after a fault occurs	On	On/Off
Active Power Soft Start Time after Fault	The soft start time required for raising active power from 0 to rated value after a fault occurs	600s	1s ~ 1200s
Active Power Gradient Control	Set whether to enable active power gradient control	On	On/Off
Active Power Decline Gradient	Decline gradient of inverter active power per minute	39%/min	3%/min ~ 6000%/min
Active Power Rising Gradient	Rising gradient of inverter active power per minute		

Parameter	Description	Default	Range
Active Power Setting Persistence	Switch for activating/deactivating the function of active power setting persistence	Off	On/Off
Active Power Limit	Switch for limiting active power	On	On/Off
Active Power Limit Ratio	The ratio of active power limit to rated power in percentage	100.0%	0 ~ 100%
Ripple Control	Switch for Ripple Control	Off	On/Off

8.10.6 Reactive Power Regulation

Tap **Settings**→**Power Regulation Parameters**→**Reactive Power Regulation** to enter the screen, as shown in the following figure.

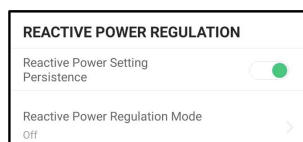

figure 8-18 Reactive Power Regulation

table 8-7 Description of reactive power regulation

Parameter	Description	Default	Range
Reactive Power Setting Persistence	Switch for activating/deactivating the function of reactive power setting persistence	On	On / Off
Reactive Power Regulation Mode	-	Off	Off / PF / Qt / Q(P) / Q(U)

table 8-8 Descriptions of reactive power regulation mode:

Mode	Descriptions
Off	The PF is fixed at +1.000.
PF	The reactive power can be regulated by the parameter PF (Power Factor).
Qt	The reactive power can be regulated by the parameter Q-Var limits (in %).
Q(P)	The PF changes with the output power of the inverter.
Q(U)	The reactive power changes with the grid voltage.

“Off” Mode

The reactive power regulation function is disabled. The PF is limited to +1.000.

“PF” Mode

The power factor is fixed and reactive power setpoint is calculated according to the current power. The PF ranges from 0.8 leading to 0.8 lagging.

Leading: the inverter is sourcing reactive power to the grid.

Lagging: the inverter is injecting reactive power into the grid.

“Qt” Mode

In the Qt mode, system rated reactive power is fixed, and the system injects reactive power according to the delivered reactive power ratio. The **Reactive Power Ratio** is set through the App.

The setting range of the reactive power ratio is 0~100% or 0~-100%, corresponding to the ranges of inductive and capacitive reactive power regulation respectively.

“Q(P)” Mode

The PF of the inverter output varies in response to the output power of the inverter.

table 8-9 “Q(P)” Mode Parameter Descriptions:

Parameter	Explanation	Range
Q(P) Curve	Select corresponding curve according to local regulations	A, B, C*
QP_P1	Output power at P1 on the Q(P) mode curve (in percentage)	10% ~ 100%
QP_P2	Output power at P2 on the Q(P) mode curve (in percentage)	20% ~ 100%
QP_P3	Output power at P3 on the Q(P) mode curve (in percentage)	20% ~ 100%
QP_K1	Power factor at P1 on the Q(P) mode curve	
QP_K2	Power factor at P2 on the Q(P) mode curve	Curve A/C: 0.8 ~ 1 Curve B: - 0.6 ~ 0.6
QP_K3	Power factor at P3 on the Q(P) mode curve	
QP_EnterVoltage	Voltage percentage for Q(P) function activation	100% ~ 110%
QP_ExitVoltage	Voltage percentage for Q(P) function deactivation	90% ~ 100%
QP_ExitPower	Power percentage for Q(P) function deactivation	1% ~ 20%
QP_EnableMode	Unconditional activation/deactivation of Q (P) function	Yes / No

* Curve C is reserved and consistent with Curve A currently.

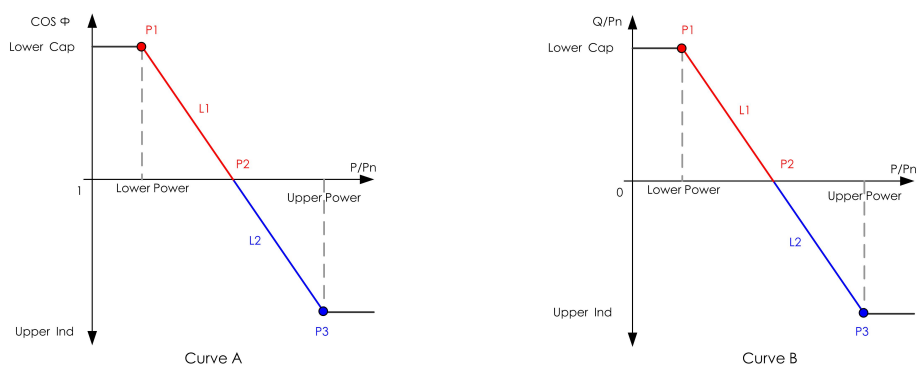

figure 8-19 Q(P) Curve

“Q(U)” Mode

The reactive power output of the inverter will vary in response to the grid voltage.

table 8-10 “Q(U)” Mode Parameter Descriptions:

Parameter	Explanation	Range
Q(U) curve	Select corresponding curve according to local regulations	A, B, C*
Hysteresis Ratio	Voltage hysteresis ratio on the Q(U) mode curve	0 ~ 5%
QU_V1	Grid voltage limit at P1 on the Q(U) mode curve	80% ~ 100%
QU_Q1	Value of Q/Sn at P1 on the Q(U) mode curve	-60% ~ 0
QU_V2	Grid voltage limit at P2 on the Q(U) mode curve	80% ~ 110%
QU_Q2	Value of Q/Sn at P2 on the Q(U) mode curve	-60% ~ 60%
QU_V3	Grid voltage limit at P3 on the Q(U) mode curve	100% ~ 120%
QU_Q3	Value of Q/Sn at P3 on the Q(U) mode curve	-60% ~ 60%
QU_V4	Grid voltage limit at P4 on the Q(U) mode curve	100% ~ 120%
QU_Q4	Value of Q/Sn at P4 on the Q(U) mode curve	0 ~ 60%
QU_EnterPower	Active power for Q(U) function activation	20% ~ 100%
QU_ExitPower	Active power for Q(U) function deactivation	1% ~ 20%
QU_EnableMode	Unconditional activation/deactivation of Q (U) function	Yes / No / Yes, Limited by PF

* Curve C is reserved and consistent with Curve A currently.

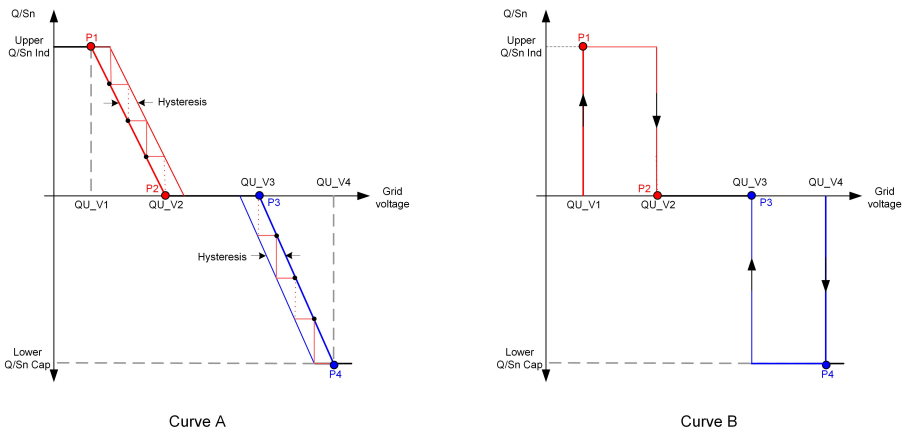

figure 8-20 Q(U) Curve

8.10.7 Battery Discharge Time

Tap **Settings**→**Energy Management Parameter**→**Battery Discharge Time** to enter the corresponding screen, as shown in the following figure.

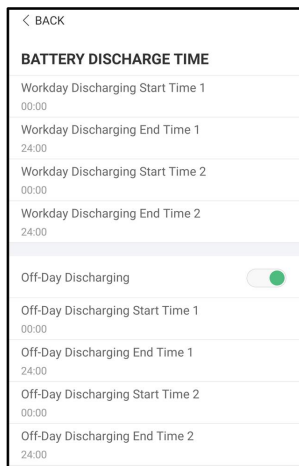

figure 8-21 Battery Discharge Time

8.10.8 Battery Forced Charge Time

Tap **Settings**→**Energy Management Parameter**→**Battery Forced Charge Time** to enter the corresponding screen.

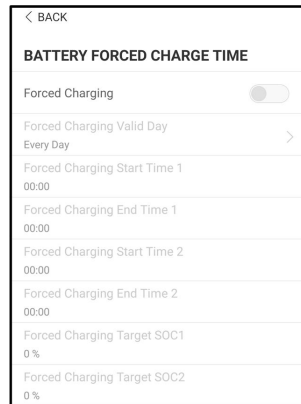

figure 8-22 Battery Forced Charge Time

When there is no PV power, the power imported from the grid charges the energy system during the time period until the target SOC is reached.

It is recommended to set the time period in off-peak tariff time. The time period 1 is in priority to the time period 2 if two periods overlap. The charging energy comes from the excess PV energy in priority and then from the grid. The inverter will take charging power from the grid in the case of PV energy shortage.

8.10.9 Communication Parameters

Tap **Settings**→**Communication Parameters** to enter the screen, as shown in the following figure.

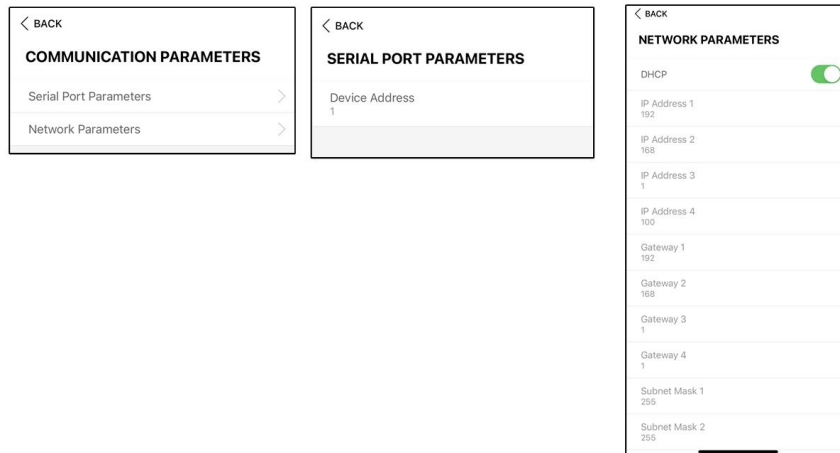



figure 8-23 Communication Parameters

- The device address ranges from 1 to 246.
- The IP address, gateway, subnet mask, preferred DNS server and alternate DNS server can be modified only when the DHCP is set to Off.
- Acquire the IP address, gateway, subnet mask, preferred DNS server and alternate DNS server from the network professional.

8.10.10 Firmware Update

To avoid download failure due to poor on-site network signal, it is recommended to download the firmware package to the mobile device in advance.

- step 1 Enable the "Mobile data" of the mobile device.
- step 2 Open the App, enter the account and password on the login screen. Tap **Login** to enter the home screen.
- step 3 Tap **More**→**Firmware Download** to enter corresponding screen on which you can view the device list.
- step 4 Select the device model before downloading the firmware. Tap the device name in the device list to enter the firmware upgrade package detail interface, and tap  behind the firmware upgrade package to download it.

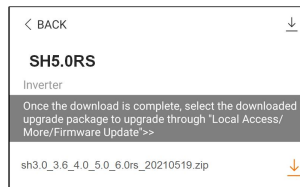

- step 5 Return to the **Firmware Download** screen, tap  in the upper right corner of the screen to view the downloaded firmware upgrade package.
- step 6 Login the App via local access mode. Refer to "8.4 Login".
- step 7 Tap **More** on the App home screen and then tap **Firmware Update**.
- step 8 Tap the upgrade package file, a prompt box will pop up asking you to upgrade the firmware with the file, tap **CONFIRM** to perform the firmware upgrade.

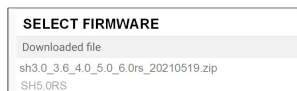

- step 9 Wait for the file to be uploaded. When the upgrade is finished, the interface will inform you of the upgrade completion. Tap **Complete** to end the upgrade.

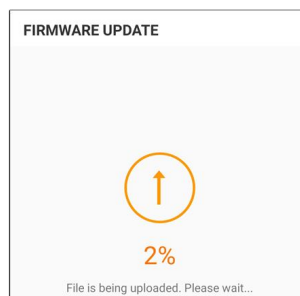

-- End

8.10.11 Grounding Detection



Contact SUNGROW to obtain the advanced account and corresponding password before setting the earth detection parameters.

Unauthorized personnel are not allowed to log in with this account. Otherwise, SUNGROW shall not be held liable for any damages caused.

Tap **More**→**Settings**→**Operation Parameters**→**Grounding Detection** to enter the corresponding screen.

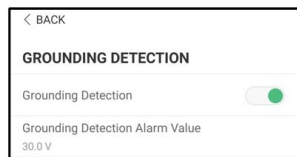

figure 8-24 Grounding Detection

If the grounding detection is enabled, the DO relay will switch on automatically to signal the external alarm if the value exceeds the grounding detection alarm value. The buzzer inside the inverter will beep.

The PV insulation resistance fault (fault sub-code 039) will trigger the DO relay to signal the external alarm.

8.10.12 Frequency Shift Power Control

Tap **More**→**Settings**→**Operation Parameters**→**Other Parameters** to enter the corresponding screen.



Parameter	Default value	Range
Frequency Shift Power Control	OFF	ON / OFF
Frequency Shift Test	OFF	ON / OFF
Set Test Frequency	50.00 Hz	50.00 ~ 55.00 Hz

If PV inverters are connected on the AC side during battery-backup operation, the hybrid inverter must be able to limit their output power. This limitation becomes necessary when, for example, the hybrid inverter's battery is fully charged and the power available from the PV system exceeds the power requirement of the connected loads.

To prevent excess energy from overcharging the battery, the hybrid inverter automatically detects the problem and changes the frequency at the AC output. This frequency adjustment is analyzed by the PV inverter. As soon as the power frequency of the battery-backup grid

increases beyond the value specified in **Set Test Frequency**, the PV inverter limits its output power accordingly.

Before retrofitting the existing PV system to an off-grid port, the **Frequency Shift Power Control** parameter needs to be enabled. It must be ensured that the connected PV inverters limit their power at the AC output via the hybrid inverter due to changes in frequency. The frequency-dependent active power limitation PF must be set in the PV inverter.



When the battery SOC is greater than 85%, the Hybrid inverter will standby before starting when switching off-grid, and does not support seamless switching.

8.10.13 Import Power Limit

Import power is the sum of the battery charging power and the load power of the Backup. Following local regulations, calculate the maximum system tolerable power based on the wire and circuit breaker that required by the selected model, and the value can be set as the **Import Power Limit**. The setup steps are shown below.

Tap **More**→**Settings**→**Operation Parameters**→**Other Parameters** to enter the corresponding screen.

Frequency Shift Power Control	<input type="checkbox"/>
Frequency Shift Test	<input type="checkbox"/>
Set Test Frequency	51.00 Hz
Import Power Limit	13.00 kW

9 System Decommissioning

9.1 Decommissioning the Inverter

9.1.1 Disconnecting the Inverter

For maintenance or other service work, the inverter must be switched off.

Proceed as follows to disconnect the inverter from the AC and DC power sources. Lethal voltages or damage to the inverter will follow if otherwise.

- step 1 Disconnect the external AC circuit breaker and secure it against reconnection.
- step 2 Rotate the DC switch to the "OFF" position for disconnecting all of the PV string inputs.
- step 3 Wait about 10 minutes until the capacitors inside the inverter completely discharge.
- step 4 Ensure that the DC cable is current-free via a current clamp.

-- End

9.1.2 Dismantling the Inverter

CAUTION

Risk of burn injuries and electric shock!

Do not touch any inner live parts until for at least 10 minutes after disconnecting the inverter from the utility grid and the PV input.



Before dismantling the inverter, disconnect both AC and DC connections.

- step 1 Refer to "[6 Electrical Connection](#)" for the inverter disconnection of all cables in reverse steps.
- step 2 Dismantle the inverter referring to "[5 Mechanical Mounting](#)" in reverse steps.
- step 3 If necessary, remove the wall-mounting bracket from the wall.
- step 4 If the inverter will be reinstalled in the future, please refer to "[4.2 Inverter Storage](#)" for a proper conservation.

-- End

9.1.3 Disposal of the Inverter

Users take the responsibility for the disposal of the inverter.

NOTICE

Some parts and devices of the inverter, such as the capacitors, may cause environmental pollution.

Do not dispose of the product together with household waste but in accordance with the disposal regulations for electronic waste applicable at the installation site.

9.2 Decommissioning the Battery

Decommission the battery in the system after the inverter is decommissioned. Proceed as follows to decommission a Li-ion battery.

- step 1 Disconnect the DC circuit breaker between the battery and the inverter.
- step 2 Disconnect the communication cable between the battery and the inverter.
- step 3 Wait for about 1 minute and then use the multimeter to measure the port voltage of the battery.
- step 4 If the battery port voltage is zero, disconnect the power cables from the battery module.

-- End



SUNGROW is not liable for disposal of the battery.

10 Troubleshooting and Maintenance

10.1 Troubleshooting

Once the inverter fails, the fault information can be displayed on the App interface. If the inverter is equipped with an LCD screen, the fault information can be viewed on it.

The fault codes and troubleshooting methods of all Hybrid inverters are detailed in the table below. The device you purchase may only contain some of the fault information, and when the inverter fails, you can check the corresponding information through the fault codes from the mobile App.

Alarm ID	Alarm Name	Corrective Measures
2, 3, 14, 15	Grid overvoltage	<p>Generally, the inverter will be reconnected to the grid after the grid returns to normal. If the fault occurs repeatedly:</p> <ol style="list-style-type: none">1. Measure the actual grid voltage, and contact the local electric power company for solutions if the grid voltage is higher than the set value.2. Check whether the protection parameters are appropriately set via the App or the LCD. Modify the overvoltage protection values with the consent of the local electric power operator.3. If the fault still exists, contact SUNGROW.
4, 5	Grid undervoltage	<p>Generally, the inverter will be reconnected to the grid after the grid returns to normal. If the fault occurs repeatedly:</p> <ol style="list-style-type: none">1. Measure the actual grid voltage, and contact the local electric power company for solutions if the grid voltage is lower than the set value.2. Check whether the protection parameters are appropriately set via the App or the LCD.3. Check whether the AC cable is firmly in place.4. If the fault still exists, contact SUNGROW.

Alarm ID	Alarm Name	Corrective Measures
8	Grid overfrequency	<p>Generally, the inverter will be reconnected to the grid after the grid returns to normal. If the fault occurs repeatedly:</p> <ol style="list-style-type: none"> 1. Measure the actual grid frequency, and contact the local electric power company for solutions if the grid frequency is beyond the set range.
9	Grid underfrequency	<ol style="list-style-type: none"> 2. Check whether the protection parameters are appropriately set via the App or the LCD. 3. If the fault still exists, contact SUNGROW.
10	Grid Power Outage	<p>Generally, the inverter will be reconnected to the grid after the grid returns to normal. If the fault occurs repeatedly:</p> <ol style="list-style-type: none"> 1. Check whether the grid supplies power reliably. 2. Check whether the AC cable is firmly in place. 3. Check whether the AC cable is connected to the correct terminal (whether the live wire and the N wire are correctly in place). 4. Check whether the AC circuit breaker is connected. 5. If the fault still exists, contact SUNGROW.
12	Excess Leakage Current	<ol style="list-style-type: none"> 1. The fault can be caused by poor sunlight or damp environment, and generally the inverter will be reconnected to the grid after the environment is improved. 2. If the environment is normal, check whether the AC and DC cables are well insulated. 3. If the fault still exists, contact SUNGROW.
13	Grid abnormal	<p>Generally, the inverter will be reconnected to the grid after the grid returns to normal. If the fault occurs repeatedly:</p> <ol style="list-style-type: none"> 1. Measure the actual grid, and contact the local electric power company for solutions if the grid parameter exceeds the set range. 2. If the fault still exists, contact SUNGROW.

Alarm ID	Alarm Name	Corrective Measures
17	Grid voltage imbalance	<p>Generally, the inverter will be reconnected to the grid after the grid returns to normal. If the fault occurs repeatedly:</p> <ol style="list-style-type: none"> 1. Measure the actual grid voltage. If grid phase voltages differ greatly, contact the electric power company for solutions. 2. If the voltage difference between phases is within the permissible range of the local power company, modify the grid voltage imbalance parameter through the App or the LCD. 3. If the fault still exists, contact SUNGROW.
28, 29, 208, 448-479	PV reverse connection fault	<ol style="list-style-type: none"> 1. Check whether the corresponding string is of reverse polarity. If so, disconnect the DC switch and adjust the polarity when the string current drops below 0.5 A. 2. If the fault still exists, contact SUNGROW. <p>*The code 28 to code 29 are corresponding to PV1 to PV2 respectively.</p> <p>*The code 448 to code 479 are corresponding to string 1 to string 32 respectively.</p>
532-547, 564-579	PV Reverse Connection Alarm	<ol style="list-style-type: none"> 1. Check whether the corresponding string is of reverse polarity. If so, disconnect the DC switch and adjust the polarity when the string current drops below 0.5 A. 2. If the alarm still exists, contact SUNGROW. <p>*The code 532 to code 547 are corresponding to string 1 to string 16 respectively.</p> <p>*The code 564 to code 579 are corresponding to string 17 to string 32 respectively.</p>

Alarm ID	Alarm Name	Corrective Measures
548-563, 580-595	PV Abnormal Alarm	<p>Check whether the voltage and current of the inverter is abnormal to determine the cause of the alarm.</p> <ol style="list-style-type: none"> 1. Check whether the corresponding module is sheltered. If so, remove the shelter and ensure module cleanness. 2. Check whether the battery board wiring is loose, if so, make it reliably connected. 3. Check if the DC fuse is damaged. If so, replace the fuse. 4. If the alarm still exists, contact SUNGROW. <p>*The code 548 to code 563 are corresponding to string 1 to string 16 respectively.</p> <p>*The code 580 to code 595 are corresponding to string 17 to string 32 respectively.</p>
37	Excessively High Ambient Temperature	<p>Generally, the inverter will resume operation when the internal or module temperature returns to normal.</p> <p>If the fault persists:</p> <ol style="list-style-type: none"> 1. Check whether the ambient temperature of the inverter is too high; 2. Check whether the inverter is in a well-ventilated place; 3. Check whether the inverter is exposed to direct sunlight. Shield it if so; 4. Check whether the fan is running properly. Replace the fan if not; 5. If the fault still exists, contact SUNGROW.
43	Excessively Low Ambient Temperature	<p>Stop and disconnect the inverter. Restart the inverter when the ambient temperature rises within the operation temperature range.</p>

Alarm ID	Alarm Name	Corrective Measures
39	Low System Insulation Resistance	<p>Wait for the inverter to return to normal. If the fault occurs repeatedly:</p> <ol style="list-style-type: none"> 1. Check whether the ISO resistance protection value is excessively high via the app or the LCD, and ensure that it complies with the local regulations. 2. Check the resistance to ground of the string and DC cable. Take corrective measures in case of short circuit or damaged insulation layer. 3. If the cable is normal and the fault occurs on rainy days, check it again when the weather turns fine. 4. If the fault still exists, contact SUNGROW.
106	Grounding cable fault	<ol style="list-style-type: none"> 1. Check whether the AC cable is correctly connected. 2. Check whether the insulation between the ground cable and the live wire is normal. 3. If the fault still exists, contact SUNGROW.
88	Electric Arc Fault	<ol style="list-style-type: none"> 1. Disconnect the DC power supply, and check whether any DC cable is damaged, the connection terminal or fuse is loose or there is a weak contact. If so, replace the damaged cable, fasten the terminal or fuse, and replace the burnt component. 2. After performing step 1, reconnect the DC power supply, and clear the electric arc fault via the App or the LCD, after that the inverter will return to normal. 3. Contact SUNGROW if the fault persists.
84	Reverse Connection Alarm of the Meter/CT	<ol style="list-style-type: none"> 1. Check if the meter is wrongly connected. 2. Check if the input and output wiring of the meter is reversed. 3. If the existing system is enabled, please check if the rated power setting of the existing inverter is correct.
514	Meter Communication Abnormal Alarm	<ol style="list-style-type: none"> 1. Check whether the communication cable and the terminals are abnormal. If so, correct them to ensure reliable connection. 2. Reconnect the communication cable of the meter. 3. If the alarm still exists, contact SUNGROW.
323	Grid Confrontation	<ol style="list-style-type: none"> 1. Check whether the output port is connected to actual grid. Disconnect it from the grid if so. 2. If the fault still exists, contact SUNGROW.

Alarm ID	Alarm Name	Corrective Measures
75	Inverter Parallel Communication Alarm	<ol style="list-style-type: none"> 1. Check whether the communication cable and the terminals are abnormal. If so, correct them to ensure reliable connection. 2. Reconnect the communication cable of the meter. 3. If the alarm still exists, contact SUNGROW.
714	BMS communication fault	<ol style="list-style-type: none"> 1. Check whether the communication cable and the terminals are abnormal. If so, correct them to ensure reliable connection. 2. Reconnect the communication cable of the meter. 3. If the fault still exists, contact SUNGROW.
716	Abnormal battery connection	<ol style="list-style-type: none"> 1. Check and correct polarity of cable connection between the battery and the inverter. 2. If the fault still exists, contact SUNGROW.
932–935, 937, 939, 964	Battery alarm	<p>Generally, the battery can automatically recover. In case the alarm persist for a long time:</p> <ol style="list-style-type: none"> 1. If the alarm is caused by ambient temperature, such as over temperature alarm or low temperature alarm, take measures to change the ambient temperature, such as improving heat dissipation conditions. 2. If the fault persists, contact battery manufacturer.
703, 707, 708, 711, 712, 715, 717, 732–737, 739, 832–837, 839, 844, 864, 866–868, 870	Battery fault	<ol style="list-style-type: none"> 1. In case of abnormal battery voltage, check whether the battery power cable connection is abnormal (reverse connection, loose, etc.). If so, correct it to ensure reliable connection. 2. Check whether the battery real-time voltage is abnormal if the battery power cable is correctly connected. If so, contact the battery manufacturer. If not, contact SUNGROW. 3. In case of abnormal battery temperature, take measures to change the ambient temperature, such as improving heat dissipation conditions. 4. If the fault persists, contact battery manufacturer.

Alarm ID	Alarm Name	Corrective Measures
7, 11, 16, 19–25, 30– 34, 36, 38, 40–42, 44– 50, 52–58, 60–68, 85, 87, 92, 93, 100–105, 107–114, 116–124, 200–211, 248–255, 300–322, 324–326, 401–412, 600–603, 605, 608, 612, 616, 620, 622– 624, 800, 802, 804, 807, 1096– 1122	System Fault	<ol style="list-style-type: none"> 1. Wait for the inverter to return to normal. 2. Disconnect the AC and DC switches, and reconnect the AC and DC switches 15 minutes later to restart the inverter. 3. If the fault still exists, contact SUNGROW.
59, 70–72, 74, 76, 82, 83, 89, 77– 81, 216–218, 220–231, 432–434, 500–513, 515–518, 900, 901, 910, 911	System Alarm	<ol style="list-style-type: none"> 1. The inverter can continue running. 2. Check whether the related wiring and terminal are abnormal, check whether there are any foreign materials or other environmental abnormalities, and take corresponding corrective measures when necessary. 3. If the alarm persists, please contact SUNGROW.

Alarm ID	Alarm Name	Corrective Measures
264-283	MPPT Reverse Connection	<ol style="list-style-type: none"> 1. Check whether the corresponding string is of reverse polarity. If so, disconnect the DC switch and adjust the polarity when the string current drops below 0.5 A. 2. If the fault still exists, contact SUNGROW. <p>*The code 264 to code 279 are corresponding to string 1 to string 20 respectively.</p>
332-363	Boost Capacitor Overvoltage Alarm	<ol style="list-style-type: none"> 1. The inverter can continue running. 2. Check whether the related wiring and terminals are abnormal, check whether there are any foreign materials or other environmental abnormalities, and take corresponding corrective measures when necessary. 3. If the alarm persists, please contact SUNGROW.
364-395	Boost Capacitor Overvoltage Fault	<ol style="list-style-type: none"> 1. Disconnect the AC and DC switches, and reconnect the AC and DC switches 15 minutes later to restart the inverter. 2. If the fault still exists, contact SUNGROW.
1548-1579	String Current Reflux	<ol style="list-style-type: none"> 1. Check whether the number of PV modules of the corresponding string is less than other strings. If so, disconnect the DC switch and adjust the PV module configuration when the string current drops below 0.5 A. 2. Check whether the PV module is shaded. 3. Disconnect the DC switch to check whether the open circuit voltage is normal when the string current drops below 0.5 A. If so, check the wiring and configuration of the PV module. 4. Check whether the orientation of the PV module is abnormal.



If the communication cable between the hybrid inverter and the battery is not connected correctly during the first installation, the battery may not work properly or the parameter information of the battery may not be displayed on the inverter. Please check the communication cable to ensure a correct connection.

10.2 Maintenance

10.2.1 Maintenance Notices

The DC switch can be secured with a lock in the OFF position or a certain angle beyond the OFF position.

DANGER

Risk of inverter damage or personal injury due to incorrect service!

- Always keep in mind that the inverter is powered by dual sources: PV strings and utility grid.

Before any service work, observe the following procedure.

- Disconnect the AC circuit breaker and then set the DC switch of the inverter to OFF;
- The DC switch can be secured with a lock in the OFF position or a certain angle beyond the OFF position.
- Wait at least 10 minutes for inner capacitors to discharge completely;
- Verify that there is no voltage or current before pulling any connector.

CAUTION

Keep non-related persons away!

A temporary warning sign or barrier must be posted to keep non-related persons away while performing electrical connection and service work.

NOTICE

- Restart the inverter only after removing the fault that impairs safety performance.
- As the inverter contains no component parts that can be maintained, never arbitrarily replace any internal components.
- For any maintenance need, please contact SUNGROW. Otherwise, SUNGROW shall not be held liable for any damage caused.



Service of the device in accordance with the manual should never be undertaken in the absence of proper tools, test equipments or the latest revision of the manual which has been clearly and thoroughly understood.

10.2.2 Routine Maintenance

Item	Method	Period
System clean	Check the temperature and dust of the inverter. Clean the inverter enclosure if necessary.	Six months to a year (depending on the dust contents in air)
Electrical connection	Check whether all cable are firmly connected in place. Check whether there is damage to the cables, especially the surface in contact with metal.	6 months after commissioning and then once or twice a year.
General status of the system	<ul style="list-style-type: none"> • Visual check for any damage or deformation of the inverter. • Check any abnormal noise during the operation. • Check each operation parameter. • Be sure that nothing covers the heat sink of the inverter. 	Every 6 months

11 Appendix

11.1 Technical Data

Parameter	SH3.0RS	SH3.6RS
Input (DC)		
Recommended max. PV input power	10000 Wp	10700 Wp
Max. PV input voltage	600 V	
Min. operating PV voltage / Start-up input voltage	40 V / 50 V	
Rated PV input voltage	360 V	
MPP voltage range	40 V – 560 V	
No. of independent MPP inputs	2	
Default No. of PV strings per MPPT	1	
Max. PV input current	32 A (16 A / 16 A)	
Max. DC short-circuit current	40 A (20 A / 20 A)	
Max. inverter backfeed current to strings	0 A	
Input / Output (AC)		
Max. AC input power from grid	10000 VA	10700 VA
Rated AC output power	3000 W	3680 W
Max. AC output power	3000 VA	3680 VA
Rated AC output current (at 230V)	13.1 A	16.0 A
Max. AC output current	13.7 A	16.0 A
Rated AC voltage	220 V / 230 V / 240 V	
AC voltage range	154 V – 276 V	
Rated grid frequency	50 Hz / 60 Hz	
Grid frequency range	45 Hz – 55 Hz / 55 Hz – 65 Hz	
Harmonic (THD)	< 3 % (of rated power)	
Power factor at rated power / Adjustable power factor	> 0.99 at default value at rated power (adj. 0.8 overexcited / leading to 0.8 underexcited / lagging)	

Parameter	SH3.0RS	SH3.6RS
Feed-in phases / connection phases	1 / 1	
Efficiency		
Max. efficiency	97.4%	97.5%
European efficiency	97.0%	97.1%
Protection		
Grid monitoring	Yes	
DC reverse polarity protection	Yes	
AC short circuit protection	Yes	
Leakage current protection	Yes	
Surge Protection	DC Type II / AC Type II	
DC switch (solar)	Yes	
DC fuse (battery)	Yes	
PID recovery function	Yes	
Battery input reverse polarity protection	Yes	
Battery Data		
Battery type	Li-ion battery	
Battery voltage	80 V – 460 V	
Max. charge / discharge current	30 A / 30 A	
Max. charge / discharge power	6600 W	
General Data		
Dimensions (W x H x D)	490 mm x 340 mm x 170 mm	
Weight	18.5 kg	
Mounting method	Wall-mounting bracket	
Topology (Solar / Battery)	Transformerless / Transformerless	
Degree of protection	IP65	
Operating ambient temperature range	-25°C to +60°C	
Allowable relative humidity range	0 – 100 %	
Cooling method	Natural convection	
Max. operating altitude	4000 m	
Display	LED digital display, LED indicator	
Communication	RS485 / Ethernet / WLAN / CAN	
DI / DO	DI * 4 / DO * 1 / DRM	
DC connection type	MC4 (PV) / Sunclix (Battery)	
AC connection type	Plug and play	

Parameter	SH3.0RS	SH3.6RS	
Backup Data (on grid mode)			
Rated output power for backup load	6000 W		
Rated output current for backup load	27.3 A		
Backup Data (off-grid mode)			
Rated voltage	220 V / 230 V / 240 V (±2 %)		
Frequency range	50 Hz / 60 Hz (±0.2 %)		
Total output THDv for linear load	< 2 %		
Switch time to emergency mode	< 10 ms		
Rated output power	3000 W / 3000 VA	3680 W / 3680 VA	
Peak output power	8400 VA , 10s		
Parameter	SH4.0RS	SH5.0RS	SH6.0RS
Input (DC)			
Recommended max. PV input power	11000 Wp	12000 Wp	13000 Wp
Max. PV input voltage	600 V		
Min. operating PV voltage / Start-up input voltage	40 V / 50 V		
Rated PV input voltage	360 V		
MPP voltage range	40 V – 560 V		
No. of independent MPP inputs	2		
Default No. of PV strings per MPPT	1		
Max. PV input current	32 A (16 A / 16 A)		
Max. DC short-circuit current	40 A (20 A / 20 A)		
Max. inverter backfeed current to strings	0 A		
Input / Output (AC)			
Max. AC input power from grid	11000 VA	12000 VA	13000 VA
Rated AC output power	4000 W	4999 W for "AU", 5000 W for others	6000 W

Parameter	SH4.0RS	SH5.0RS	SH6.0RS
Max. AC output power	4000 VA	4999 VA for "AU", 5000 VA for others	6000 VA
Rated AC output current (at 230V)	17.4 A	21.7 A for "AU", 21.8 A for others	26.1 A
Max. AC output current	18.2 A	21.7 A for "AU", 22.8 A for others	27.3 A
Rated AC voltage	220 V / 230 V / 240 V		
AC voltage range	154 V – 276 V		
Rated grid frequency	50 Hz / 60 Hz		
Grid frequency range	45 Hz – 55 Hz / 55 Hz – 65 Hz		
Harmonic (THD)	< 3 % (of rated power)		
Power factor at rated power / Adjustable power factor	> 0.99 at default value at rated power (adj. 0.8 overexcited / leading–0.8 underexcited / lagging)		
Feed-in phases / connec- tion phases	1 / 1		
Efficiency			
Max. efficiency	97.6 %	97.7 %	97.7 %
European efficiency	97.2 %	97.3 %	97.3 %
Protection			
Grid monitoring	Yes		
DC reverse polarity protection	Yes		
AC short circuit protection	Yes		
Leakage current protection	Yes		
Surge protection	DC Type II / AC Type II		
DC switch (solar)	Yes		
DC fuse (battery)	Yes		
PID recovery	Yes		
Battery input reverse polar- ity protection	Yes		
Battery Data			
Battery type	Li-ion battery		
Battery voltage	80 V – 460 V		
Max. charge / discharge current	30 A / 30 A		

Parameter	SH4.0RS	SH5.0RS	SH6.0RS
Max. charge / discharge power		6600 W	
General Data			
Dimensions (W x H x D)	490 mm x 340 mm x 170 mm		
Weight	18.5 kg		
Mounting method	Wall-mounting bracket		
Topology (solar / battery)	Transformerless / Transformerless		
Degree of protection	IP65		
Operating ambient temperature range	-25°C to +60°C		
Allowable relative humidity range	0 – 100 %		
Cooling method	Natural convection		
Max. operating altitude	4000 m		
Display	LED digital display, LED indicator		
Communication	RS485 / Ethernet / WLAN / CAN		
DI / DO	DI * 4 / DO * 1 / DRM		
DC connection type	MC4 (PV) / Sunclix (Battery)		
AC connection type	Plug and play		
Backup Data (on grid mode)			
Rated output power for backup load	6000 W		
Rated output current for backup load	27.3 A		
Backup Data (off-grid mode)			
Rated voltage	220 V / 230 V / 240 V (±2 %)		
Frequency range	50 Hz / 60 Hz (±0.2 %)		
Total output THDv for linear load	< 2 %		
Switch time to emergency mode	< 10ms		
Rated output power	4000 W / 4000 VA	5000 W / 5000 VA	6000 W / 6000 VA
Peak output power	8400VA , 10s		

11.2 Quality Assurance

When product faults occur during the warranty period, SUNGROW will provide free service or replace the product with a new one.

Evidence

During the warranty period, the customer shall provide the product purchase invoice and date. In addition, the trademark on the product shall be undamaged and legible. Otherwise, SUNGROW has the right to refuse to honor the quality guarantee.

Conditions

- After replacement, unqualified products shall be processed by SUNGROW.
- The customer shall give SUNGROW a reasonable period to repair the faulty device.

Exclusion of Liability

In the following circumstances, SUNGROW has the right to refuse to honor the quality guarantee:

- The free warranty period for the whole machine/components has expired.
- The device is damaged during transport.
- The device is incorrectly installed, refitted, or used.
- The device operates in harsh conditions beyond those described in this manual.
- The fault or damage is caused by installation, repairs, modification, or disassembly performed by a service provider or personnel not from SUNGROW.
- The fault or damage is caused by the use of non-standard or non-SUNGROW components or software.
- The installation and use range are beyond stipulations of relevant international standards.
- The damage is caused by unexpected natural factors.

For faulty products in any of above cases, if the customer requests maintenance, paid maintenance service may be provided based on the judgment of SUNGROW.

11.3 Contact Information

Should you have any question about this product, please contact us.

We need the following information to provide you the best assistance:

- Model of the device
- Serial number of the device
- Fault code/name
- Brief description of the problem

<p>China (HQ) Sungrow Power Supply Co., Ltd Hefei +86 551 65327834 service@sungrowpower.com</p>	<p>Australia Sungrow Australia Group Pty. Ltd. Sydney +61 2 9922 1522 service@sungrowpower.com.au</p>
<p>Brazil Sungrow Do Brasil Sao Paulo +55 0800 677 6000 latam.service@sungrowamericas.com</p>	<p>France Sungrow France Lyon +33420102107 service@sungrow-emea.com</p>
<p>Germany, Austria, Switzerland Sungrow Deutschland GmbH Munich +49 (0)89 1307 2620 service@sungrow-emea.com</p>	<p>Greece Service Partner – Survey Digital +30 2391052757 service@sungrow-emea.com</p>
<p>India Sungrow (India) Private Limited Gurgaon +91 080 41201350 service@in.sungrowpower.com</p>	<p>Italy Sungrow Italy Verona +39 0800 974739 (Residential) +39 045 4752117 (Others) service@sungrow-emea.com</p>
<p>Japan Sungrow Japan K.K. Tokyo + 81 3 6262 9917 service@jp.sungrowpower.com</p>	<p>Korea Sungrow Power Korea Limited Seoul +82 70 7719 1889 service@kr.sungrowpower.com</p>
<p>Malaysia Sungrow SEA Selangor Darul Ehsan +60 19 897 3360 service@my.sungrowpower.com</p>	<p>Philippines Sungrow Power Supply Co., Ltd Mandaluyong City +63 9173022769 service@ph.sungrowpower.com</p>
<p>Thailand Sungrow Thailand Co., Ltd. Bangkok +66 891246053 service@th.sungrowpower.com</p>	<p>Spain Sungrow Ibérica S.A.U. Mutilva +34 948 05 22 04 service@sungrow-emea.com</p>

Romania

Service Partner - Elerex
service@sungrow-emea.com

Turkey

Sungrow Deutschland GmbH Turkey
 Istanbul
 +90 216 663 61 80
service@sungrow-emea.com

UK

Sungrow Power UK Ltd.
 Milton Keynes
 +44 (0) 01908 414127
service@sungrow-emea.com

U.S.A, Mexico

Sungrow USA Corporation
 Phoenix
 +1 833 747 6937
techsupport@sungrow-na.com

Vietnam

Sungrow Vietnam
 Hanoi
 +84 918 402 140
service@vn.sungrowpower.com

Belgium, Netherlands and Luxembourg (Benelus)

+31 853 018 234 (only for Netherlands)
service@sungrow-emea.com

Poland

+48 221530484
service@sungrow-emea.com

-