



Publisher:  
Solare Datensysteme GmbH  
Fuhrmannstr. 9  
72351 Geislingen-Binsdorf  
Germany

International support  
Tel.:+49 7428 9418 -640  
Fax:+49 7428 9418 -280

e-mail: [support@solar-log.com](mailto:support@solar-log.com)

Italy  
Technical support: +39 0471 631032  
e-mail: [italy-support@solar-log.com](mailto:italy-support@solar-log.com)

France  
Technical support: +33 97 7909708  
e-mail: [france-support@solar-log.com](mailto:france-support@solar-log.com)

Switzerland  
Technical support: +41 565 355346  
e-mail: [switzerland-fl-support@solar-log.com](mailto:switzerland-fl-support@solar-log.com)

United States  
Technical support: +1 203 702 7189  
e-mail: [usa-support@solar-log.com](mailto:usa-support@solar-log.com)

# Table of Contents

1	Introduction.....	7
2	Safety information .....	8
2.1	Hazard Classes .....	8
3	Electric current.....	9
4	Package Contents and Installation .....	10
5	Solar-Log 50 Connections.....	11
5.1	Top Connections Solar-Log 50 .....	11
5.2	Bottom Connections Solar-Log 50 .....	12
6	Connector Assignments and Wiring.....	13
6.1	Notes on wiring the connections.....	13
6.2	2 x RS485 (A/B) or 1 x RS422.....	14
7	Connecting the inverters.....	15
7.1	Switch off the inverters and the Solar-Log™. .....	16
8	Connecting accessories .....	17
8.1	External power meter.....	17
8.1.1	External power meters/accumulating meters.....	18
9	Other connections .....	19
9.1	USB.....	19

<b>10</b>	<b>Installation.....</b>	<b>20</b>
10.1	Connect the Solar-Log™ to a network / PC.....	20
10.2	Initial set up of the Solar-Log 50.....	21
<b>11</b>	<b>Go to the Main Menu.....</b>	<b>22</b>
11.1	Operating the Main Menu of the Solar-Log™.....	25
11.1.1	Control elements.....	26
11.2	Explanations of the names in the main menu.....	27
11.2.1	Header bar.....	27
11.2.2	Left-side navigation menu.....	27
11.2.3	Configuration Page.....	27
11.2.4	Login Section Menu.....	28
11.2.5	Hide arrow.....	30
11.2.6	New Firmware.....	30
11.3	Setting up of the Solar-Log™ with the configuration assistant.....	32
11.3.1	Solar-Log 50 Manual Configuration.....	37
<b>12</b>	<b>Main menu.....</b>	<b>38</b>
12.1	Virtual LCD Display.....	38
<b>13</b>	<b>Configuration Menu.....</b>	<b>39</b>
13.1	Configuring network settings.....	39
13.1.1	Ethernet.....	40
13.1.2	Proxy.....	42
13.2	Internet Configuration.....	43
13.2.1	Portal.....	43
13.3	Configuring connected devices.....	45
13.3.1	Device definition.....	46
13.3.2	Device Detection.....	48
13.3.3	Configuring devices.....	49
13.3.4	Configuring inverters.....	49
13.3.5	Generation Information on PAC Correction Factor.....	50
13.3.6	Configuring power meters.....	51
13.3.7	Configure the battery.....	52
13.3.8	Module Fields, Power Output and Descriptions.....	52
13.4	Feed-in management (with an active license).....	54
13.4.1	Plant parameters.....	54
13.4.2	Active power.....	54
13.4.3	Active power deactivated.....	55
13.4.4	70% fixed reduction.....	55
13.4.5	70% Fixed reduction with the calculation of self-consumption.....	56
13.4.6	Adjustable reduction.....	56
13.4.7	Adjustable Reduction with the Calculation of Self-Consumption.....	57
13.4.8	Fixed reduction in watts.....	57
13.4.9	Fixed reduction in watts with the calculation of self-consumption.....	57

13.4.10	Percentage of consumption for an adjustable reduction.....	58
13.5	Editing Data .....	58
13.5.1	System backup.....	58
13.5.2	Backup .....	61
13.5.3	Reset .....	63
13.6	System Configuration.....	64
13.6.1	Access control.....	64
13.6.2	HTTPS.....	65
13.6.3	Language/Country/Time .....	66
13.6.4	Licenses .....	68
13.6.5	Firmware .....	69
<b>14</b>	<b>Diagnostics Menu.....</b>	<b>72</b>
14.1	Accessing Support .....	72
14.2	Starting Feed-in management (with an active license).....	73
14.2.1	Explanation of the Values in the Power Reduction Section.....	74
14.2.2	Explanation of the Symbols in the Feed-in power (% DC) column:.....	76
<b>15</b>	<b>Yield Data Menu.....</b>	<b>77</b>
15.1	Current values .....	77
15.1.1	Table .....	78
<b>16</b>	<b>Symbols on the virtual LCD display .....</b>	<b>79</b>
16.1	Meaning of the symbols on the virtual LCD display .....	79
16.2	Fault messages .....	80
16.3	Normal operation .....	80
<b>17</b>	<b>Notifications via LED .....</b>	<b>81</b>
17.1	LED status indications.....	81
<b>18</b>	<b>Faults.....</b>	<b>82</b>
18.1	Restarting and resetting.....	82
18.1.1	Reset buttons .....	82
18.2	Fault messages .....	83
18.2.1	Fault messages time .....	83
18.2.2	Fault messages Internet .....	83
18.2.3	Portal Transfer Fault messages.....	84
<b>19</b>	<b>Cleaning and care.....</b>	<b>85</b>

19.1	Cleaning tips .....	85
19.2	Care tips.....	85
20	Disposal.....	86
21	Appendix .....	87
21.1	Internet ports.....	87
22	Dimensions .....	88
23	List of Figures .....	89

# 1 Introduction

---

This manual is intended for use by solar energy technicians and professional electricians, as well as Solar-Log 50 users. It should be noted that the installation and commissioning of the individual components is only to be performed by properly trained specialists. Refer to Chapter 4 "Safety information" for more information.

The wiring for the devices is described in detail in the [Component Installation Manual](#).

The Solar-Log™ must only be used by persons who have fully read and understood the manual before installing, operating and/or servicing the device.

Our product documentation is being constantly updated and expanded.

The current versions of the documents can be downloaded from our website:

<https://www.solar-log.com/de/support/downloads>.

The descriptions in this manual refer to firmware version 4.1.1.

## 2 Safety information

---

In order to protect people, the device itself, and other equipment, please pay attention to the following before handling the product:

- the content of this manual,
- the safety information,
- the warning signs and type plates attached to the product.

### Note:

All the actions described in this manual for wiring and working on the individual components must be carried out only by specially trained electricians. All repairs should only be carried out by similarly trained personnel, or by the manufacturers themselves.

Solare-Datensysteme GmbH is not liable for any personal injuries, property damages and system malfunctions and their consequences which result from not adhering to the product documentation.

### 2.1 Hazard Classes

The safety instructions in this document are represented with standard signs and symbols. Two classes of risk are identified, depending on their probability of occurrence and the seriousness of their consequences.

#### Danger



Indicates an imminently hazardous situation to life  
Non-compliance with this warning can lead to severe and irreversible injuries or death

#### Caution



Indicates an imminently hazardous situation to people, or a risk of material damage  
Non-compliance with this warning can lead to irreversible injuries or to material damage.



## 3 Electric current

---

### Danger



Risk of death by electric shock if inverters are opened.  
 Never open the inverter housing when the inverter is connected to power.  
 Refer to Switching inverters off.  
 Always read the installation and safety instructions given in the manual for the corresponding inverter.

### Danger



Danger of death if there is condensation in the power supply unit when started!  
 Condensation can occur if the power supply unit is moved directly from a cold environment to a warm environment.  
 Wait until the temperatures have equalized before doing this.

### Caution



Damage to the electrical components in inverters and on interface cards due to electrostatic discharge.  
 Avoid contact with component connections and plug contacts.  
 Before picking up the component, ground yourself by holding the protective conductor (PE) or the unpainted part of the inverter housing.

### Caution



Damage to the electrical components of the Solar-Log™ due to the wiring of the Solar-Log™!  
 Disconnect the Solar-Log™ from the power supply.

### Caution



Risk of electric shock.  
 Do not use the unit if the housing of the external power supply unit is damaged. A damaged power supply unit must be replaced by one of the same type in order to avoid danger.

### Caution



The Solar-Log™ may only be used indoors or enclosed spaces.  
 The device has the protection class IP20.

## 4 Package Contents and Installation

---

Check the package contents before proceeding to assembly and installation.

Report any damage or missing parts to the forwarding agent and dealer immediately.

The device is produced according to protection class IP20 and is intended only for installation in interior areas that are dry and dust-free.

It can be mounted on the wall (see illustration below) or on a top-hat rail (refer to the Solar-Log™ dimensions in chapter 22). Power can come from a DIN rail power supply or a 24V power supply with an adapter.

### Note



Please note that a power supply is not included in the package contents.

### Wall mounting

For wall mounting, extend the snap-fit tabs on the bottom of the device and attach it to the wall with a suitable device and accessories.



Fig.: Solar-Log 50 without extended snap-fit tabs



Fig.: Solar-Log 50 with extended snap-fit tabs

## 5 Solar-Log 50 Connections

### 5.1 Top Connections Solar-Log 50

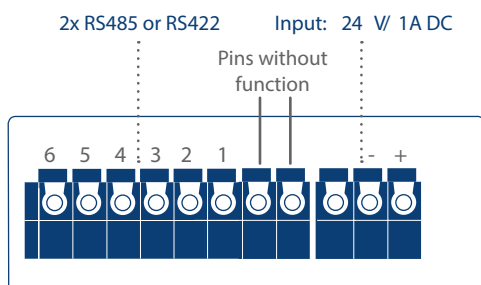

Fig.: Top Connections – Solar-Log 50

#### Solar-Log 50 Top connections

2 x RS485 or RS422	Connection for inverters and additional accessories
-----------------------	--

Input: 24 V/1A DC	Connection pins for the power supply
----------------------	---

#### Technical Data

Nominal voltage	24V = +- 5% or 24VDC +- 5%
-----------------	----------------------------

Maximum cable cross-section	SOLID WIRE: 30-16 AWG / 0.05-1.31 mm <sup>2</sup> (Solid wire)
	STRANDED WIRE: 30-16 AWG / 0.05-1.31 mm <sup>2</sup> (Litz wire)

Power consumption	< 0.5W
-------------------	--------

## 5.2 Bottom Connections Solar-Log 50

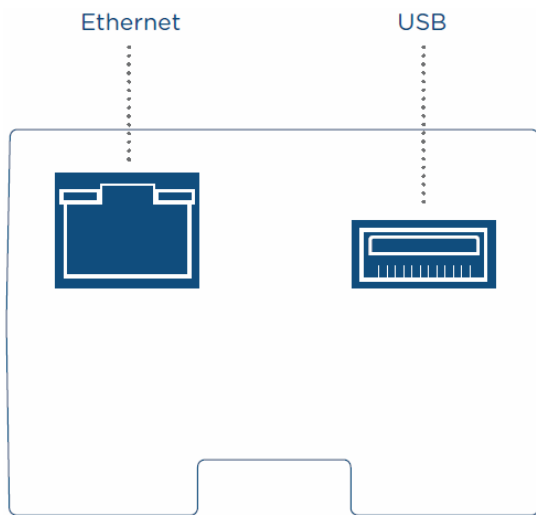

Fig.: Bottom connections Solar-Log 50

---

### Bottom of the Solar-Log 50

---

USB	USB connection. Suitable for USB sticks. Not suitable for a connection to a PC / laptop.
Network	Ethernet network interface, 10/100 Mbit

---

#### Note



This USB connection can only be used for USB sticks and not for a direct PC or laptop connection.

## 6 Connector Assignments and Wiring

---

The following connecting cables, which may be needed for various purposes, are not included in the package content.

- To connect a router, you need a network cable with the appropriate length. If you want to connect the Solar-Log™ directly to your PC or laptop, you need to use a crossover cable.
- Cable to connect the Solar-Log™ to an inverter.
- Sets of prefabricated cables are available as accessories suitable for the inverter concerned. The length of these cable sets is 3 m.
- If you want to connect several inverters to Solar-Log™, you need suitable cables and connectors to connect the inverters to each other.
- When wiring with CAT cables, the twisted pair of wires should be used.

### 6.1 Notes on wiring the connections

The wiring of the inverters and accessories needs to be carried out with the greatest care and attention. The most frequent source of errors when installing the Solar-Log™ is faulty wiring.

For this reason, we recommend:

- Wiring with high quality cables  
For example: LIYCY  $\geq 0.14\text{mm}^2$  or Cat 5/7 SFTP
- Refer to the manufacturer's specifications in regard to UV resistance and mounting type when wiring in outside areas.
- A larger cable diameter is recommended for longer distances.
- Use ferrules with flexible wires
- Twist the corresponding wire pairs and shielding
- Wire from left-to-right.
- Wire from light to dark.

## 6.2 2 x RS485 (A/B) or 1 x RS422

Use the provided terminal blocks when connecting inverters or accessories to the RS485 or RS422 interface.

### RS485 Connection Block Pin Assignment

	RS485-A	RS485-B
PIN	Assignment	Assignment
1	Data+	-
2	12 V	-
3	Ground / GND	-
4	Data-	-
5	-	Data+
6	-	Data-

### RS422 Connection Block Pin Assignment

RS422	
PIN	Assignment
1	T/RX+
2	12V
3	Ground / GND
4	T/RX-
5	R/TX+
6	R/TX-

#### Note



If inverters that use the RS422 connection are connected to this interface (e.g. Fronius, AEG, Riello), then it is not possible to connect accessories such as sensors or meters to this bus.

## 7 Connecting the inverters

---

As each inverter manufacturer uses different wiring connections and connectors, the corresponding data cables must be adapted correctly.

- See Chapter „Belegung und Verkabelung der Anschlüsse“ for terminal block connector wiring diagrams for the connection to the Solar-Log™
- Please refer to the Component Connection Manual when connecting inverters supported by the Solar-Log™. (Download from <https://www.solar-log.com/en/support/downloads/manuals>)

### Note



Solare Datensysteme GmbH supplies suitable connection cables for most inverter manufacturers.

Always read the manufacturer-specific instructions for connecting the data cable. You will find these instructions in the manufacturer's documentation.

However, when assigning the inverter wiring on the Solar-Log™, follow the instructions in this manual, otherwise the inverters will not be detected by Solar-Log™.

### Danger



Risk of death by electric shock if inverters are opened.

Never open the inverter housing when the inverter is connected to power.

See the chapter "Switching inverters off."

Always read the installation and safety instructions given in the manual for the corresponding inverter.

## 7.1 Switch off the inverters and the Solar-Log™.

### Switching inverters off

Before making a cable connection between the Solar-Log™ and the connections inside the inverter and before installing an interface card in the inverter, always turn off all of the inverters first.

To do this, read the manufacturer's documentation for the inverter, and proceed as follows:

- Disconnect the AC side.
- Disconnect the DC side.
- Wait at least 5 minutes until the condensers in the inverters have discharged.

### Turn the Solar-Log™ off.

- Hold down reset button for 10 seconds and then release it as soon as the components LED turns  **Orange**. The Solar-Log™ will shut down and can be disconnected from the power supply (see chapter 18.1.1 "Reset Button" for more information).



## 8 Connecting accessories

---

### 8.1 External power meter

External power meters can be connected to the Solar-Log™ via the RS-485 bus.

The energy recorded by these meters can be used for numerous applications:

- Generator Mode:  
This mode is used, for example, for inverters that are not directly supported by Solar-Log™.
- Total yield meter:  
This mode is used to record the energy production of several inverters.
- Consumption meter:  
This mode is used to measure power consumption and to make it possible to display this data.

#### Note



We recommend using the meters that we have tested and offer.  
We cannot guarantee the functionality of other products.

#### Note



Refer to the Meter Connection Manual for all of the supported meters and their wiring diagram. Download it from our website:  
<https://www.solar-log.com/en/support/downloads/manuals>

## 8.1.1 External power meters/accumulating meters

With multiple phase meters, a basic distinction is made between phase-exact and accumulating meters.

Accumulating meters provide the total values from all three phases. The meter calculates the total output (also to and from the grid) of the individual phases and provides this total as a single value.

In the example:

Phase 1 supplies 3 kW via an inverter (single phase).

Phase 2 draws 2 kW (energy)

Phase 3 draws 1 kW (energy)

With an accumulating meter, this results in a total of 0 kW.

Examples of accumulating meters are the Janitza UMG 104/UMG 604 and the Solar-Log™ Pro380-Mod.

## 9 Other connections

---

### 9.1 USB

The Solar-Log 50 comes with an USB connection. This USB connection can only be used for USB sticks and not, for example, for a direct PC or laptop connection.

#### Note



When a USB stick is connected, the Solar-Log™ automatically saves a backup in the backup folder. A maximum of 10 backup files are saved in the directory. Older backup files are automatically deleted.

The backup is saved on the USB stick in the directory /Backup with the following file names:

- solarlog\_backup\_YYMMDD.dat:  
YYMMDD = year, month and day - each two digits, e.g.  
180502 is then 02 May 2018

# 10 Installation

---

The Solar-Log 50 has an integrated web server, which contains all the software necessary for operation and configuration.

No additional software needs to be installed on the PC to access the Solar-Log™.

A common web browser with JavaScript enabled is required.

We recommend using the current version of Mozilla's Firefox, Google's Chrome or Microsoft's Edge.

To run the web browser, a network connection is required between the PC or laptop and Solar-Log™, and Solar-Log™ must be up and running.

It is required to have DHCP enabled on the router.

## 10.1 Connect the Solar-Log™ to a network / PC.

The Solar-Log™ is equipped with a standard Ethernet RJ45 socket, which can be connected through any commercially available network cable. Speeds of 10 Mbit and 100 Mbit are supported.

In general, any PC networking technology can be used for connecting the Solar-Log™. The following technologies are available:

- Connection through an Internet router:  
Ethernet RJ45 network cable.
- Direct cable connection from the PC to the Solar-Log™:  
Ethernet RJ45 network patch cable.

If the Solar-Log™ is operated via a router, ensure that the necessary ports have been activated (see Chapter „Internet-Ports“).

### Note



The Solar-Log 50 has DHCP activated by default to be able to establish a connection when connected to a router with DHCP enabled.

## 10.2 Initial set up of the Solar-Log 50

The complete configuration of the Solar-Log 50 can be done via the PC/laptop or via a tablet or smart-phone.

### Requirements

- All cables and accessories (if any) have been connected to the Solar-Log™.
- The Solar-Log<sup>50</sup> is connected to an Internet router.
- The DHCP service is enabled on the Internet router.

or

- The DHCP service is enabled when connecting directly to the Solar-Log™ with a PC.  
(We recommend using a patch cable.)

# 11 Go to the Main Menu.

The various options to open the main menu of the Solar-Log™ are listed below:

## Device URL

- Start the web browser.
- Enter `http://solar-log` in the address bar and press the ENTER key.
- The main menu of the Solar-Log™ is displayed.

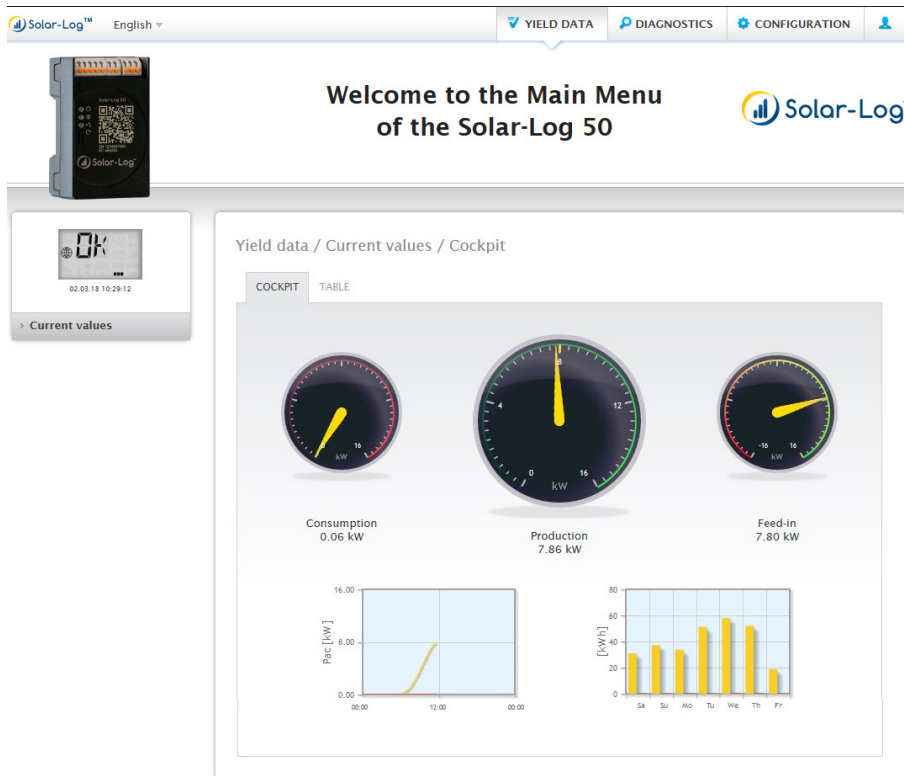

Fig.: Main menu of the Solar-Log 50

Alternatively, the Solar-Log™ can also be accessed as follows:

## IP address from an automatic IP range:

- Start the web browser.
- Enter `http://169.254.wx.yz` in the address bar and press the ENTER key:  
Here wxyz stands for the last 4 digits from serial number of the Solar-Log™. The serial number is printed on the model tag.
- The main menu of the Solar-Log™ is displayed.

## IP address that was entered during the initial configuration

- Start the web browser.
- Enter IP address from the [Initial Configuration](#) in the address bar and press the ENTER key.
- The main menu of the Solar-Log™ is displayed.

### Device URL when there are several Solar-Log™ devices on the network

- Start the web browser.
- Enter `http://solar-log-wxyz` in the address bar and press the ENTER key:  
Here wxyz stands for the last 4 digits from serial number of the Solar-Log™.  
The serial number is printed on the model tag.
- The main menu of the Solar-Log™ is displayed.

### Define the password.

If no password has been defined, the a security notice is displayed in the following window.



Fig.: Pop-up window with security information

Go to the Main Menu.

Click on "Yes" here to directly define a user password. The following configuration page appears:

Configuration / System / Access control

ACCESS CONTROL HTTPS LANGUAGE/COUNTRY/TIME LICENCES FIRMWARE

Browser access control

Password required for user access  ? Activated

User password

Repetition

Password required for installer access  ? Deactivated

NOT YET TRANSLATED

Repetition

Password required for installer/PM access  ? Deactivated

Installer password

Repetition

CANCEL SAVE

Fig.: Configuration page "Access control"

In the Access protection for the browser section, the user password can be activated and defined. Click on "save" after the defining the password.

#### Set password later (not recommended)

It is possible to define the user password later by clicking on "No" or by clicking on "No" after checking the box "I am aware of the security risks." Close the "Do not show this dialog automatically any more" window. If "Do not show this dialog automatically any more" was checked, the security warning will no longer appear each time when accessing the web interface.

As a reminder to define a password, a small red triangle appears in the top right corner. Click on this icon at any time to define the user password. Once a password has been defined, the triangle disappears.



## 11.1 Operating the Main Menu of the Solar-Log™

The main menu of the Solar-Log™ functions like a website and is divided into four main sections:

- Header bar (A)
- Left navigation (B)
- Tab (C)
- Configuration page (D)

Various control elements are used. (See the explanation below).

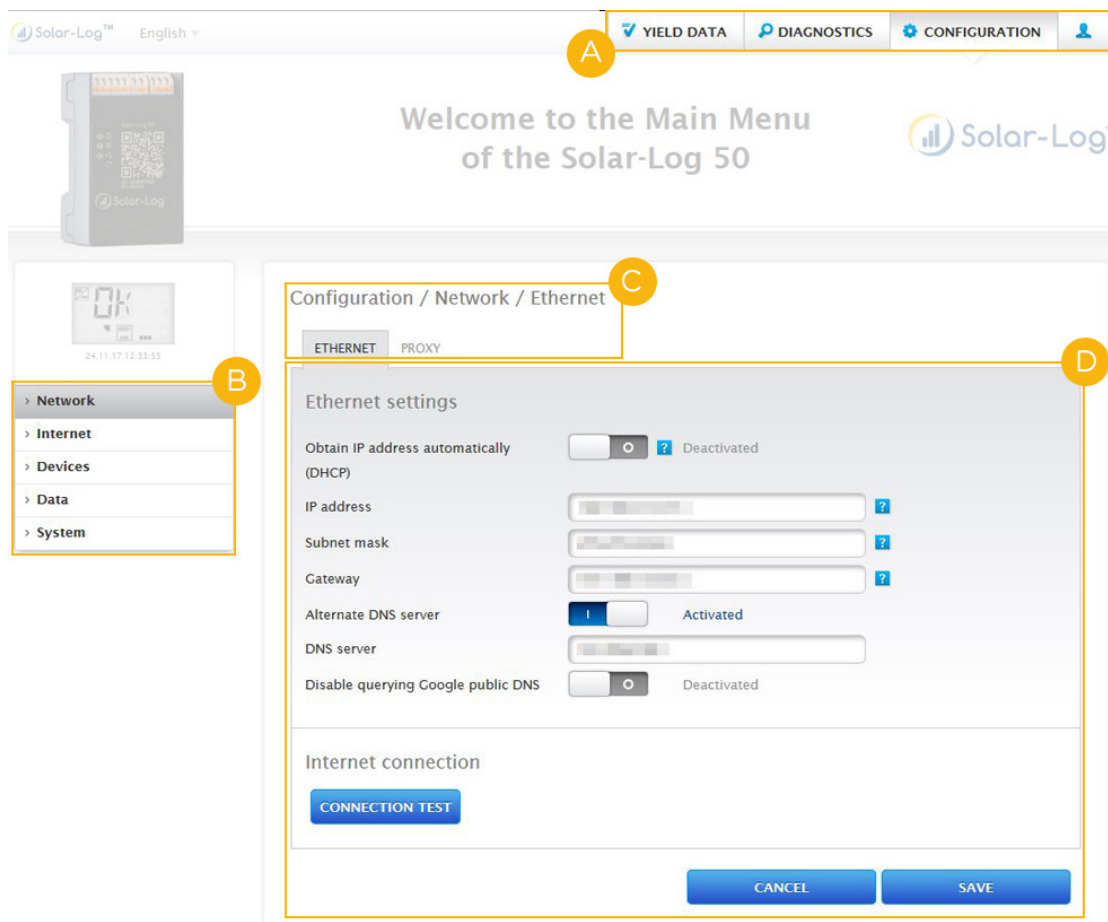

Fig.: Layout of the main menu

## 11.1.1 Control elements

The following control elements are used:

### Control elements







Control element	Meaning
	Text field
	Text field with incorrect or missing entry.
	Drop-down selection list
	Switch deactivated and activated
	The question mark boxes display additional information
	Check boxes Several boxes can be selected at one time
	Command buttons for various functions
	

Fig.: Control elements

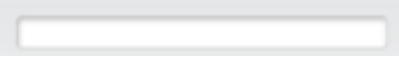
## 11.2 Explanations of the names in the main menu.

### 11.2.1 Header bar

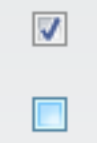
The header contains three main sections:

- **Login symbol (👤):**  
Clicking on the login symbol, for example, allows you to access the info center or assistant.
- **Configuration:**  
Here you can change the device settings as required.
- **Diagnostics:**  
Diagnostics allows you to view a summary of the device information and to create a diagnostic report.
- **Yield data:**  
Yield data allows you to view the current plant yields and the system information.

#### Note



All of the points are described below in the chapters:

- Login Section Menu
- Configuration Menu
- Diagnostics Menu
- Yield Data Menu

### 11.2.2 Left-side navigation menu

Depending on the tab selected, you can access additional functions from the navigation menu (left-side).

#### Tabs

Additional configuration sections appear according to the function selected.

### 11.2.3 Configuration Page

Here you have the option to make any necessary modifications to the configuration, to create back or to reset the device.

## 11.2.4 Login Section Menu

You can enter a password protected section by clicking on the log in button (to the right of the confirmation in the web interface) and entering your user and password. There is a gray line below the login button that indicates if you are logged in and with which user level. (Refer to the [Access Control](#) section for more information)

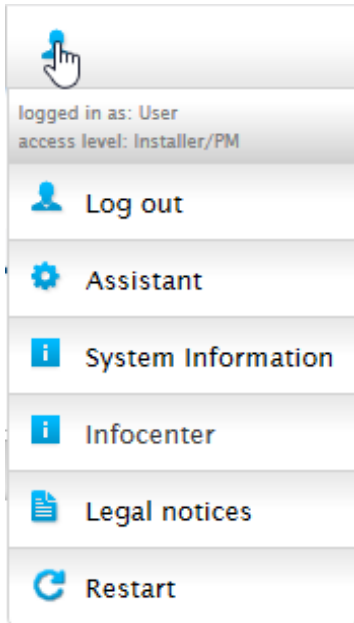

Fig.: Log in button with selection box

Additional points below the login symbol:

- Assistant
- System Information
- Info Center
- Legal notices
- Restart

### Assistant

The configuration assistant can be started directly from here.

### System Information

The following information can be viewed from system information:

About the Solar-Log™:

- Model
- Serial number
- Firmware version

Plant data:

- Plant size

Detected devices (depending on what devices are connected):

- Battery
- Hybrid System
- Sensor
- Inverter
- Meter

Data transfers:

- Last transfer with the time and date and state message (in the example: OK)

<b>About this Solar-Log™</b>	
Model	Solar-Log 50
Serial number	██████████
Firmware version	4.1.1 Build 104 - 19.04.2018
<b>Plant data</b>	
Plant size	9600 Wp
<b>Detected devices</b>	
Inverters	RS485-B: 2 x KACO
<b>Data transfers</b>	
Portal transfer	26.04.18 12:05:48 - OK

Fig.: System Info with example plant

## Info Center

Information on the following sections can be accessed here:

- Solar-Log™:  
The information about the Solar-Log™ such as the serial number, Easy Code and MAC address is located here.
- Solar-Log WEB-Enerest™:  
Here the domain, transfer type, last transfer and ordered package can be viewed.
- Licenses:  
All of the imported licenses are displayed here.
- Manuals:  
Here there is the option to access the corresponding manuals to the device and to download them.
- Firmware & Support:  
In this section, you can access the support contact form, the release notes, firmware update and FAQs.
- Solar-Log™ Shop:  
Here you can, for example, select the Solar-Log™ Shop or section for accessories.

## Legal notices

The legal notices indicate that this product uses open source components. In addition, a list of these components is displayed with the respective license texts.

## Restart

This function resets the device.

### 11.2.5 Hide arrow

The "Hide Arrow" (on the right of the header bar) allows you to increase the amount of the page displayed in the browser by hiding the Welcome header.



Fig.: Header bar with the "Hide Arrow"

### 11.2.6 New Firmware

A notification is sent via the Web browser when a new firmware is version available; a green triangle with an exclamation mark is displayed at the top in the status line. (See illustration: Signal for new firmware)



Fig.: Signal for new firmware

#### Note



The Automatic Firmware Update Check has to be activated in the [Configuration | System | Firmware](#) menu to use this function. (See illustration: Automatic Firmware Update Check with notification text displayed)

Configuration / System / Firmware

ACCESS CONTROL   HTTPS   LANGUAGE/COUNTRY/TIME   LICENCES   **FIRMWARE**

Status

Installed version

Important notice

As new firmware-versions may change existing functions and/or require changes to the configuration, it is necessary to be informed about the changes to ensure the reliable operation of the device.

Important notices are usually especially mentioned in the beginning of the release notes.

If several firmware-versions were available between the currently used version and the version that is to be installed, then all notices of the versions in between apply.

Current firmware versions and related notices can be found on our homepage under downloads.

Update firmware manually

Update firmware from hard disk  No file chosen

Check for update via Internet

Check USB drive for update

Check Firmware version automatically  Activated

**This setting allows to update Firmware versions which are defective. Generally this setting leads only to a green exclamation mark in the first line, which indicates that a newer firmware version exists.**

Fig.: Automatic Firmware Update Check with notification text displayed

The following notification text is displayed by clicking on the question mark:

"This settings allows firmware versions with critical errors to be automatically updated. However, generally, this setting only indicates that a new firmware version is available (green exclamation mark at the top).

When clicking on the green exclamation mark in the header bar, a window with the new firmware version will appear.

Selecting "OK" redirects you to the page of the Solar-Log™ for firmware updates. Selecting "Cancel" closes the window.

## 11.3 Setting up of the Solar-Log™ with the configuration assistant

After the initial set up of the Solar-Log™, the Solar-Log™ starts to ask about the following settings:

- Language
- Country and time
- Display access control

At the end, a pop-up window appears where you can start the Solar-Log™ configuration wizard. (See the following image: "Startup screen of the Solar-Log™ configuration wizard").

At this point, if you do not want to continue with the setup, the configuration wizard can be stopped by clicking on the "Cancel" button. After clicking on "Cancel," the local "Cockpit" WEB page is started. The setup can be done manually from this menu. The Solar-Log™ configuration wizard can also be started at any time from the [Configuration | System | Configuration Wizard](#) menu.

### Note



The configuration assistant can be stopped at any time by clicking on the "Cancel" button (left below the progress bar). The previously entered settings remain active.

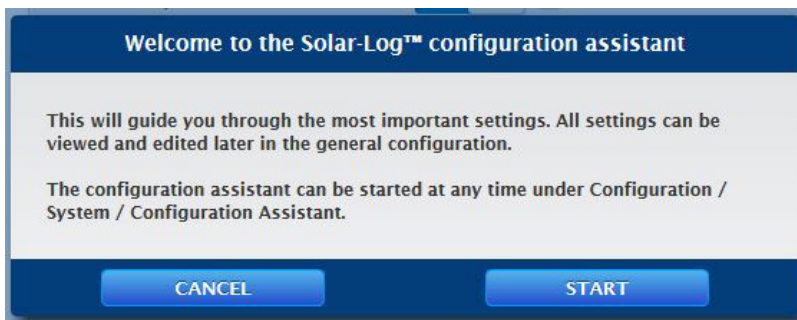

Fig.: Startup screen of the Solar-Log™ configuration wizard



Click on the "Start" button to run the configuration wizard. Once started, the **Ethernet Settings** menu appears (see image "Solar-Log™ Ethernet Settings"). In the network settings can be entered in the IP address, subnet mask and gateway boxes. The function "Obtain IP address automatically (DHCP)" can also be deactivated if the Solar-Log™ is to be assigned a fixed IP address.

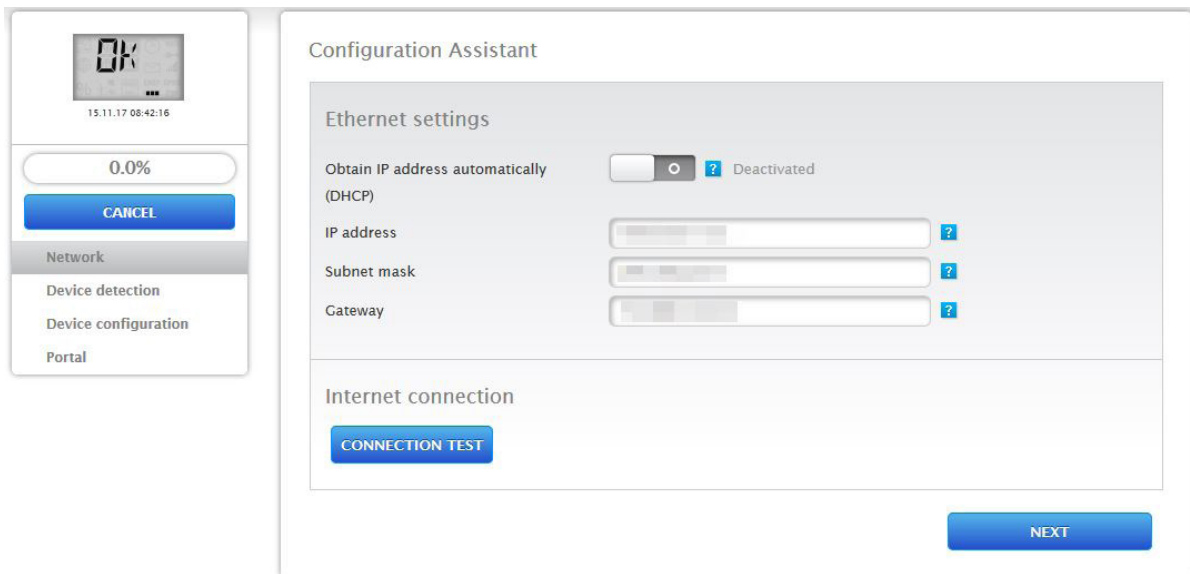

Fig.: Solar-Log™ Ethernet settings from the Solar-Log™ Configuration Wizard

Click on the "Connection Test" button in the Internet connection section to check if the settings are correct.

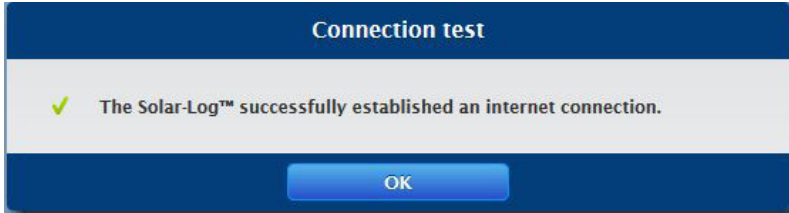

Fig.: Example of a successful connection test

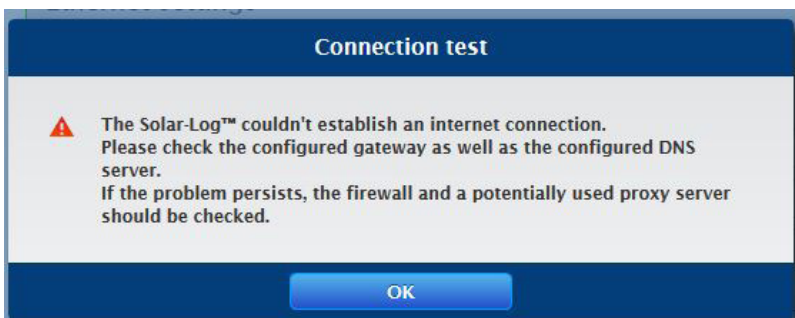

Fig.: Example of an unsuccessful connection test

Go to the Main Menu.

#### Note



All entries are saved automatically by clicking on the "Next" button. Clicking on the "Back" button allows to go back and change the settings at any time.

If the test is successful, click on the "Next" button to go to the next section. A dialog window appears. From this window, you can check if a new Solar-Log™ firmware version is available (see image "Displayed Firmware Update Window").

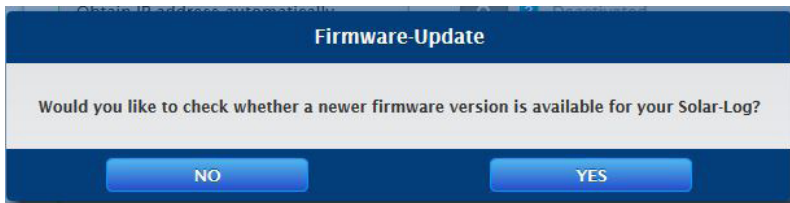

Fig.: Displayed Firmware Update Window

By clicking on "Yes," the configuration wizard checks for a new firmware version and can install it after that. At the end, the interface detection is performed. Otherwise, the interface detection menu appears by clicking on "No" for the firmware update check.

#### Note



The device detection is to be performed after the components have been connected. Otherwise the corresponding boxes for the components are grayed out.

## Interface assignment

The connected components have to be assigned in the interface assignment section.

Procedure:

- Click on the plus symbol.
- Select the device class, manufacturer, type (depending on device) and interface.
- Confirm by clicking on "OK."
- Repeat these steps for assigning the second interface.

When the selection of connected devices is complete, click on the "Start" to start the Device Detection. (See "Device Definition" chapter)

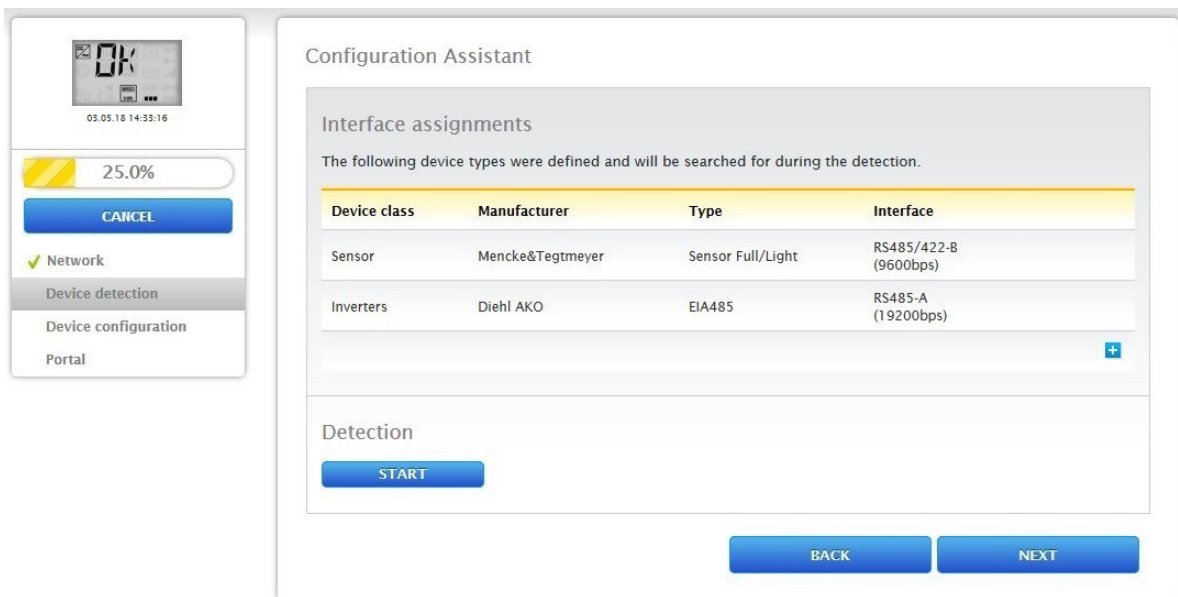

Fig.: Configuration wizard - Example - Interface Assignments

### Note



The device detection can be canceled by clicking on the "Skip" button - for example, when there is incorrect interface assignment or number of detected devices.

Go to the Main Menu.

Click on "OK" after a successful detection. Then click on "Next." The device configuration menu appears. In the device configuration, one can, for example, define the generator output, the module fields and the names of the individual components. (Also refer to the chapter "Device Configuration")

Device configuration		
Device	1: WR 1	?
Model	13000 TLD	
Address / serial number	0000.000214016	

Module field, power & label		
Maximum AC Power	12900 W	?
Pac Correction Factor	1000	?

Module field	Generator Power	Name
Device	14700 Wp ?	WR 1
MPP Tracker 1	1 4900 Wp	String 1
MPP Tracker 2	1 4900 Wp	String 2
MPP Tracker 3	1 4900 Wp	String 3

BACK NEXT

Fig.: Example – Configuration Wizard – Device Configuration

The "portal" page is loaded by clicking on "next." Here the data transfer to the Solar-Log WEB Enerest™ portal can be activated.

The box "Portal Server" appears once the data transfer to the Solar-Log WEB Enerest™ portal is activated. There are two options for entering the portal server:

- Option when the Solar-Log™ has already been registered on the portal:  
If you know the portal server, you can manually enter it. Otherwise, there is the option to automatically enter the portal server by using the "Obtain automatically" function (above the globe symbol).
- Option when the Solar-Log™ has not been registered on the portal:  
If the Solar-Log™ has not been registered on the portal, the function to obtain portal server automatically can be started with the globe symbol. The "portal server" box is grayed out and the Solar-Log™ goes into a waiting state and remains in this state until it has been registered in the Enerest portal (see the Solar-Log WEB Enerest™ User Manual, available to download from <https://www.solar-log.com/en/support/downloads/manuals>). After that the Solar-Log™ obtains the portal server automatically.

After clicking on "Next," the configuration wizard is finished and a summary is displayed. (See illustration: "Configuration Wizard Summary")

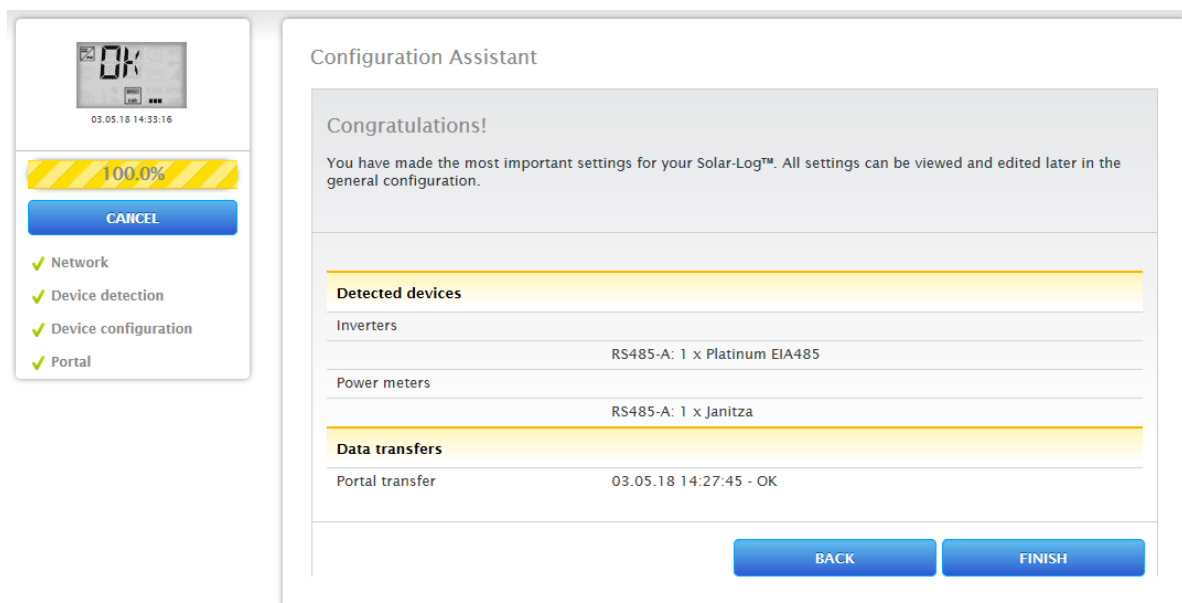

Fig.: Example - Configuration Wizard Summary

### 11.3.1 Solar-Log 50 Manual Configuration

After the device connection has been established and the Solar-Log™ has been connected to the Internet router, the basic configuration of the Solar-Log 50 is done via a web browser. All settings made at the initial startup can be changed later at any time.

#### Procedure:

- Enter <http://solar-log-wxyz> in the web browser address bar (wxyz stands for the last 4 digits from serial number of the Solar-Log™).
- A selection of display languages is displayed.
- Select the desired **Display Language**. Click on **Continue**.
- Define the country and time zone. **Continue**.
- The Access Protection menu is displayed. Click on **Continue** after defining the user password.
- The Configuration Wizard is displayed. Click on **Cancel** to perform a manual configuration.
- Select "**Configuration**" from the menu in the header bar.
- The following can be manually configured from the **Configuration** menu:
  - Network
  - Internet
  - Devices
  - Data
  - System

(For a detailed description of the configuration, refer to the chapter: "**Configuration Menu**")

## 12 Main menu

---

The main menu on the Solar-Log™ is divided into three sections:

- Configuration
- Diagnostics
- Yield data

In addition, the following sub-menus are displayed in this view:

- Cockpit
- Table

These are also located on the left side of the of the Virtual LCD Display and in additional sub-menus (depending on connected the devices) and as a selection in the main navigation menu.

### 12.1 Virtual LCD Display

The Virtual LCD Display is located above the left navigation menu and displays the notifications from the Solar-Log™ in the form of codes and symbols in addition to the date and time. The codes and symbols are described in more detail below (see chapter: "Notifications on the Virtual LCD Display"). The notications are in real time.



Fig.: Virtual LCD Display

# 13 Configuration Menu

---

The **Configuration** menu is divided into the following sub-sections:

- Network
- Internet
- Devices
- Feed-in management (with an active license)
- Data
- System

The following sub-sections of the menu will be explained separately in the following chapters.

## 13.1 Configuring network settings

Open the dialog box.

Select **Configuration | Network** from the menu.

The Network menu is divided into the following sub-sections:

- Ethernet
- Proxy

### Note



The network should always be available (24/7) to ensure comprehensive logging and reliable monitoring.

### Note



The Solar-Log 50 is equipped with a 7-day memory to prevent data transfer failures (e.g. router failure).

## 13.1.1 Ethernet

Configuration / Network / Ethernet

ETHERNET PROXY

Ethernet settings

Obtain IP address automatically (DHCP)  Deactivated

IP address  ?

Subnet mask  ?

Gateway  ?

Alternate DNS server  Activated

DNS server

Disable querying Google public DNS  Deactivated

Internet connection

CONNECTION TEST

CANCEL SAVE

Fig.: Ethernet settings

The Ethernet settings for the Solar-Log™ are adjusted in this tab.

### Obtain IP address automatically (DHCP)

Here the following options are available:

- Activate Obtain IP address automatically
- Deactivate Obtain IP address automatically.

With the default settings of the Solar-Log™, the "Obtain IP address automatically (DHCP)" option is active. DHCP also have to be enabled on the Internet router for the the Solar-Log™ to obtain an IP address. If the Solar-Log™ receives a **fixed IP address** later, the **Obtain IP address automatically (DHCP)** switch needs to be **deactivated**. The following fields need to be adjusted according the network's configurations.

### IP address

The IP addresses need to be in the same network to successfully establish a connection to the device. That means the first three blocks of the IP address are identical; only the last block differs.

An example:

192.168.100.1 for the router

192.168.100.2 for the Solar-Log™ etc.

### Subnet mask

The Subnet mask is 255.255.255.0 by default and must be the same for every device in the subnet.

### Gateway

The gateway is typically the IP address of the router to which Solar-Log™ is connected. That IP address is to be entered here.



## Alternate DNS server

In some networks, the DNS server is a separate address for resolving Internet addresses (unlike a gateway). If an Alternate DNS server is needed, switch the function to activated and enter the IP address of the DNS server.

Once finished, click on **Save**.

## Connection Test

Use the "Connection Test" button to determine if the entries are correct and if a connection can be successfully established. The message indicates if the connection was successful or not. (See the following illustrations)

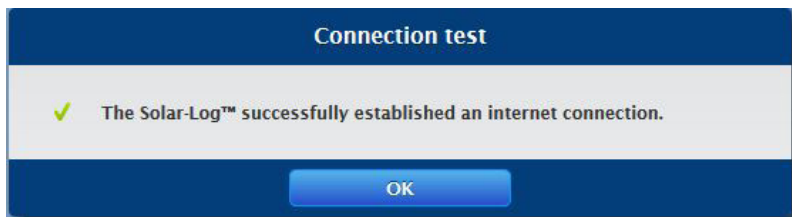

Fig.: Example of a successful connection test

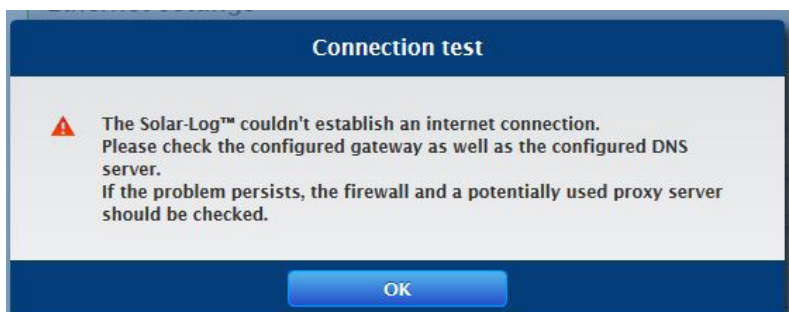
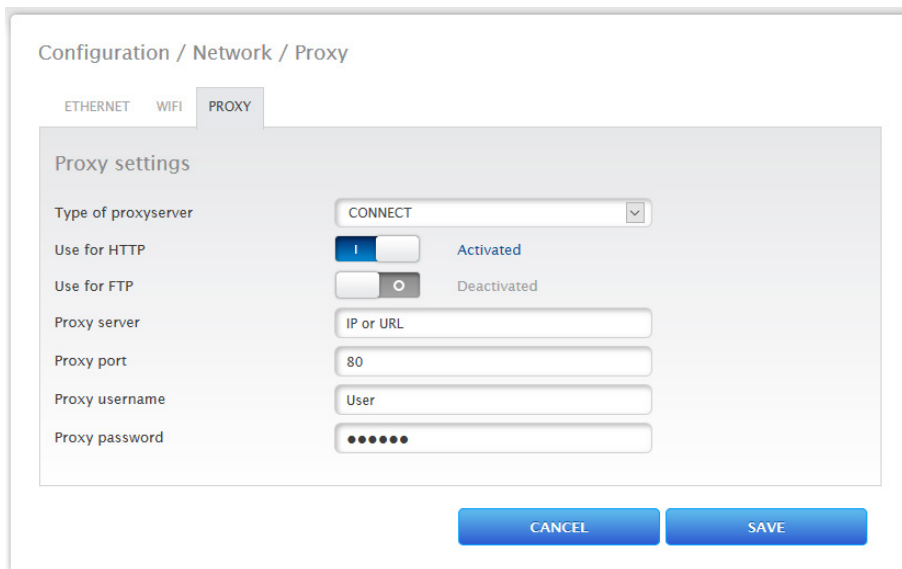

Fig.: Example of an unsuccessful connection test

## 13.1.2 Proxy



The screenshot shows a configuration window titled "Configuration / Network / Proxy". At the top, there are three tabs: "ETHERNET", "WIFI", and "PROXY", with "PROXY" being the active tab. Below the tabs, the "Proxy settings" section contains the following fields and controls:

- Type of proxyserver:** A dropdown menu set to "CONNECT".
- Use for HTTP:** A toggle switch that is turned on, labeled "Activated".
- Use for FTP:** A toggle switch that is turned off, labeled "Deactivated".
- Proxy server:** A text input field containing "IP or URL".
- Proxy port:** A text input field containing "80".
- Proxy username:** A text input field containing "User".
- Proxy password:** A text input field with masked characters (dots).

At the bottom of the window, there are two blue buttons: "CANCEL" and "SAVE".

Fig.: Example of proxy settings

The proxy function is not enabled by default. Configure the proxy in the [Configuration | Network | Proxy](#) menu.

The proxy settings need to be configured in the Solar-Log™ to enable Internet communication via the proxy server. Proxy servers are typically used in the networks of organizations and companies.

### Procedure

- When using a proxy, select [Connect Method](#).
- Enter proxy server, port, user name and password.
- SAVE the settings.

## 13.2 Internet Configuration

Select Configuration | Internet from the menu.

The following tabs can be displayed:

- Portal

### 13.2.1 Portal

The following functions are available in this tab:

- Activate/deactivate transfers
- Activated:
  - Status
  - Test

The screenshot shows the 'Configuration / Internet / Portal' window. It features a 'PORTAL' tab and a 'Solar-Log WEB Enerest™' section. The 'Activate transfers' toggle is turned on, labeled 'Activated'. The 'Portal Server' field contains 'home15.solarlog-web.de' with a globe icon. The 'Transfer interval' is set to '30 min'. Below this is a 'Status' section with 'Date (last export)' at '03.05.18 14:27:45' and 'Error (last export)' at 'OK'. A 'Test' section contains a 'Connection test' button labeled 'START'. At the bottom are 'CANCEL' and 'SAVE' buttons.

Fig.: Example of portal settings

#### Note



Please download the Solar-Log WEB Enerest™ Home User Manual from our website to efficiently use and configure the Solar-Log WEB Enerest™ Home. Located here: <https://www.solar-log.com/en/support/downloads/>

## Solar-Log WEB Enerest™ section

The following selection options are available in this section:

- Activate/deactivate transfers
- Portal server. There are two options for entering the portal server:
  - Option when the Solar-Log™ has already been registered on the portal:  
If you know the portal server, you can manually enter it. Otherwise, there is the option to automatically enter the portal server by using the "Obtain automatically" function (above the globe symbol).
  - Option when the Solar-Log™ has not been registered on the portal:  
If the Solar-Log™ has not been registered on the portal, the function to obtain portal server automatically can be started with the globe symbol. The "portal server" box is grayed out and the Solar-Log™ goes into a waiting state and remains in this state until it has been registered in the Enerest portal (see the Solar-Log WEB Enerest™ User Manual, available to download from <https://www.solar-log.com/en/support/downloads/manuals>). After that the Solar-Log™ obtains the portal server automatically.
- Transfer interval
- **SAVE** the settings.

## Status section

The following fields are displayed in the Status section:

- **Date** (Last Export)
- **Error** (Last Export)

## Test section

A connection test can be performed in the Test section. A separate pop-up window is displayed with the progress of test. The connection test also indicates if the test was successful or not. If it was not successful, it displays the error. After the tests are finished, possible causes for the connection problems are listed. (See the following example illustration).

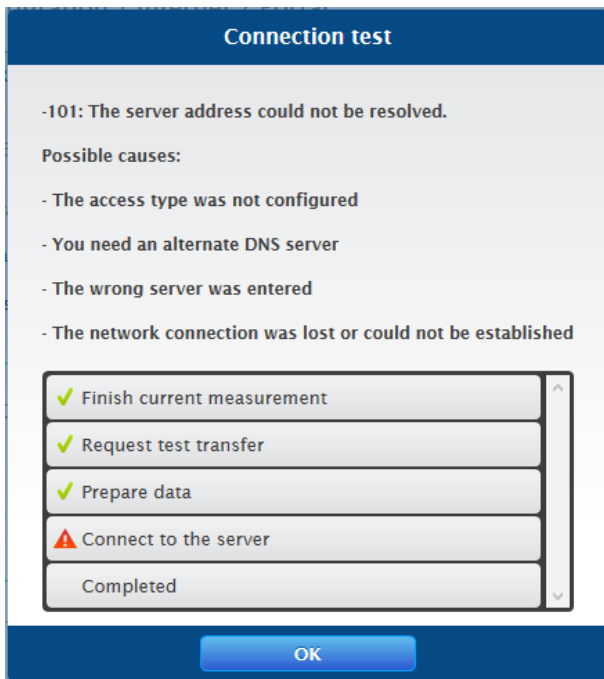

Fig.: Example - Transfer Test with an Error Image

After confirming with OK, an additional field with the status of the test is displayed in the Test section. Question marks indicate that the test was unsuccessful and possible causes are listed.

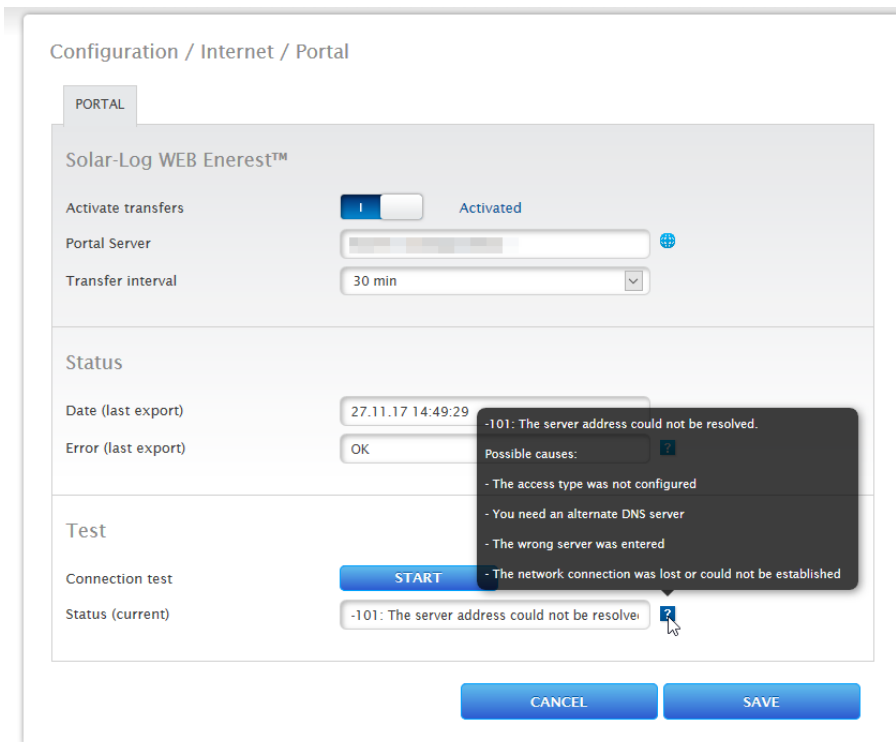

Fig.: Example - Connection Test with an Error

### 13.3 Configuring connected devices

From the menu [Configuration | Devices](#), the PV plant components connected to the Solar-Log™ can be

- defined
- detected
- and configured.

We recommend the following procedures for new installations:

- Define the interface to be used for the connected devices.
- Device detection.
- Device configuration.

### 13.3.1 Device definition

To define the device definition, go to the **Configuration | Devices | Definition** menu. The interfaces are assigned in this section.

#### Configuring the device interface section

The interface for the connected devices needs to be defined from the **Configuration | Devices | Definition | Interfaces** menu before performing a device detection.

Procedure:

- Go to the plus symbol under "Interface assignments".

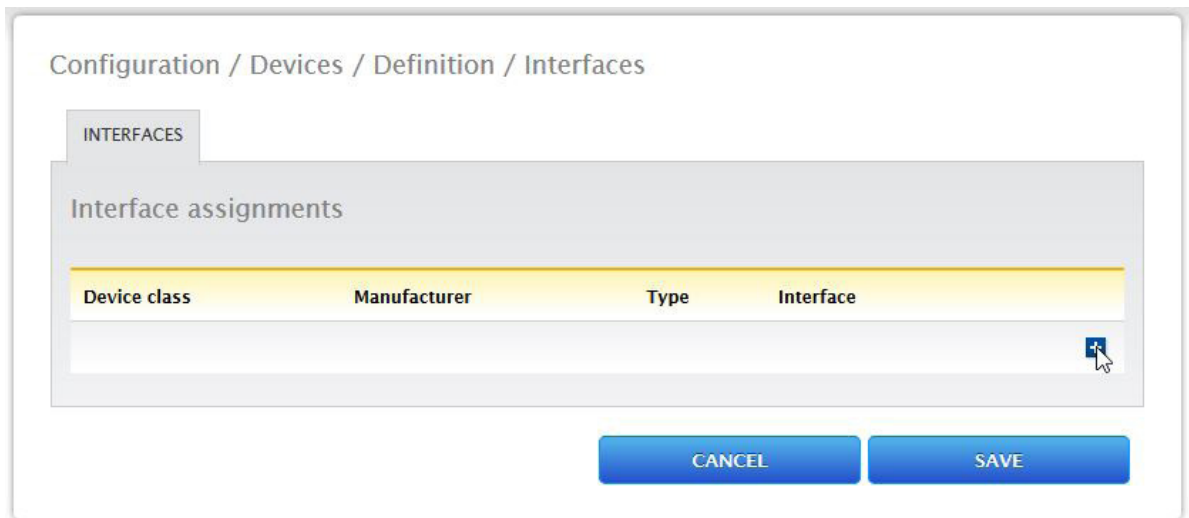

Fig.: Interface definition via the plus symbol

In the following window, the connected components can be selected in the box **Device Class**.

The following device classes can be defined:

- Battery
- Hybrid System
- Sensor
- Inverter
- Meter

Depending on the device class and/or the selected **Manufacturer**, additional boxes visible:

**Type**, **Interface** and **Baud rate**.

#### Note



Caution: Using different manufacturers on the same serial bus may cause communication problems.

Only the network interface (Ethernet) can have multiple assignments according to our component database at <https://www.solar-log.com/en/support>.

If the device class is correct, confirm the selection with **OK**. Define additional connected device classes as described.

If all of the connected components have been selected and confirmed with **OK**, an overview is displayed in

the interface assignments. (See illustration: "Overview of the selected components")

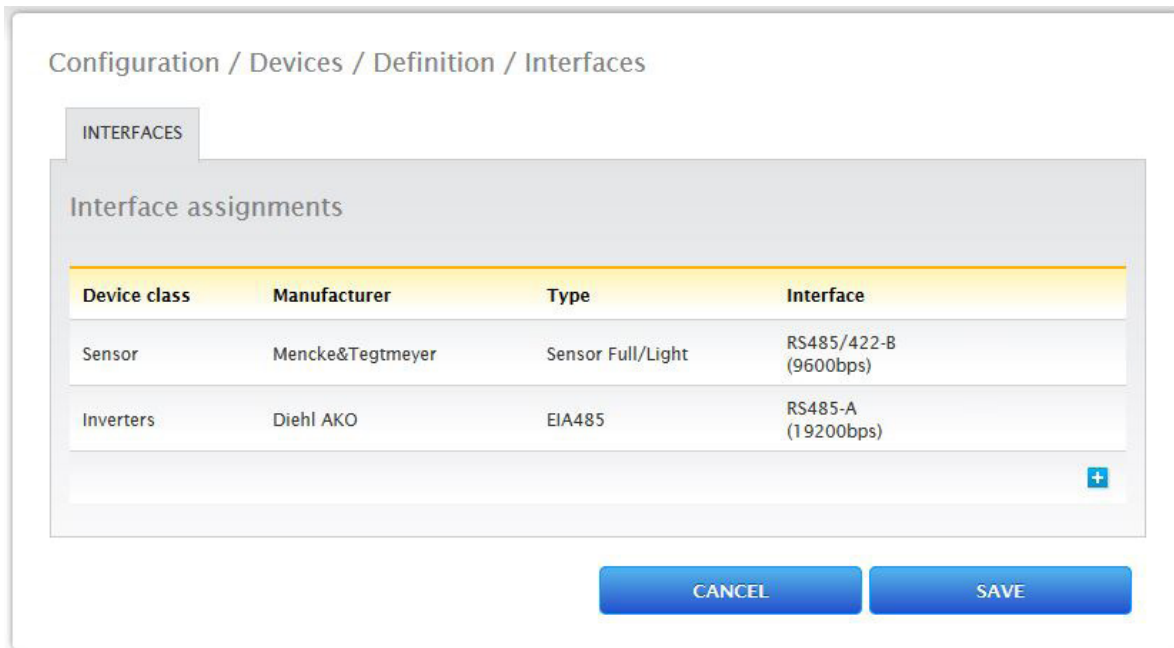



Fig.: Overview of the selected components

From the overview, there is the option to check whether the settings are correct and, if need be, adjust or delete them with the  and  symbols. (The symbols are only displayed by moving the mouse over the components.) Additionally, the following is displayed in the overview of the device interfaces:

- Device class
  - The selected devices can be seen here. In the example:
    - Sensor
    - Inverters
- Manufacturer
  - The manufacturer is displayed in this column. In the example:
    - Mencke&Tegtmeyer
    - Diehl AKO
- Type
  - The defined types are listed in this column. In the example:
    - Sensor Full/Light
    - EIA485
- Interface
  - Interface indicates which interface and baud rate the devices are using.

When all of the definitions are correct, then click on **SAVE**.

### 13.3.2 Device Detection

During the Device Detection process, all of the predefined components in the Device Definition menu which are connected to the Solar-Log™ interfaces are searched for and recognized. During the Device Detection process, the Solar-Log™'s internal data structure is prepared for these devices.

Procedure:

- Select [Configuration | Devices | Detection from the menu](#).
- The devices which were predefined in the Device Definition menu are displayed in the overview.
- [START Device Detection](#).
- The Device Detection goes from the top listed interface to the bottom listed interface when searching for devices.

The progress of the device detection is displayed in a window that automatically appears.

- [The detected devices](#) are displayed with the number of devices [per bus](#).
- If [all of the devices](#) on a bus have been [detected](#), the rest of the search can be skipped. The search is then continued on the next bus.
- The Device Detection is completed once all of the buses have been checked.  
Status message: New device detected, the data is being reformatted.



### 13.3.3 Configuring devices

After the Device Detection has been successfully completed, the detected devices have to be configured in the [Configuration | Devices | Configuration](#) menu.

Depending on the device, different settings might be needed for the configuration.

#### Procedure:

- Select the device that needs to be configured in the Device Configuration section.
- Depending on the device type, different configuration boxes appear.
- The sections below—Module Fields, Power Output and Descriptions—are largely identical. Enter the module field, connected generator power and description.

### 13.3.4 Configuring inverters

The following values have to be configured for inverters:

- Maximum AC Power
- Pac Correction Factor
- Module field
- Generator Power and MPP tracker output (according to the string plan)
- Labels or names of the inverters and/or MPP trackers.

#### Procedure:

- **Select Device.**
- Enter
- **the maximum AC power** from the inverter's data specification **in the section: Module Field, Power and Name.**
- **Enter the Pac Correction Factor** (for more information, refer to the section "Generation Information on PAC Correction Factor")
- **Define the module field.**  
Inverters can be assigned to be different module fields. See Chapter: „Modulfelder“.
- **Generator Power**  
The connected power of the individual inverters in Wp. The total power can be calculated using the formula: Module power \* Number of modules. The output does not have to be entered. It is calculated from the total generator power values that have been entered for the **Mpp Tracker**.
- **The generator power for every tracker needs to be entered if the inverter has several** MPP trackers.
- **IA distinct name can be assigned to every generator/MPP tracker in the Label box.**
- **SAVE the settings.**

### 13.3.5 Generation Information on PAC Correction Factor

At photovoltaic plants, several measuring points and power generators (inverters) are combined with one another. The Solar-Log™ evaluates this data and partially looks for any correlations.

For example, if the total amount of energy produced based on what the inverters display is compared with the values from calibrated power meters, deviations of up to 8% can arise.

In practice, meters and inverters both can display too much or too little kWh.

To correct these inaccuracies in the medium term, the Solar-Log™ firmware uses a PAC correction factor.

#### Calculating the PAC correction factor

All yield data are always stored internally without any correction factor. This factor is applied only when the data are displayed. The factor can therefore be adjusted at any time.

The formula for calculating the correction factor is as follows:

$$(\text{Yield power meter} / \text{yield inverter}) * 1000$$

If the inverter does not have a display, it is advisable to use the values which are recorded by the Solar-Log™ from a period over a week.

That is why it is recommended to leave the default PAC correction factor at 1000 initially.

The correction factor can be adjusted yearly after receiving the statement from the utility company.

Example calculation:

Inverter 1	Inverter 2	Calibrated power meter
Total energy	Total energy	Total energy
259.12 kWh	305.22 kWh	550.55 kWh
Total = 564.34 kWh		Deviation= 13.79 kWh

By comparing the values, you see that the inverters are more likely to display too much output.

#### Pac Correction Factor

Calibrated power meter total energy	Inverter total energy
550.5 kWh	564.34 kWh
Calculated PAC correction factor in the example:	
$(550.55 \text{ kWh} / 564.34 \text{ kWh}) * 1000 = 975.66$	
Rounded PAC correction factor = 976	

### 13.3.6 Configuring power meters

An operating mode needs to be assigned to power meters to configure them.

Possible operating modes for power meters:

- Generator (records the individual producers, e.g. PV inverter)
- Meter for the entire plant (records the complete PV plant output)
- Consumption meter (records the complete consumption)
- Sub-consumption meter (records the consumption from individual appliances)
- Battery (Bi-directional meter)
- Battery (Bi-directional meter)
- Deactivated

Depending on the selected operating mode and/or meter type, additional selection boxes appear, such as **Energy type** and/or **Impulse rate**.

#### Note



Several consumption meters can be defined for every plant. Their measurements are added to the total consumption.

#### Note



A sub-consumption meter is a consumption meter whose consumption has already been recorded by another meter. It is used to visualize the consumption from a particular appliance or group.

#### Procedure

- Select Device
- Select the desired operating mode from the Meter configuration section.
- If needed, assign a plant group to this meter.
- SAVE the settings.

### 13.3.7 Configure the battery

The following configurations can be made here for the connected battery.

- Battery size  
Enter the battery size in Wh in this box.
- Consumption meter includes battery charge  
This box enables recording the battery charges from the consumption meter.

#### Note



The following components always have to be used for battery monitoring to work:

- => Inverters
- => Battery
- => Consumption meter

### 13.3.8 Module Fields, Power Output and Descriptions

Depending on the device type (power meter, inverter, etc.), different settings can be adjusted from the **Module Fields, Power Output and Descriptions** menu. See the following chapters:

- Configuring inverters
- Configuring power meters

In this section, for example, the device name can be changed and the nominal power (maximum AC output) of the individual devices can be defined.

#### Module Fields

Each connected MPP tracker is assigned to a module field. Module fields are subdivided according to the type of the solar module, angles of inclination and alignment. If all modules within a system are of the same type and have the same alignment, only one module field, e.g. "1", is defined. MPP trackers that are not used must be switched off (switched to "0").

Additional module fields need to be defined for modules with different alignments and module types. Ideally, each field should be made up of at least two individual MPP trackers, which monitor each other. The module fields are used for performance monitoring.

#### Example module fields:

A plant with 23.6 kWp is divided into:

3 x SMA SB5000TL and

2 x SMA SB2500.

18 kWp is located on a barn roof with 30° inclination, 20° South-East deviation, and 5 kWp on an adjoining garage roof, 32° inclination, 0° South deviation.

This results in two module fields according to the following table:

**Division of the module fields**

Location	Inverter	MPP Tracker output	Module field
Barn	1. SB5000TL	2000	1
Barn	1. SB5000TL	2000	1
Barn	1. SB5000TL	2200	1
Barn	2. SB5000TL	2000	1
Barn	2. SB5000TL	2000	1
Barn	2. SB5000TL	2200	1
Barn	3. SB5000TL	2000	1
Barn	3. SB5000TL	2000	1
Barn	3. SB5000TL	2200	1
Garage	1. SB2500	2500	2
Garage	2. SB2500	2500	2

**Changing the device order section**

The sequential order of the inverters and other devices is determined during inverter detection. They are normally sorted by their serial number or communications address.

The order can be changed through drag and drop from the [Configuration | Devices | Configuration | Order](#) menu.

## 13.4 Feed-in management (with an active license)

### 13.4.1 Plant parameters

The plant data is entered in the plant parameters tab.

- Maximum apparent power from the generating plant  
Enter the maximum plant power output in volt-ampere (VA) here. This value has to match the value registered with the grid company.  
Typically, this calculation is based the total module power output.

### 13.4.2 Active power

The following modes are available from the **Feed-in Management | Active power** menu:

- Deactivated
- 70% fixed reduction
- 70% Fixed reduction with the calculation of self-consumption
- Adjustable reduction
- Adjustable reduction with the calculation of self-consumption
- Fixed reduction in watts
- Fixed reduction in watts with the calculation of self-consumption
- Percentage of consumption for an adjustable reduction

#### Note



The active power reduction mode that needs to be implemented for a particular PV plant is determined by the current national laws, standards and grid operator's requirements. The planner and/or installer of your plant or the respective grid operator can provide you with information regarding the mode of active power reduction that needs to be used.

#### Note



The feed-in management functions are not supported by all makes and models of inverters. Prior to installation please check whether power management and reactive power control are supported by the inverters used. Please consult our inverter database for an overview of all the inverters supported by Solar-Log™ devices and more details on supported functions of a particular inverter: <https://www.solar-log.com/en/support>.

### Interface assignments section

The inverters with their assigned interfaces that are connected to the Solar-Log™ are displayed in this section.

Select the inverter(s) to control and activate it/them.

## Dynamic control for different module orientations section

Depending on the plant, there might be different module orientations. To integrate these differences with the active power, the switch "Dynamic control for different module orientations" needs to be activated (deactivated by default). This switch is located in the [Feed-In Management | Active Power](#) menu. Activate this.

When this option is activated, different reduction commands are sent to the inverters, e.g. taking their orientation into consideration, to maximize the amount of power fed into the grid without exceeding the limit. The advantage here, for example, is that when some inverters are performing below a 70% limit, the output from other inverters can be adjusted above the 70% to balance the final output to 70%.

### 13.4.3 Active power deactivated

When this menu item is selected, active power is deactivated. However, the controllable interfaces can still be selected.

### 13.4.4 70% fixed reduction

By activating this menu item the inverter(s) are controlled to be fixed at 70% of the installed DC power. Enter the [Maximum AC Power](#) and [Connected Generator Power](#) as reference values in the [Configuration | Devices | Configuration](#) menu.

The maximum power output for the inverters can be calculated from the connected generator power value that has been entered.

#### Procedure

- Select 70% fixed reduction.
- Select the inverter(s) to control in the [Interface assignments](#) section.
- SAVE the settings.

#### Note



Changes to the [Maximum AC Power](#) of the inverter in [Configuration | Devices | Configuration](#) menu are disabled.  
Enter your password via the Log-on as Installer / PM to enable changes.

#### Note



The 70% reduction is always applied to the entire plant.  
All of the inverters are controlled on the same level by the Solar-Log™, independent of their alignments (east-west orientation). This can lead to a lower feed-in amount than the maximum allowed.

#### Example 1

DC power      12 kWp

AC power      12 kW

70% of the DC power corresponds to 8.4kW.

As the AC and DC power are identical, the down-control is correct.

### Example 2

DC power 12 kWp

AC power 10kW

70% of the DC power corresponds to 8.4kW.

For this reason the inverter controlled by the Solar-Log™ is reduced to 84% (8.4kW) and not only to 70% (7kW).

## 13.4.5 70% Fixed reduction with the calculation of self-consumption

This function is an enhancement to the 70% fixed reduction described in the previous chapter.

The Solar-Log™ needs to be linked to a consumption meter to implement this function. Please note the instructions in chapter "External power meter".

The configuration of this corresponds to that already described for the 70% fixed reduction.

### Procedure

- Select 70% Fixed reduction with the calculation of self-consumption
- Select the inverter(s) to control **in the** Interface assignments **section**.
- **SAVE** the settings.

### Note



The Solar-Log™ needs to be linked to a consumption meter to implement this function. Please note the instructions in chapter "External power meter".

The current amount of self-consumption is calculated by employing a power meter for self-consumption.

The consumption is calculated with the energy generated by the inverter.

If the difference between the current production and consumption is lower than 70% of the module's power output, the inverters are regulated accordingly, so that the amount of power at the feeding point is still only at 70% of the connected generator power.

## 13.4.6 Adjustable reduction

This function allows the maximum amount of grid feed-in power to be configured. The reduction level in regard to the amount of connected generator power can be freely defined as a percentage (X%). The Solar-Log™ only regulates the inverters when the amount of feed-in power for the grid has reached the limit.

### Procedure:

- Select Adjustable reduction.
- Enter the **percentage** for the adjustable reduction.
- Select the inverter(s) to control **in the** Interface assignments **section**.
- **SAVE** the settings.



### 13.4.7 Adjustable Reduction with the Calculation of Self-Consumption

This function allows the maximum amount of grid feed-in power to be configured. The reduction level in regard to the amount of connected generator power can be freely defined as a percentage (X%). The amount of self-consumption is taken into account for this calculation. The Solar-Log™ only regulates the inverters when the amount of feed-in power for the grid has reached the limit. If there is enough self-consumption, the inverters continue to operate without any reductions.

#### Procedure:

- Select Adjustable reduction with the calculation of self-consumption
- Enter the **percentage** for the adjustable reduction.
- Select the inverter(s) to control **in the** Interface assignments **section**.
- **SAVE** the settings.

#### Note



The Solar-Log™ needs to be linked to a consumption meter to implement this function. Please note the instructions in chapter "External power meter".

### 13.4.8 Fixed reduction in watts

This function allows the maximum amount of grid feed-in power to be configured. The reduction level in regard to the amount of connected generator power can be freely defined to a particular output level (W). The Solar-Log™ only regulates the inverters when the amount of feed-in power for the grid has reached the limit.

#### Procedure:

- Select Adjustable reduction.
- Enter the **Output (W)** for the **adjustable reduction**.
- Select the inverter(s) to control **in the** Interface assignments **section**.
- **SAVE** the settings.

### 13.4.9 Fixed reduction in watts with the calculation of self-consumption

This function allows the maximum amount of grid feed-in power to be configured. The reduction level in regard to the amount of connected generator power can be freely defined to a particular output level (W). The amount of self-consumption is taken into account for this calculation. The Solar-Log™ only regulates the inverters when the amount of feed-in power for the grid has reached the limit. If there is enough self-consumption, the inverters continue to operate without any reductions.

#### Procedure:

- Select Adjustable reduction with the calculation of self-consumption
- Enter the **Output (W)** for the **adjustable reduction**.
- Select the inverter(s) to control **in the** Interface assignments **section**.
- **SAVE** the settings.

Note



The Solar-Log™ needs to be linked to a consumption meter to implement this function. Please note the instructions in chapter "External power meter".

### 13.4.10 Percentage of consumption for an adjustable reduction

This function allows the maximum amount of power generated by the inverter to be configured. The percentage configured (freely adjustable) results in a corresponding reduction in regard to the total consumption at the inverter.

**Example:**

The total consumption of an installation is at 2000 W and the reduction of the inverters is configured to 90%, leaving 200 W. 200 W has to be purchased from the grid to cover the total consumption.

**Procedure:**

- Select the **percentage of consumption** for the adjustable reduction.
- Enter the **percentage (%)** for the adjustable reduction.
- Select the inverter(s) to control in the **Interface assignments section**.
- **SAVE** the settings.

## 13.5 Editing Data

The **Configuration | Data** menu offers several functions in regard to the data recorded by the Solar-Log™ and contains the following options:

- System backup
- Backup
- Reset

### 13.5.1 System backup

The **Configuration | Data | Backup** menu offers the following functions:

- Restore configuration from hard disk
- Save configuration to hard disk
- Save configuration to USB
- Restore configuration from USB

The system data consist of all the data that have been saved in the configuration. It is recommended always to make a backup of the system data before changing the configuration or updating the firmware.

## Restoring configuration from hard disk section

This function imports the configuration file from the solarlog\_config.dat file into the Solar-Log™.

### Procedure

- Click on **Browse**.
- The file manager of your OS appears.
- **Select the DAT file** that is to be imported.
- The selected firmware's file name is displayed.
- Click on **Upload**.
- The configuration is being imported. Please wait a moment.
- The Solar-Log™ reboots itself.

## Saving configuration to hard disk section

With the function a configuration file can be created and saved to a hard drive.

A Solar-Log configuration file has the following file name:

"solarlog\_config.dat."

### Procedure

- Click on **Prepare**.
- After the data has been prepared, the Download option is displayed.
- Click on **Download**.
- Depending on your browser settings, a window pops up with the options to open the file with a program or save file.
- Select **Save file**.
- The file is saved in the download folder.

### Alternative procedure

- Click on **Prepare**.
- After the data has been prepared, the Download option is displayed.
- Right click with the mouse on **Download**.
- Select **Save link as**.
- The file manager of your OS appears.
- Select the desired location to save the file to.
- **Select save**.
- The file is saved in the selected folder.

### Saving configuration to USB section

With this function, a backup can be saved to a USB stick which is directly connected to the device.

#### Procedure

- **Touch Save**.
- The configuration is being created. Please wait a moment.
- The progress and status of the update are displayed.  
Finish current measurement.  
Search for USB stick  
Save configuration.
- The solarlog\_config\_YYMMDD.dat file is saved in the /Backup directory of the USB stick.  
YYMMDD stands for year, month and day - each two digits, e.g. solarlog\_config\_180502.dat is then the backup from 02 May 2018.
- The configuration file can be saved elsewhere as a backup or imported into the Solar-Log™ again.

### Restoring configuration from USB section

This function imports the solarlog\_config.dat (or solarlog\_config\_YYMMDD.dat) configuration file from a USB stick which is directly connected to the device into the Solar-Log™.

#### Procedure

- Click on **RESTORE**.
- Backup files are searched for on the USB stick that is directly connected to the Solar-Log™  
First it looks in the main directory of the USB stick for solarlog\_config.dat, then it looks in the /backup directory. And lastly it looks in the backup directory for solarlog\_config\_YYMMDD.dat. When it looks for the solarlog\_config\_YYMMDD.dat. file, it loads the latest file.
- Start this search.
- When a configuration file is found on the USB stick, click on **RESTORE** to import it.  
This data is being imported.  
Please wait.
- The Solar-Log™ reboots itself.
- The configuration file was imported.

## 13.5.2 Backup

The [Configuration | Data | Backup](#) menu offers the following functions:

- Restore data backup from hard drive.
- Save data backup to hard drive.
- Save data backup to a USB stick.
- Restore data backup from a USB stick.

### Restore data backup from hard drive section

This function restores the backup file with the name solarlog\_backup.dat to the Solar-Log™.

#### Procedure

- Click on [Upload](#).
- The file manager of your OS appears.
- [Select the DAT file](#) that is to be imported.
- The selected backup's file name is displayed.
- Click on [Upload](#).
- The configuration is being imported. Please wait a moment.
- The Solar-Log™ reboots itself.

### Saving data backup to hard drive section

With the function a backup can be created and saved to a hard disk.

A Solar-Log backup file has the following file name:

solarlog\_backup.dat.

#### Procedure

- Click on [Prepare](#).
- The progress and status of the update are displayed.  
Finish current measurement.  
Search for USB stick  
Save the configuration after the data has been prepared, the Download option is then displayed.
- Click on [Download](#).
- Depending on your browser settings, a window pops up with the options to open the file with a program or save file.
- Select Save file.
- The [file](#) is saved in the download folder.

#### Alternative procedure

- Click on [Prepare](#).
- The progress and status of the update are displayed.  
Finish current measurement.  
Search for USB stick  
Save configuration.
- After the data has been prepared, the Download option is displayed.
- Right click with the mouse on [Download](#).
- Select Save link as.
- The file manager of your OS appears.
- Select the desired location to save the file to.
- [Select save](#).
- The file is saved in the selected folder.

## Saving data backup to USB section

With this function, a backup can be saved /Backup directory of a USB stick which is directly connected to the device.

### Procedure

- **Touch Save.**
- The backup is being created. Please wait a moment.
- The progress and status of the update are displayed.  
Finish current measurement.  
Search for USB stick  
Save configuration.
- The solarlog\_backup\_YYMMDD.dat file is saved in the /Backup directory of the USB stick.  
YYMMDD stands for year, month and day - each two digits, e.g. solarlog\_backup\_180502.dat is then the backup from 02 May 2018.

The Solar-Log™ backup can be copied to another storage medium or imported into the Solar-Log™ again.

## Restoring backup from USB section

This function restores a backup file with the name solarlog\_backup.dat from the USB stick connected directly to the device to the Solar-Log™.

### Procedure

- Click on **RESTORE**.
- Backup files are searched for on the USB stick that is directly connected to the Solar-Log™  
First it looks in the main directory of the USB stick for solarlog\_backup.dat, then it looks for the same file name in the /backup directory. And lastly it looks in the backup directory for the file solarlog\_backup\_YYMMDD.dat. When it looks for the solarlog\_config\_YYMMDD.dat. file, it loads the latest file.
- **Start this search.**
- When a configuration file is found on the USB stick, click on **Restore** to import it.
- The backup is being restored. Please wait a moment.
- The Solar-Log™ reboots itself.
- The configuration file was imported.

### 13.5.3 Reset

The Configuration | Data | Reset menu offers the following functions:

- Reset the yield data.
- Reset the inverter configuration.
- Restore factory settings.

#### Resetting yield data section

In certain circumstances after an inverter detection, it may occur that incorrect or unusable data is displayed. In this case, the stored data can be deleted without having to reconfigure the Solar-Log™ completely.

##### Procedure

- Click on **RESET**.
- If you are sure that the data should be deleted, click on Continue. Otherwise click on Cancel.
- The data is being deleted.
- The Solar-Log™ reboots itself.

#### Resetting inverter configuration section

If the Device Detection needs to be started again, it is recommended to delete the previous inverter configuration with this function.

##### Procedure

- Click on **RESET**.
- If you are sure that the inverter configuration should be deleted, click on Continue. Otherwise click on **Cancel**.
- The data and inverter configuration are deleted.
- The Solar-Log™ reboots itself.

#### Restore factory settings section

This function restores the Solar-Log™ to its factory settings. All of the yield data and configuration is deleted.

##### Procedure

- Click on **RESET**.
- If you are sure that the data should be deleted, click on Continue. Otherwise click on **Cancel**.
- The factory settings are being restored.
- The Solar-Log™ reboots itself.

##### Note



The network settings remain when this function is used.

## 13.6 System Configuration

The [Configuration | System](#) menu has the basic settings for the Solar-Log™ and contains the following tabs:

- Access control
- HTTPS
- Language/Country/Time
- Licenses
- Firmware

### 13.6.1 Access control

Access protection for of the Solar-Log™ can be configured in this menu. The following section can be restricted with pin codes or passwords.

- Access protection for the browser menu.

#### Access protection for the browser menu

In this section, the following parts of the Solar-Log™'s browser menu can be restricted with a password:

- User  
General access to the [Browser menu](#).
- Installer  
Access to the [Configuration](#) menu.
- Installer/PM  
Access to the [Configuration | Feed-in Management](#) menu.

The default password for access to the Feed-in Management menu is PM. Access for users and installers is not restricted.

#### Procedure

- [Activate the password restriction for the desired menus.](#)
- [Enter a secure password for each of the menus.](#)
- Enter the password again.
- [SAVE the settings.](#)



## 13.6.2 HTTPS

The following sections are located here:

- SSL certificate
- User-specific certificate

### SSL certificate

An SSL certificate is a code on the web server that secures online communication. When a web browser connects to a website, the SSL certificate provides a secure connection.

The Solar-Log™ uses such an SSL certificate. This can be imported into the web browser or the operating system. There is also the option to use your own SSL certificate instead of the Solar-Log™ certificate.

There are four different boxes under SSL certificate:

- Status:
- This indicates which certificate the Solar-Log™ is currently using.
- SSL certificate fingerprint:  
The correctness and authenticity of the certificate used can be verified by means of the fingerprint. This is done by comparing the string displayed in the field with the reference sequence in the browser.
- Issue a new certificate:  
You can use the button issue a new certificate, but the certificate currently used will be irrevocably deleted.
- Download SSL certificate:  
The Download button offers the option to download the SSL certificate and to import it into the browser or operating system.

### User-specific certificate

An user-specific certificate can be uploaded in this section. Go to "Browse" to select the certificate you want to upload.

#### Note



Please note the help texts in the individual sections.

### 13.6.3 Language/Country/Time

The following options are available from the [Configuration | System | Language/Country/Time](#) menu:

- System language of the Solar-Log™.
- Country/Location of the Solar-Log™.
- System time of the Solar-Log™.
- Time synchronization.

#### Language section

##### Procedure

- Select the desired [Language](#) in the selection menu.  
The selected display language affects the display in the web browser.
- [SAVE](#) the settings.

#### Country section

##### Procedure

- Select your [Country](#) in the selection menu.  
The country setting affects how the date, time and currency formats are displayed.
- [SAVE](#) the settings.

#### Time section

The clock time is factory-set, but it may be lost due to long periods of storage.

The time zone, date and summertime values must be set correctly, so that no incorrect statuses or results are obtained during monitoring and graph display, e.g. when e-mail messages are sent or when a curve is displayed on the day graph.

Fig.: Configuring the time on the Solar-Log™

Adjust the time in the [Configuration | System | Language/Country/Time](#) menu.

#### Adjust the new system time

##### Procedure

- The current system time is displayed.
- Enter the following format to change [the date and time](#):  
DD/MM/YY HH:MM:SS  
For example: 02.03.18 12:15:03 PM (12:15:03) for 02 March 2018 12 Hours 15 Minutes 03 seconds (12:15 p.m.)
- [SET](#) a new date and time.

## Adjust the time zone

### Procedure

- Enter the time difference in hours (time zone).  
Default: GMT +1
- Save the Entry .

## Set Day Light Saving Time.

### Procedure

- Select the corresponding Day Light Saving Time settings:  
Options: no, CEST (Central European Summer Time), USA, Australia.
- SAVE settings.

## Automatic time synchronization section

To automatically synchronize the system time, the Solar-Log™ regularly contacts a network time protocol (NTP) server.

If the Solar-Log™ is connected to the Internet via a router, the synchronization occurs during the night.

### Procedure

- Activate the Automatic time synchronization button.
- SAVE the settings.

Update now function, the time synchronization with the NTP server can be manually started. The NTP port 123 needs to be enabled in the gateway or firewall.

### Note



It is important that the time on the device is synchronized or manually set the correct time, otherwise functionality is limited (e. g. no resetting of the device) and no logging is performed.

## 13.6.4 Licenses

Certain Solar-Log™ functions have to be activated by entering a license code. You receive a license certificate after purchasing a license for a particular function. The licenses are always linked to the serial number of the particular Solar-log™ and can only be used with the device with this serial number.

Perform the following steps to purchase a license:

- Go to the license portal at <https://shop.solar-log.com>.
- Log on with your Enerest account.
- After you have to enter the serial number of the Solar-Log™, a list of compatible licenses is displayed.
- You can only select one license from the list. After the selection has been made, the web-shop payment options appear.
- After the payment confirmation, the license is valid.

Automatic import:

- Go to the Configuration | System | Licenses WEB menu of the Solar-Log™.
- Click on Synchronize.
- Now the Solar-Log™ connects to the license server and downloads all of the active licenses.

Manual import:

- Download the license file from the License portal.
- Go to the Configuration | System | Licenses WEB menu of the Solar-Log™.
- Click on the plus symbol and select the license file.

After importing the license, it is activated immediately and “**Installed**” is displayed.

The following licenses can be purchased for the Solar-Log 50 (refer also to the specifications on our website <https://www.solar-log.com/de/produkte-komponenten/solar-logTM-hardware>):

- Expansion license to 30 kWp.
- Expansion license to 10 components.
- Expansion license for power reduction:
  - X% reduction with/without self-consumption.
  - Fixed reduction with/without self-consumption.
  - Fixed reduction in watts with/without self-consumption.
  - Percentage of consumption for an adjustable reduction.
- Expansion license for all three mentioned above as multi-function license (kWp, components, power reductions).

### Note



Licenses are linked to the device (serial number). The license has to be purchased again if a device has been replaced after the warranty has expired.

## Note



If a Solar-Log™ with a license has a defect during the warranty period, a license can be requested for the replacement device. There are no costs involved, provided that the defective device is returned to Solare Datensysteme GmbH.

Fig.: Solar-Log™ with installed licenses

### 13.6.5 Firmware

The firmware tab offers the following functions:

- Information about the current firmware version.
- Firmware Update.

#### Status section

The firmware version currently installed on the Solar-Log™ is displayed. The version number contains three sections:

Version number	Build	Date
4.1.1	104	02.05.2018

## Updating firmware manually section

This function allows a new firmware to be imported from a disk.

### Note



Before manual updating, it is important to save the current system data and make a backup.

### Note



Clear the browser's cache after updating the firmware to prevent any possible display errors.

### Procedure

- Click on **Browse**.
- The file manager of your OS appears.
- Select the firmware file that is to be imported.
- The selected firmware's **file name** is displayed.
- Click on **Upload**.
- Then you are asked if system and data backups have been made. If you click "Cancel" on these queries, the process is aborted.
- The progress and status of the update are displayed.
  - Upload the file
  - Finish current measurement
  - Restart
  - Unzip the file
  - Restart
- The Solar-Log™ reboots itself.
- The current firmware version is displayed in the menu.

## Check for Update from the Internet section

With this function, the Solar-Log™ contacts the Solare Datensysteme GmbH firmware servers to check if a new version is available and offers to install it.

## Check for Update from USB

With this function, the Solar-Log™ checks the USB stick connected directly to the device if a new version is available.

When this function is used, the progress and status of the update are displayed

- Finish current measurement
- Select the USB stick.

## Automatic Firmware Updates section

With this function, the Solar-Log™ regularly checks the firmware servers to see if a new version is available. When a new version is available, it is automatically downloaded and installed during the night.

### Note



By activating this function, you give Solare Datensysteme GmbH permission to automatically load minor updates. This function is not intended to replace manual firmware updates.

# 14 Diagnostics Menu

Click on Diagnostics in the tool bar to access the Diagnostics menu.

The following menus can be selected from the [left-side navigation](#).

- Support
- Feed-in management (with an active license)

## 14.1 Accessing Support

To access the [Support](#) menu, go to [Diagnostic | Support](#).

The screenshot shows the 'Diagnostics / Support / General' interface. It features a 'GENERAL' tab and a 'System information' table with the following data:

Model	Solar-Log 50
Hardware	LED RS485A RS485B USB
Serial number	[REDACTED]
Firmware version	4.1.1 Build 104 - 19.04.2018
Revision	11936
MAC	[REDACTED]
OS	3.14.38_solarlog_0.1.1+gbd7b414 20180405133356

Below the table, there is a 'Create diagnostic report' section with a 'CREATE' button. A note states: 'It is sometimes necessary to send a diagnostic report to our support center to be able to examine certain circumstances. You can generate this report by clicking on the Generate button and then download it to your computer.'

The 'Restart device' section includes a 'RESTART' button and a note: 'Alternative to the reset button the device can also be restarted via browser'.

Fig.: Support - General

There are following sections under the [Support | General](#) menu:

- System Information:

The following information is available in this tab:

- Model (type of Solar-Log™)
- Hardware (hardware components available for the device)
- Solar-Log™ serial number
- Firmware Version and date
- Revision number
- MAC (MAC address of the device)
- OS (Operating System)
- Creating diagnostic reports:

You have the option to create and download a diagnostic report. This can be sent to Solar-Log support for analysis.



- Restart

Using the "Restart" button, the Solar-Log™ can be restarted via the WEB menu as an alternative to powering off the device itself.

### 14.2 Starting Feed-in management (with an active license)

To access the Feed-In Management menu, go to [Diagnostic | Feed-In Management](#). The inverter control can be analyzed and adjusted in this section.

Note!



The menu Feed-In Management under [Diagnostic | Feed-In Management](#) only appears if active power has been configured in the [Configuration | Feed-In Management](#) section.

**Diagnostics / Feed-In Management / Control state**

**CONTROL STATE**

**Power reduction**

Reduction type determined by:

Reduction type:

Value determined by:

Target power output (%DC):

10% diagnostic (%):

	Fronius SunSpec Modbus/SolarAPI (Ethernet)	Total
Generator power (kW)	30.00	30.00
Maximum AC power (kW)	0.00	0.00
Allowed power (kW)	21.00	21.00
Consumption (kW)	0.00	0.00
Control value AC power (kW)	0.00	---
Current power output (kW)	10.78	10.78
Control value power (% AC)	70.00	---
Current power output (% AC)	---	---
Feed-in power (% DC)	35.93 <span style="color: green;">!</span>	35.93 <span style="color: green;">!</span>

Fig.: Feed-in management - control status example

There is also a option with the [10% Diagnosis Function](#) to simulate a dynamic reduction to 10%. The values are displayed in the table.

## Note!



The 10% Diagnosis Function can only be used when the 70% Fixed Reduction has been activated.

## 14.2.1 Explanation of the Values in the Power Reduction Section

The following values are displayed in the Power Reduction section:

### Power reduction type determined by:

The currently active control source is indicated in this field.

Displayed Text	Explanation Text
PMC_NONE	No control source.
PMC_DIAG	Controlled by the diagnostic mode.
PMC_INTERN	Controlled by the internal configuration.

### Type of Reduction:

This contains the current type of power reduction that is specified by the control source.

Displayed Text	Explanation Text
PMF_NONE	No power reduction function.
PMF_PR_ERROR	An error occurred while determining the power reduction function.
PMF_PR_FIX_PERC	Fixed reduction at % DC.
PMF_PR_FIX_KW	Fixed reduction at X kW (AC)
PMF_PR_VAR_PERC	Fixed reduction at % DC with self-consumption calculation.
PMF_PR_VAR_PERC_CONS	Fixed reduction at % of the consumption.
PMF_PR_VAR_KW	Fixed reduction at X kW (AC) with self-consumption calculation.

### Value specification from:

This field indicates how the control value used was determined.

Displayed Text	Explanation Text
PMV_NONE	No control source.
PMV_CONFIG	The value is stored in the configuration.
PMV_MODE	The value can be determined by the reduction mode.
PMV_ERROR	An error occurred while determining the value.

### Target power output %:

The fields indicates the percentage of the Plant's DC power determined by the control for the target output.

The detailed values for the individual bus connections and for the total plant are displayed in the following table below. The individual buses (RS485 A and/or B) are displayed depending on which bus is assigned to control the inverters.

The column **Total** always corresponds to the plant total and reflects the value from the grid connection point. The consumption values are displayed in all of the columns, but only the plant total is taken into account.

#### Note!



The values from the individual inverters are calculated per bus and for the entire plant.

### Generator power (kW):

The generator power corresponds to the module output of the inverter that is connected to this data bus. This value results from the total of the partial outputs entered in the field generator power under configuration | Devices | Configuration. This kW values is used when calculating the output reduction (e.g.: the 70% reduction).

### Maximum AC power (kW):

The maximum AC power of the inverter(s) depends on the device. Refer to the inverter specifications for this value and configure it in the field Maximum AC power under configuration | Devices | Configuration.

### Allowed power (kW):

This kW value is the maximum amount of power that is allowed at the grid connection point. The value is calculated based on the generator output and the current power output.

### Consumption (kW):

This value is calculated from the consumption meters and refers to the entire plant. The values displayed in the respective bus column only refer to the plant total and are not taken into account in the corresponding columns. The consumption value is normally subtracted from the allowed power from the entire plant.

### Control value power (kW):

This value is calculated by the Solar-Log™ and is the maximum current power output from the inverters. It is used for the current target power output.

#### Note!



Due to technical reasons, the calculation from the Solar-Log™ is subject to a rounding factor. This may lead to deviations in the data recording.

**Current power output (kW):**

The value refers to the current output generated by the inverter per interface (column) and for the entire plant.

**Control value power (% AC):**

The Solar-Log™ calculates the control value power (kW) as a percentage of the maximum AC power and relays this to the inverters.

**Current power output (AC%):**

The value indicates the total output generated as a percentage of the maximum AC power for the inverter or all of the inverters on a bus.

**Feed-in power (% DC):**

This value is the current amount of feed-in power as a percentage of the generated output.

**14.2.2 Explanation of the Symbols in the Feed-in power (% DC) column:**



The feed-in power value is in the target power range with a tolerance of -2% to +1%.



The feed-in power value is below the target value allowed. Generally, this means that the output allowed at the grid connection point is not being achieved due to low irradiation or high self-consumption.



This means that the value is above the target value allowed.

If the red triangle is only displayed at a bus and entire plant has a green symbol, this means that only this bus is over the target value allowed. However, the plant totals do not go over the target value because of self-consumption.

## 15 Yield Data Menu

Click on Yield Data in the **tool bar** to access the **Yield Data** menu.

The following options can be selected from the left-side navigation menu.

- Current values

### 15.1 Current values

The **Cockpit** tab can be automatically selected from the **Current values** . the Dashboard view of the plant includes the following values:

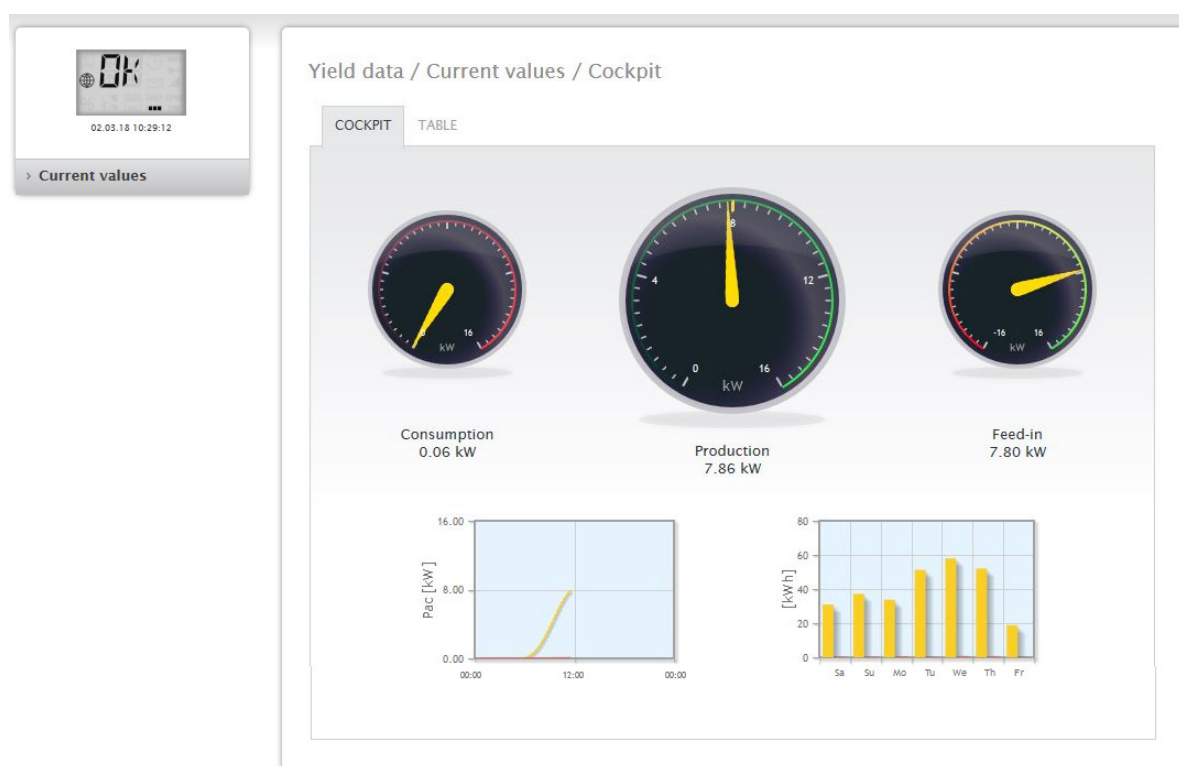

Fig.: Example plant's current values (cockpit view)

- Consumption (only when consumption meters are connected). This displays the current consumption.
- Production (power generated by the plant) + discharge \*only with a connected battery system) displays the current production and battery discharge.
- Feed-in amount (only when meters are connected). This displays the power output that is currently being fed into the grid.

There are two graphs located below the Dashboard display:

- The current day curve (graph on the left):  
There is also the option to display the previous six days as a curve in this graph. Therefore, just click on the day value in the graph on the right.
- The current day value as well as those from the previous 6 days (graph on the right):  
Move the mouse above one of the bars to display the day value. Click on one of the bars to have it display in the graph on the left as a curve.

Additional tabs can be selected in this view:

- Table

### Note!



When only consumption meters are connected to the Solar-Log™, a large consumption tachometer is displayed instead of the production tachometer in the [Current values | Cockpit](#) menu.

## 15.1.1 Table

The current values from the connected devices and status are displayed as a table in Table tab.

The screenshot shows a web interface with two tabs: 'COCKPIT' and 'TABLE'. The 'TABLE' tab is active. The table displays data for two categories: 'Inverters' and 'Consumption meter'. Each category has a header row with 'Power' and 'Status' columns, followed by a data row.

Yield data / Current values / Table		
COCKPIT	TABLE	
<b>Inverters</b>	<b>Power</b>	<b>Status</b>
WR 1	4880 W	MPP
<b>Consumption meter</b>	<b>Power</b>	<b>Status</b>
Janitza	795 W	RUNNING

Fig.: Table with the current values from an example plant

Depending on the particular device connected, the following values are displayed:

- The current output from each individual inverter.
- The total current consumption as measured by the consumption meters.
- The current irradiation per m<sup>2</sup> as measured by the sensor.
- The values from the battery with the columns Charge/Discharge and Charge Level (%).
- Device's operating status.

# 16 Symbols on the virtual LCD display

## 16.1 Meaning of the symbols on the virtual LCD display

The following symbols are shown on the Solar-Log™ virtual LCD display:

### Meaning of the symbols on the virtual LCD display







Symbol	Meaning
	Inverter
	Internet or Network
	Meter
	Booting progress
	Notifications from the Solar-Log™
	Time
	Input box for fault codes

Fig.: Virtual LCD Display - Meaning of the symbols

## 16.2 Fault messages

### Fault messages from the connected devices

If a device cannot be contacted by the Solar-Log™ (offline), the respective symbol blinks. OK is not displayed.

### Fault codes for connected devices

The respective component symbol blinks and an "E" is in the first position of the text box. A blinking code is displayed in the second position of the text box. The fault code sequence always starts with "R." That is followed by a blank and then the code numbers are displayed in the sequence.



Fig.: Example for a blinking code sequence for Internet - Fault 4

## 16.3 Normal operation

The symbol for the connected components is continuously illuminated. When there are no problems or faults, OK is displayed on the virtual LCD display.



# 17 Notifications via LED

## 17.1 LED status indications







On the front of the unit on the left, there are three LEDs that indicate the device's operating status.



Fig.: Status LEDs

Depending on the operating state, the LEDs can be lit up continuously in different colors.

### Normal operation

Symbol	Name	Color	Meaning
	Power	is green	Power supply available
	Internet	is red	No Internet connection. => Check the network cables.
	Internet	is orange	DNS failure.
	Internet	is green	Internet connection available
	Components	is red	Connection lost to at least one component.
	Components	is green	Normal operation. Connection established to the components. (The LED is also green when there is no solar irradiation, e.g. night shut-off)

# 18 Faults

## 18.1 Restarting and resetting

### 18.1.1 Reset buttons

Depending on the length that is held down, the reset button  has the following function:

- Device reset (reboot)
- Device Shutdown
- Factory settings are restored

The reset button is located below the LEDs.



Fig.: Reset button

Explanation of the reset functions:

Time		Function	Meaning
Hold down reset button for more than 5 seconds and then release it.	LED off	No function	Holding down the reset button only briefly has no function.
Hold down the button between 5 and 9 seconds and then release it.	Green	Device reset.	All settings made on the unit are maintained, as well as all data collected during run-time.
Hold down the button between 10 and 14 seconds and then release it.	Orange	Device Shutdown.	All settings made on the unit are maintained, as well as all data collected during run-time. The device is in standby mode when both of the LEDs "Components" and "Internet" are not lit. Now the Solar-Log™ can be disconnected from the power supply within 2 minutes. After 2 minutes, the device automatically reboots.
Hold the button down at least 15 seconds and then release it.	Red	The device is being restored to the factory defaults.	Both of the LEDs "Components" and "Internet" not being lit is an indication that the reset was successful. Time: Is being deleted IP address: is being set to DHCP again Passwords: Deleted Configuration data: Deleted Yield data: Deleted
Hold it down 15 seconds and then release it and then hold it down again briefly.	briefly green, then off	The factory reset was interrupted.	All of the settings are still active.

## 18.2 Fault messages

### 18.2.1 Fault messages time

These fault messages are displayed on the virtual LCD display

#### Fault messages Time

Error code	Message	Possible cause or remedy
		
1	No time/date set	Set the time and date or use the automatic time synchronization function
TM		Just like error 1 The names have been changed with Firmware 3.0.2.

### 18.2.2 Fault messages Internet

These fault messages are displayed on the VLCD display.

The Internet symbol blinks and the corresponding error code is displayed.

#### Fault messages Internet

Error code	Possible cause or remedy
	
1	Check the Internet connection and network configuration.
2	The active DNS server configured under <a href="#">Configuration   Network   Ethernet</a> is not available. Check the configurations.
3	No DNS server available Check the configurations and make sure that the correct DNS server has been entered.
4	The configured DNS server is not available. Please enter the correct DNS server.
5	DNS server could not resolve the server address. Check the DNS server and the server address.

### 18.2.3 Portal Transfer Fault messages

#### Portal Transfer Fault messages

Error code	Message	Possible cause/remedy
101	The server address could not be resolved.	The access type was not configured. An alternative DNS server is required. The wrong server was entered. The network connection was disconnected and could not be reestablished.
102	Cannot open socket.	Possible causes: Unknown. If this error continues to occur, contact our technical support.
103	Cannot connect to the socket.	Possible causes: The connection is blocked by a firewall or a router. The wrong server was entered. The server is offline.
220	Authentication failure (portal)	The portal registration was done incorrectly. The portal was not configured for HTTP transfers. The wrong server was entered.
Other	General errors	There is detailed description of this error. If this error continues to occur, contact our technical support.

# 19 Cleaning and care

---

## 19.1 Cleaning tips

Important!



Disconnect the device from the power supply before cleaning it!

- Clean the device on the outside only with a dry, lint-free cloth.
- If the device is very dirty, it can be cleaned with a slightly damp cloth and a commercially available household cleaner.

Important!



When cleaning, make sure that no moisture gets into the device!

## 19.2 Care tips

- Make sure that the device is not exposed to any moisture at the location where it is kept.
- Make sure that the device is not exposed to any heat or strong sunlight at the location where it is kept.

## 20 Disposal

---

### Caution



Solar-Log™ contains electronic components that can release highly toxic substances if burned or disposed of along with domestic waste.

The Solar-Log™ can either be disposed of at a recycling center (electrical waste) or returned to the manufacturer Solare Datensysteme GmbH.

Solare Datensysteme GmbH  
Fuhrmannstraße 9  
72351 Geislingen-Binsdorf  
Germany

## 21 Appendix

---

### 21.1 Internet ports

If the Solar-Log™ is connected to the Internet via a router, you must ensure that the following ports on the router have been unblocked for the Solar-Log™:

Function	Protocol	Port (outgoing)	Server used	Notes
Name resolution	DNS	53	According to the network configuration or 8.8.8.8 (Google Public DNS) when the name cannot be resolved with the dedicated DNS.	Normally, only the name server from the local network is used.
Time synchronization	NTP	123	0.pool.ntp.org to 3.pool.ntp.org ntp1-1.cs.tu-berlin.de bonehed.lcs.mit.edu navobs1.gatech.edu 130.149.17.8 130,207,244,240	This function ensures that the correct time is always in the logs. The Solar-Log™ has an internal clock, but it loses the time during a long power outage.
Easy Installation (WEB)	HTTP	80	pool0.solarlog-web.com to pool9.solarlog-web.com	A ping test is performed by the Easy Installation to test the Internet connection and if the DNS server functions.
	ICMP	-	solar-log.com	
HTTP Export	HTTP	80	According to the configuration.	
Firmware update	HTTP	80	pool0.solarlog-web.com to pool9.solarlog-web.com	

## 22 Dimensions

---

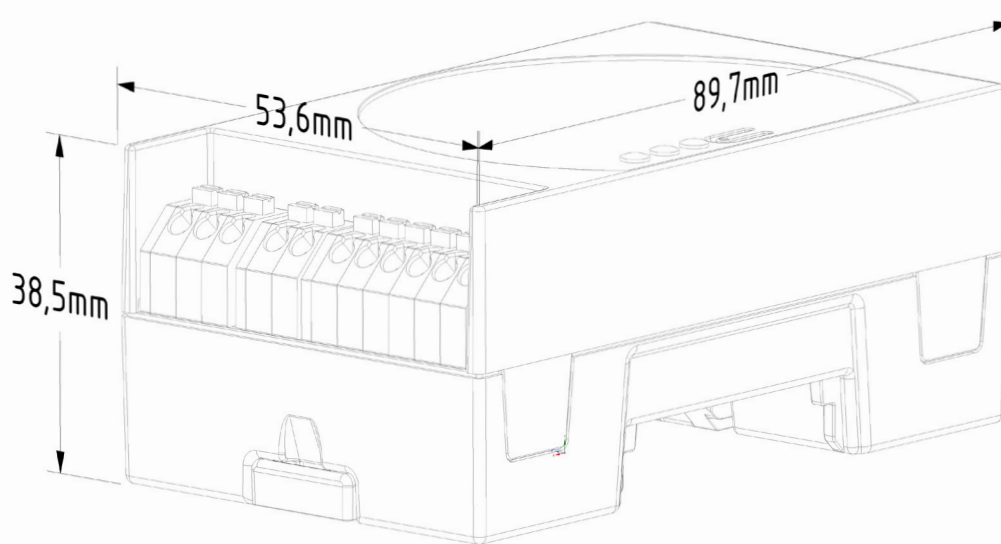



## 23 List of Figures

---

Fig.: Solar-Log 50 without extended snap-fit tabs	Fig.: Solar-Log 50 with extended snap-fit tabs	10
Fig.: Top Connections – Solar-Log 50		11
Fig.: Bottom connections Solar-Log 50		12
Fig.: Main menu of the Solar-Log 50		22
Fig.: Pop-up window with security information		23
Fig.: Configuration page "Access control"		24
Fig.: Layout of the main menu		25
Fig.: Control elements		26
Fig.: Log in button with selection box		28
Fig.: System Info with example plant		29
Fig.: Header bar with the "Hide Arrow"		30
Fig.: Signal for new firmware		30
Fig.: Automatic Firmware Update Check with notification text displayed		31
Fig.: Startup screen of the Solar-Log™ configuration wizard		32
Fig.: Solar-Log™ Ethernet settings from the Solar-Log™ Configuration Wizard		33
Fig.: Example of a successful connection test		33
Fig.: Example of an unsuccessful connection test		33
Fig.: Displayed Firmware Update Window		34
Fig.: Configuration wizard - Example - Interface Assignments		35
Fig.: Example – Configuration Wizard – Device Configuration		36
Fig.: Example – Configuration Wizard Summary		37
Fig.: Virtual LCD Display		39
Fig.: Ethernet settings		41
Fig.: Example of a successful connection test		42
Fig.: Example of an unsuccessful connection test		42
Fig.: Example of proxy settings		43
Fig.: Example of portal settings		44
Fig.: Example - Transfer Test with an Error Image		45
Fig.: Example - Connection Test with an Error		46
Fig.: Interface definition via the plus symbol		47
Fig.: Overview of the selected components		48
Fig.: Configuring the time on the Solar-Log™		67
Fig.: Solar-Log™ with installed licenses		70
Fig.: Support - General		73
Fig.: Feed-in management – control status example		74
Fig.: Example plant's current values (cockpit view)		78
Fig.: Table with the current values from an example plant		79
Fig.: Virtual LCD Display - Meaning of the symbols		80
Fig.: Example for a blinking code sequence for Internet - Fault 4		81
Fig.: Reset button		83

Solare Datensysteme GmbH  
Fuhrmannstraße 9  
72351 Geislingen-Binsdorf  
Germany  
Tel: +49 7428 9418 200  
Fax: +49 7428 9418 280  
info@solar-log.com  
www.solar-log.com  
www.solarlog-web.com

The copyright of these instructions remains with the manufacturer. No part of these instructions may be reproduced in any form or processed, duplicated or distributed using electronic systems without the written consent of Solare Datensysteme GmbH. Non-compliance resulting in contradiction of the above-mentioned specifications shall result in obligation to provide compensation for damages. Subject to change without notice.

Solare Datensysteme GmbH cannot guarantee the accuracy or completeness of the information provided and expressly refuses to accept liability for any errors or omissions in such information.

All brands and trademarks contained in this manual are the sole property of the respective manufacturer, which we respect and recognize herewith. "Speedwire" is registered trademark of SMA Solar Technology AG in many countries.

