

# PIKO CI

100 kW solar inverter



Operating manual

## Legal notice

KOSTAL Solar Electric GmbH  
Hanferstraße 6  
79108 Freiburg i. Br.  
Germany  
Tel. +49 (0)761 477 44-100  
Fax +49 (0)761 477 44-111

[www.kostal-solar-electric.com](http://www.kostal-solar-electric.com)

## Exclusion of liability

All names, trademarks, product names and other designations used in this manual may be legally protected even if not indicated as such (e.g. as a trademark). KOSTAL Solar Electric GmbH assumes no liability for their free usage. The illustrations and texts have been compiled with great care. However, the possibility of errors cannot be ruled out. The compilation is made without any guarantee.

## General note on gender equality

KOSTAL Solar Electric GmbH is aware of how language impacts on gender equality and always makes an effort to reflect this in documentation. Nevertheless, for the sake of readability we are unable to use non-gender-specific terms throughout and use the masculine form instead.

## © 2024 KOSTAL Solar Electric GmbH

All rights reserved by KOSTAL Solar Electric GmbH, including those of reproduction by photocopy and storage in electronic media. Commercial use or distribution of the texts, models, diagrams and photographs appearing in this product is not permitted. This manual may not be reproduced, stored, transmitted or translated in any form or by means of any medium, in whole or in part, without prior written permission.

Valid from version:

Firmware (FW): V3.12

Internal code (Control board CB): 011600

Communication board version (CSB): 011802

KOSTAL PIKO CI (App): V6.11.1



# Contents

<b>1.</b>	<b>General information.....</b>	<b>5</b>
1.1	About this manual .....	6
1.2	Notes in this manual .....	7
1.3	Further information .....	10
<b>2.</b>	<b>Safety .....</b>	<b>11</b>
2.1	Proper use .....	12
2.2	The operator's obligations .....	13
2.3	Qualification of the staff .....	14
2.4	Exclusion of liability .....	15
2.5	Important safety instructions.....	16
2.6	Labels on the device.....	17
<b>3.</b>	<b>Device and system description .....</b>	<b>19</b>
3.1	System overview .....	20
3.2	Device overview.....	21
3.3	Functional overview .....	22
<b>4.</b>	<b>Installation .....</b>	<b>27</b>
4.1	Transport and storage .....	28
4.2	Scope of delivery .....	29
4.3	Installation .....	30
4.4	Electrical connection.....	36
4.5	Overview of communication connections.....	41
4.6	Mounting WiFi antenna.....	42
4.7	Types of communication .....	43
4.8	Communication via LAN .....	45
4.9	Communication via RS485 .....	46
4.10	Communication via WiFi .....	48
4.11	Communication via Bluetooth.....	49
4.12	Connecting the KOSTAL Smart Energy Meter .....	50
4.13	Connecting central grid and system protection.....	56
4.14	Connecting ripple control receiver .....	58
4.15	Connecting PV modules .....	61
4.16	Initial commissioning.....	69
<b>5.</b>	<b>Operation and operating the device.....</b>	<b>72</b>
5.1	Switching on the inverter .....	73
5.2	Switching off the inverter .....	74

	1	2	3	4	5	6	7	8	9	10	11	
5.3												75
5.4												77
5.5												78
5.6												79
<b>6.</b>												<b>80</b>
6.1												81
6.2												82
6.3												83
6.4												84
6.5												85
6.6												90
<b>7.</b>												<b>102</b>
7.1												103
7.2												104
7.3												106
7.4												107
<b>8.</b>												<b>109</b>
8.1												110
8.2												111
8.3												112
8.4												113
8.5												114
8.6												117
8.7												119
<b>9.</b>												<b>126</b>
9.1												127
9.2												130
<b>10.</b>												<b>131</b>
10.1												132
10.2												133
10.3												134
<b>11.</b>												<b>135</b>
11.1												136
11.2												137
11.3												138
11.4												139



# 1. General information

1.1 About this manual.....	6
1.2 Notes in this manual.....	7
1.3 Further information.....	10



## 1.1 About this manual

Thank you for choosing a device from KOSTAL Solar Electric GmbH.

The manual contains information about to use the product safely. Read this manual in full and be sure to follow the safety notices before working with the product.

If you have any technical questions, simply contact our service hotline.

**☑ Warranty and service, Page 136**

### Validity of this manual

This manual applies to 100 kW solar inverters of the PICO CI series.

This manual is intended for operators and electricians who are entrusted with installing, maintaining and repairing the device.

The most recent version of the operating manual for the product is available in the download area at [www.kostal-solar-electric.com](http://www.kostal-solar-electric.com).

### Navigation in the document

To simplify navigation through this document, it contains clickable areas.

The table of contents takes you to the specified chapter in one click.

You can navigate to the referenced points in the document within the instruction text using the cross-references.



1

2

3

4

5

6

7

8

9

10

11

## 1.2 Notes in this manual

A distinction is made in this manual between warnings and information notes. All notes are identified in the text line with an icon.



1

2

3

4

5

6

7

8

9

10

11

## Meaning of the warnings



### DANGER

Indicates a direct hazard with a high level of risk, which, if not avoided, will result in death or serious injury.



### WARNING

Indicates a hazard with a moderate level of risk, which, if not avoided, will result in death or serious injury.



### CAUTION

Indicates a hazard with a low level of risk, which, if not avoided, will result in minor or slight injury or property damage.



### IMPORTANT INFORMATION

Indicates a hazard with a low level of risk, which, if not avoided, may result in damage to property.



### INFO

Contains important instructions for installation and for trouble-free device operation in order to avoid damage to property and financial damages.

## Meaning of symbols in warnings



Danger



Danger due to electrical shock and discharge



Danger due to burns





1

2

3

4

5

6

7

8

9

10

11

## Meaning of symbols in information notes



The symbol indicates activities that may only be carried out by an electrician.



Information or tip



Important information



Damage to property possible



## 1.3 Further information

You can also find all important documents for the product in the [download area](#).

- **Approved countries**

Overview of approved countries where the inverter complies with local requirements.

- **Approved energy meters**

Information about approved energy meters for use in combination with the device.

- **Commissioning/country setting**

Overview of country settings (sets of parameters) available in the inverter.

- **Compatible partners**

Alongside its own functions, with its inverters KOSTAL also provides the option of using a whole host of different companies to run external data visualisation and energy management or to connect up module optimisers. The list contains the compatible partners.

### Open Source licence

This product contains Open Source software, developed by third parties and licensed using vehicles including GPL and/or LGPL.

For more details on this and a list of the Open Source software used and the associated licence texts, go to the Licences section on the website (Webserver) under **Licences**.

### EU Declaration of Conformity

**KOSTAL Solar Electric GmbH** hereby declares that the described in this document complies with the basic requirements and other relevant conditions of the directives listed below.

- Directive 2011/65/EU

(RoHS) to limit the use of certain hazardous substances in electrical and electronic equipment

- Directive 2014/53/EU

(RED Radio Equipment and Telecommunications Terminal Equipment) Provision of radio equipment

You will find a detailed EU Declaration of Conformity for the product in the download area at:

[www.kostal-solar-electric.com](http://www.kostal-solar-electric.com)



## 2. Safety

2.1	Proper use .....	12
2.2	The operator's obligations.....	13
2.3	Qualification of the staff.....	14
2.4	Exclusion of liability .....	15
2.5	Important safety instructions .....	16
2.6	Labels on the device .....	17



## 2.1 Proper use

The device was produced for the following purpose:

- to convert direct current from photovoltaic systems into alternating current

The alternating current can be used as follows:

- for self-consumption
- for feed-in into the public grid

The device is only intended for the following areas of use:

- use in grid-connected systems
- use outdoors or indoors
- solely for stationary use
- all the components fitted on the device or in the system must comply with the standards and guidelines applicable at the site where the system is installed.
- it may only be used in the intended power ranges and under the permissible ambient conditions.



## 2.2 The operator's obligations

As the operator, you are responsible for ensuring that the product is used safely and as intended. This includes the following obligations:

- ensuring that staff working on and with the product have read and understood the product manual.
- ensuring that the product manual is accessible to all users.
- only using qualified staff for work on and with the product.
- instructing other product users.



## 2.3 Qualification of the staff

The following activities, which are described in this manual, may only be carried out by a qualified electrician.

- Work that may impact on the energy supply company's power supply grid at the point of energy feed-in
- Changes to parameters preset at the factory
- System installation
- System commissioning and configuration
- Maintenance work that can only be carried out by a qualified electrician.
- Servicing

The qualified electrician must have basic knowledge and knowledge of the associated specialist electrical terminology (trained according to DIN VDE 1000-10, BVG A3 accident prevention regulations or an internationally comparable standard).



## 2.4 Exclusion of liability

Any use that differs from that described in Proper use or goes beyond the stated intended purpose is considered inappropriate. The manufacturer accepts no liability for any damage resulting from this. Modifications to the device are prohibited.

The device may only be used if it is safe to operate and is in a technically perfect condition. Any instance of misuse will result in the termination of the warranty, guarantee and general liability of the manufacturer.

Only a qualified electrician may open the device. The device must be installed by a trained electrician (according to DIN VDE 1000-10 or BGV A3 accident prevention regulations or an internationally comparable standard) who is responsible for observing the applicable standards and regulations.



## 2.5 Important safety instructions

The safety instructions in this manual must be observed during all work on the device.

The product has been developed and tested in accordance with international safety requirements. Despite this, residual risks still exist and could cause personal injury and damage to property. Observe the safety notices stated in this chapter to avoid risks at all times.

### Danger of injury



#### DANGER

##### **Danger to life from electrical shock when touching live DC cables**

When exposed to light, the PV modules generate a high DC voltage that is applied to the DC cables. Touching live DC cables will result in death or life-threatening injuries from electrical shock.

- Do not touch any exposed live parts or cables.
- Before working, de-energise the device and secure it against being switched on again.
- Wear suitable protective equipment during all work on the product.



#### CAUTION

##### **Danger of burns from hot housing parts**

Housing parts can become hot during operation. Touching hot housing parts can cause burns.

- During operation, only touch the inverter's housing cover.



## 2.6 Labels on the device

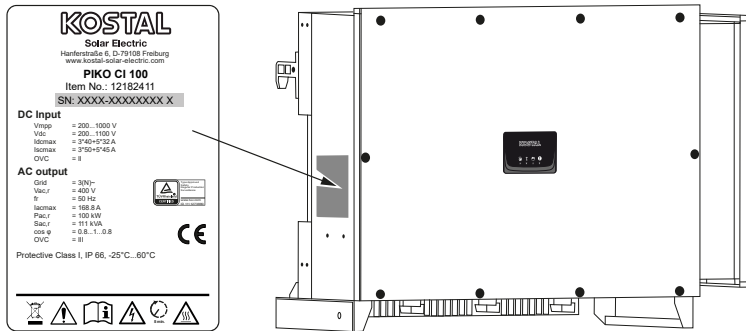

The type plate and other labels are attached to the device housing. These signs and labels must not be altered or removed.

Symbol	Explanation
	Danger notice
	Danger due to electrical shock and discharge
	Danger due to burns
	Observe and read operating manual
	Danger due to electrical shock and discharge. Wait five minutes (discharge time of the capacitors) after shutdown
	Device must not be disposed of with household waste. Observe the local application of disposal requirements.
	CE marking The product satisfies the applicable EU requirements.



1

2

3

4

5

6

7

8

9

10

11

Symbol	Explanation
	Additional earth connection



# 3. Device and system description

- 3.1 System overview ..... 20
- 3.2 Device overview ..... 21
- 3.3 Functional overview..... 22

### 3.1 System overview

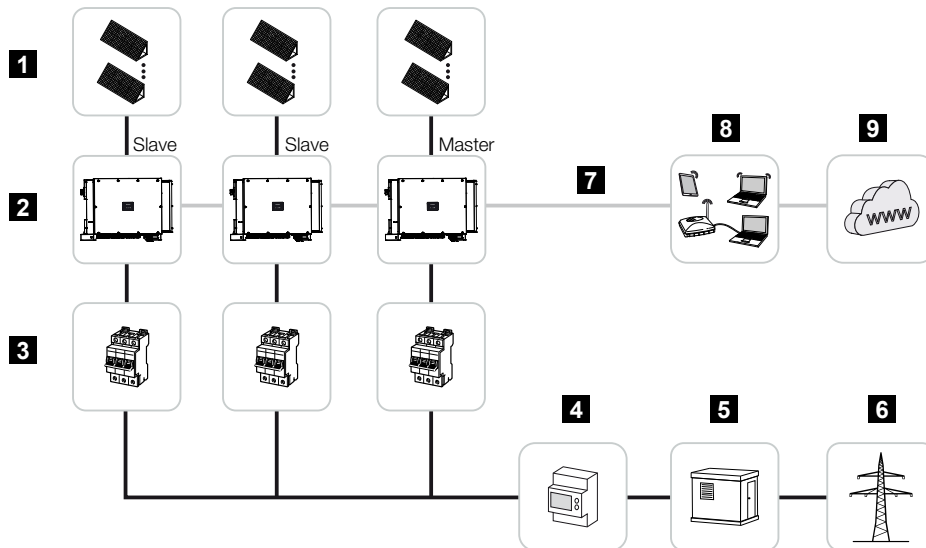

- 1 PV strings
- 2 Inverter
- 3 AC line circuit breaker
- 4 Energy meter
- 5 Distributor
- 6 Public grid
- 7 Communication connection (optional)
- 8 Router, PC connection
- 9 Internet

## 3.2 Device overview

### PIKO CI 100 inverter

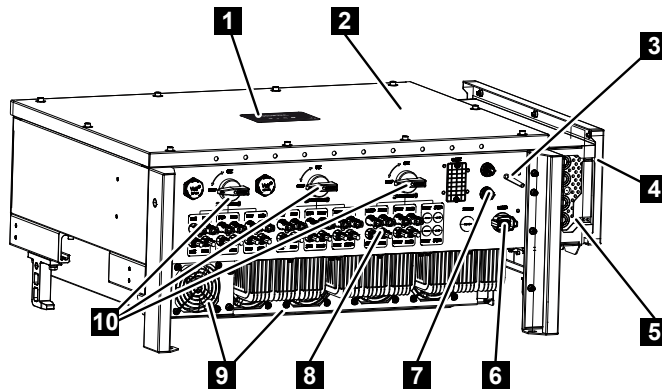

- 1 Status LED
- 2 Cover
- 3 WiFi antenna
- 4 AC terminal compartment
- 5 Cable opening for mains cable
- 6 Connection panel (RS485, RSE, NAS)
- 7 Connection (LAN)
- 8 Connections for PV modules
- 9 Fan
- 10 DC switch

### Status LED

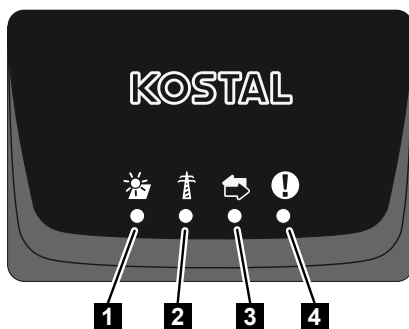

- 1 Status of PV modules
- 2 Status of grid
- 3 Status of communication
- 4 Warning message



## 3.3 Functional overview

The inverter converts energy from the connected PV modules into alternating current and feeds this into the public grid.

### Three-phase alternating current

The inverters generate three-phase alternating current and, with their high output power, are optimised for use in medium and large PV systems. This makes them suitable for solar power plants, electricity farms and similar applications. The inverters can be operated in TT, TN-C, TN-S and TN-C-S grids.

### Wireless commissioning

Commissioning is undertaken wirelessly using tablets or smartphones. The app is available for this purpose, which you can download free of charge from the App Store.

### Recording power generation

By connecting an external energy meter, the inverter can monitor the energy flow and optimally control the output power according to grid requirements.

### Communication

The inverter has various interfaces for communication purposes. These establish a connection to other inverters, sensors, energy meters or a link to the Internet.

- RS485/Modbus (RTU)

Data loggers or energy meters are connected to the Modbus interface to record the energy flow.

- LAN or WiFi can be used to connect the inverter to the local network via which it can then access the Internet and solar portal.

All data is transmitted encrypted.

For local access to the inverter:

- Bluetooth connection

Examples of what can be achieved via the and Bluetooth connection include initial commissioning or configuring the inverter.



## Central grid and system protection

A remote connection enables connection to a circuit breaker and thus the implementation of central grid and system protection as required by technical regulations of the grid operators.

## Ripple control receiver

For systems in which the grid operator controls the feed-in capacity using ripple control receivers, the inverter has the required digital inputs.

## App functions

The app, which is available free of charge, provides a graphical user interface. The app is used to commission and configure the inverter and to display its status:

- Log in on inverter
- Log in as system operator or installer
- Status request
- Current feed-in values at grid connection
- Display log data / events
- Inverter version display
- Inverter configuration  
(e.g. LAN connection, setting up the energy meter, etc.)



1

2

3

4

5

6

7

8

9

10

11

## KOSTAL Solar Portal

The KOSTAL Solar Portal allows operation of the inverters to be monitored via the Internet. This protects your investment in a PV system against yield losses, e.g. through active e-mail alerts if events occur.

Registering for the KOSTAL Solar Portal is free of charge at [www.kostal-solar-portal.com](http://www.kostal-solar-portal.com).

Functions include:

- Worldwide online access to the portal
- Graphic representation of the power and yield data
- Visualisation of data and thus being made aware of how to optimise self-consumption
- Notification of events by e-mail
- Data export
- Sensor evaluation
- Display and proof of a potential active power reduction by the grid operator
- Storage of log data for long-term and reliable monitoring of your PV system
- Providing system data for the

Additional information about this product is available on our website

[www.kostal-solar-electric.com](http://www.kostal-solar-electric.com) under **Products > Monitoring software > KOSTAL Solar Portal**.







1

2

3

4

5

6

7

8

9

10

11

## Event codes

Events or faults during operation are stored in the inverter's event memory and transmitted to the or can be queried via the app.

For more information: [📄 Event codes, Page 119](#).

## Service concept

For service purposes the event codes can be read out via the app or the . Your installer or service partner can then decide what action to take before on-site deployment. In this way, multiple on-site deployment can be avoided.



## KOSTAL Solar Plan configuration software

Our free software simplifies the inverter layout process.

Just enter the system data and individual customer data and receive a recommendation for a KOSTAL solar inverter tailored to the planned solar system. All KOSTAL solar inverters are considered for this. In addition, the customer's electricity consumption is considered and the possible self-consumption and potential self-sufficiency quotas are displayed using standard load profiles.

Self-consumption and potential self-sufficiency are displayed.

The covers the following areas of the inverter layout:

- **Rapid layout**

Manual inverter layout taking account of the inverter specifications

- **Layout**

Automatic PV inverter layout with possible consideration of power consumption.

- **Storage layout**

Automatic hybrid/storage inverter layout with possible consideration of power consumption.

As well as providing an improved inverter layout, the also supports preparing quotations. Customer, project and installer data is added to the technical data entered by the user and is included with the quotation as a PDF overview. The planning data can also be saved in a project file and edited if required.

You can find additional information about this product on our website [www.kostal-solar-electric.com](http://www.kostal-solar-electric.com) in the section *Installer portal*.



KOSTAL Solar Plan



# 4. Installation

4.1	Transport and storage.....	28
4.2	Scope of delivery .....	29
4.3	Installation.....	30
4.4	Electrical connection .....	36
4.5	Overview of communication connections .....	41
4.6	Mounting WiFi antenna .....	42
4.7	Types of communication .....	43
4.8	Communication via LAN.....	45
4.9	Communication via RS485.....	46
4.10	Communication via WiFi.....	48
4.11	Communication via Bluetooth .....	49
4.12	Connecting the KOSTAL Smart Energy Meter .....	50
4.13	Connecting central grid and system protection .....	56
4.14	Connecting ripple control receiver .....	58
4.15	Connecting PV modules.....	61
4.16	Initial commissioning .....	69



1

2

3

4

5

6

7

8

9

10

11

## 4.1 Transport and storage

The function of the inverter has been tested and it has been carefully packaged prior to delivery. Upon receipt, check the delivery for completeness and any transport damage.



### POSSIBLE DAMAGE

#### Damage to the device

Potential risk of damage when setting the inverter down. Whenever possible, place the inverter on its back after unpacking.

- Store all components of the inverter in the original packaging in a dry and dust-free place if the inverter is to be stored for a longer period of time before installation.
- Replace the packing material if it has been damaged.
- To transport the inverter, only handle it at the points indicated. Do not touch the AC connection area because this may become damaged.



### CAUTION

#### Danger of injury!

The inverter is very heavy.

- Do not lift or transport the inverter alone. To prevent injury, get another person to help you.

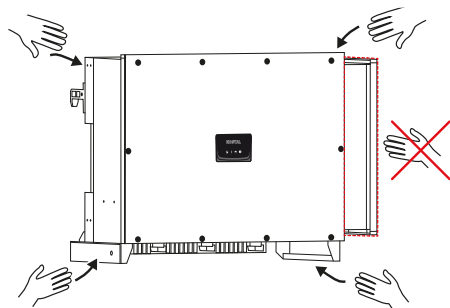

- Do not tip the inverter onto its side. Avoid tilted positions.
- Only place the inverter down on its back.
- Do not place the inverter down on its side or on the top.

## 4.2 Scope of delivery

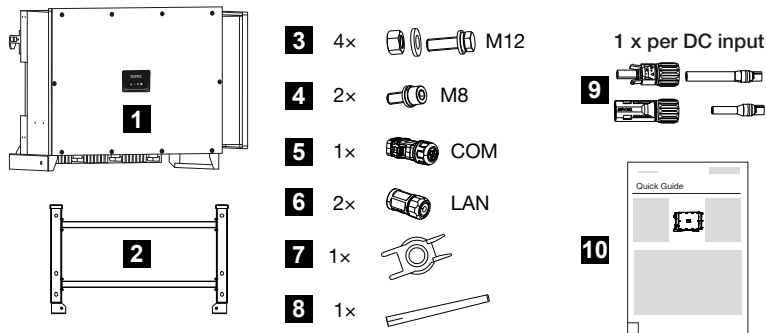

- 1 Inverter
- 2 Bracket
- 3 Mounting kit: 4x M12 screws with nut and washer
- 4 2 x M8 lock screw
- 5 1 x communication plug
- 6 2 x caps for LAN
- 7 Removal tool for DC plug connectors
- 8 WiFi antenna
- 9 DC plug connector (each DC input: 1x plug, socket)
- 10 Quick start guide

## 4.3 Installation

### Selecting the installation site



#### IMPORTANT INFORMATION

##### Loss of warranty due to incorrect installation

Observe these instructions when selecting the installation site. Failure to observe these instructions may limit guarantee claims or render them fully null and void.

- Be absolutely sure to maintain the clearance around the inverter in order that the inverter remains cool.
- To mount the inverter, use the wall mount and fastening screws that are suitable for the substrate.



Install the inverter indoors.



Install the inverter in a protected outdoor area.



Protect the inverter from direct precipitation.



Protect the inverter from coarse soiling, e.g. leaves.

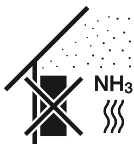

Protect the inverter against dust, contamination and ammonia gases. Rooms and areas containing livestock are not permitted as installation sites.



Do not install the inverter in potentially explosive areas.



1

2

3

4

5

6

7

8

9

10

11



-25 ... +60 °C

The ambient temperature must be between -25 °C and +60 °C.



0...100 %

The air humidity may be between 0% and 100% (condensing).

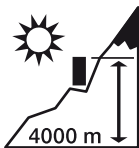

Inverter may only be installed up to an altitude of 4000 m.

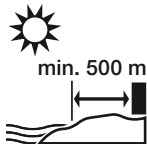

Outdoors in salty areas, do not install device any closer than 500 m from the coast. The device may be corroded in such areas. Areas close to the coast with a sea breeze or regions exposed to onshore winds are considered to be areas affected by salt. The region may vary depending on weather conditions (e.g. typhoons and monsoon rains) or topography (e.g. near dams and mountains).



A sufficient safety distance from flammable materials and potentially explosive areas in the vicinity must be ensured.



Mount inverter on a stable installation surface that can safely bear the weight. Plasterboard walls and wood planking are not permitted.

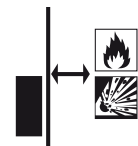

Do not install the inverter on a flammable installation surface.

**WARNING! Risk of burns from hot parts on the inverter! Some of the inverter components can reach temperatures of over 80 °C during operation. Select the installation site in accordance with the information provided in these instructions. Always keep the ventilation openings clear.**

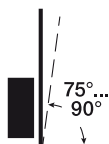

Install the inverter vertically. Tilted position up to 15° is permitted.

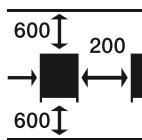

Maintain minimum distances and the necessary clearance.



1

2

3

4

5

6

7

8

9

10

11



The inverter makes noise during operation. Install inverter in such a way that people are not disturbed by operation noises.

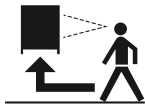

The inverter must be easily accessible and the status LED must be easy to read.



Install the inverter out of reach of children or other unauthorised persons.



Lay cables with UV protection or use UV-resistant cables.





## Installation dimensions



### IMPORTANT INFORMATION

Be absolutely sure to maintain the clearance around the inverter in order that the inverter remains cool.

For installation, use retaining bolts that are suitable for the base, the weight of the inverter and the ambient conditions.

Requirement of retaining bolts:

Ø 12 mm, 8.8, A2-70

### Installation dimensions with bracket

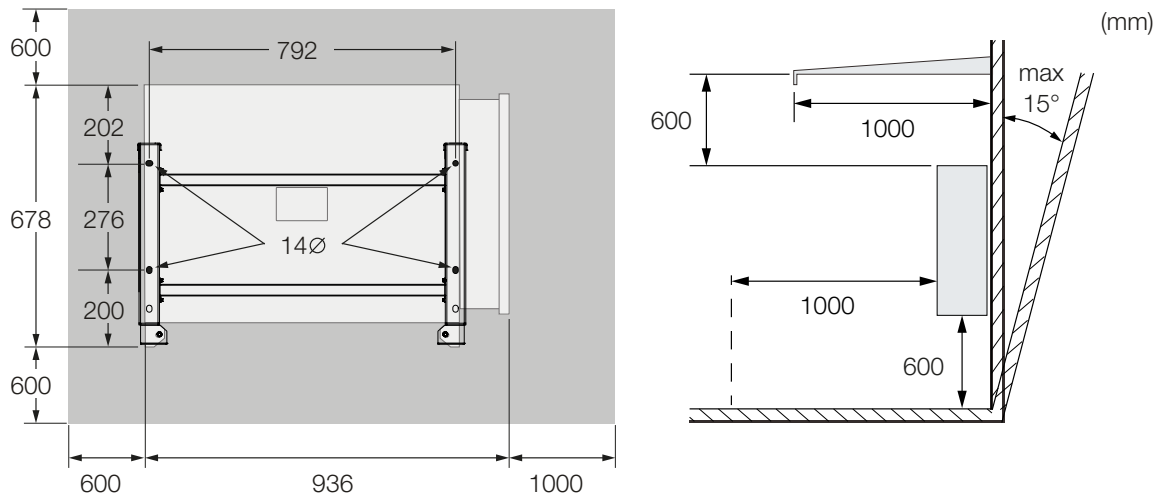

### Multiple inverters next to each other – spacing



### IMPORTANT INFORMATION

The values given are minimum distances. Increase the distances if the thermal conditions in the installation environment require it, e.g. in case of unfavourable ventilation or strong sunlight.



1

2

3

4

5

6

7

8

9

10

11

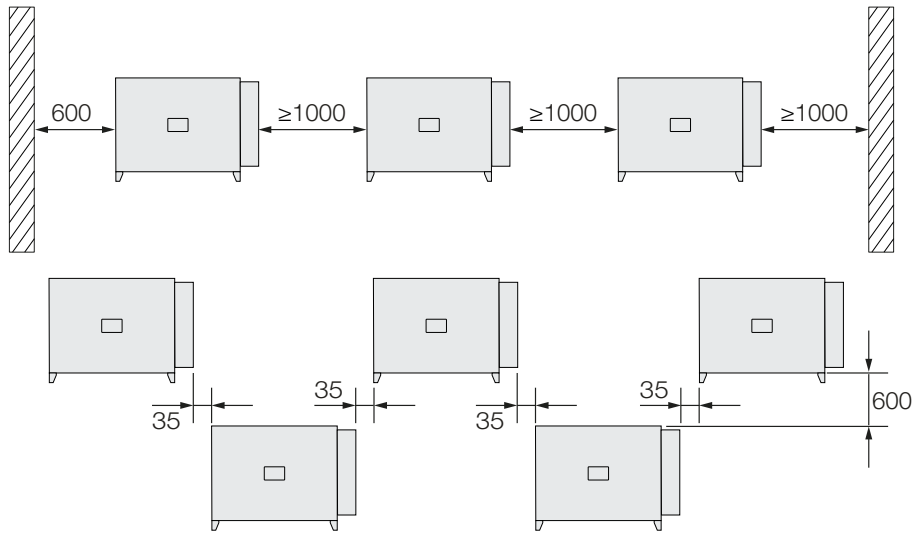



1

2

3

4

5

6

7

8

9

10

11

## Installing the inverter

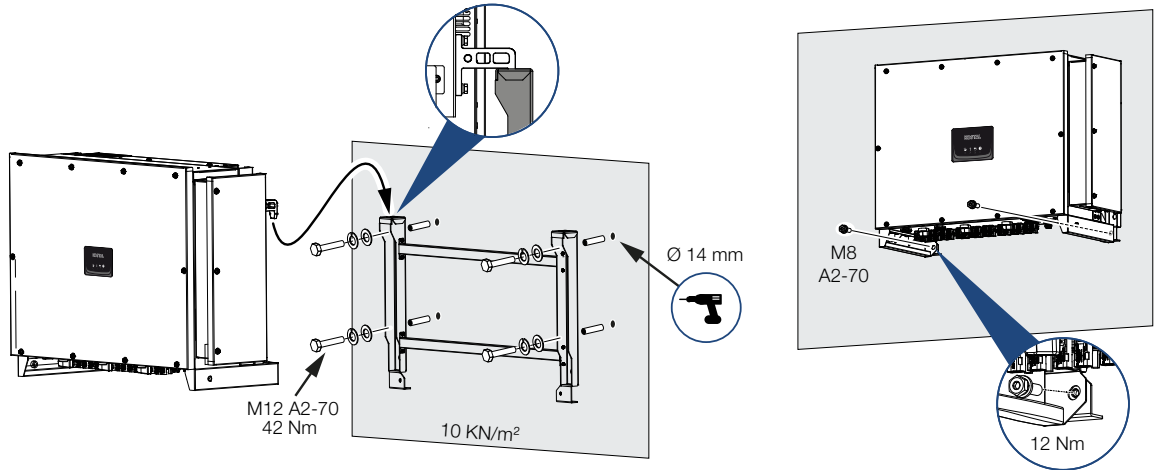

1. Install the inverter on a solid wall or on a stand. Observe the prescribed distances and other specifications.



### POSSIBLE DAMAGE

#### Damage to the inverter

If the wrong fastening material is used, the inverter may fall down.

- Install the inverter using suitable fastening material, which is suitable for the substrate.

2. Install the bracket on the base.
3. Lift the inverter onto the bracket.



### CAUTION

#### Danger of injury!

The inverter is very heavy.

- Do not lift or transport the inverter alone. To prevent injury, get another person to help you.

4. Make sure that the inverter is correctly seated and cannot slip off the bracket.
5. Install the lock screws.
- ✓ The inverter is installed.

## 4.4 Electrical connection

### Overview

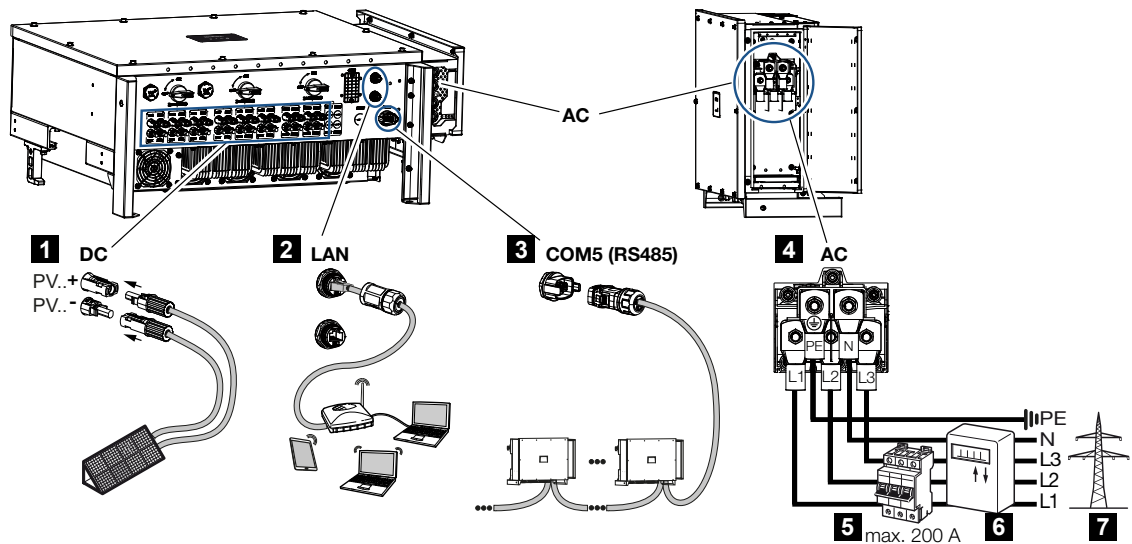

- 1 Connections for PV modules
- 2 RS485 communication connections
- 3 LAN communication connections
- 4 AC connection
- 5 Line circuit breaker
- 6 Energy meters (e.g. KOSTAL Smart Energy Meter)
- 7 Public grid

### Cable specification

#### AC grid connection

Select the conductor cross-section according to the rated output current and the type of routing.

#### **i** INFO

For outdoor installation, use UV-resistant cable. Alternatively, lay the cable protected from solar radiation.

The 4-wire AC connection (3L/PE without N) is only possible in symmetrical networks.

Take into account necessary reduction factors for ambient temperature and accumulation (when laying several cables without spacing).



Example: Ambient temperature 40 °C: Reduction factor 0.87 (according to DIN VDE 0100-520 / HD 60364-5-52).

#### AC cable specifications (grid connection)

Connection method	4-wire (3L/PE without N) or 5-wire (3L/N/PE)
Cable length	max. 200 m
Material	Copper/aluminium
Wire cross-section	Copper: 70 – 240 mm <sup>2</sup> /aluminium: 95 – 240 mm <sup>2</sup>
Cable diameter	24 – 69 mm
Wire diameter	14 – 32 mm
Additional PE connection	≥ 35 mm <sup>2</sup> (wire cross-section x 0.5)

#### DC cable specifications (PV connection)

Cable type	Solar cable e.g. PV1-F
Wire cross-section	4 – 6 mm <sup>2</sup>
Cable diameter	6 – 8 mm

### Connecting mains cable

1. Disconnect the power supply from the mains.



#### DANGER

#### Risk of death due to electrical shock and discharge!

De-energise device and secure against being switched on again.

2. Secure AC connection against being switched on again.
3. Switch the DC switch on the inverter to **OFF**.
4. Correctly lay the mains cable from the power distributor to the inverter.



#### IMPORTANT INFORMATION

Whenever working on the inverter, only ever use insulated tools to prevent short-circuits.

5. Install the necessary safety devices – line circuit breakers, residual current circuit breakers – in the mains cable.

**IMPORTANT INFORMATION**

Make sure that the phases of the AC terminal and in the mains supply match.

This product may generate a direct current in the outer protective earthing conductor. If protective residual current devices (RCD) or residual current monitoring devices (RCM) are used, only type B  $\geq 300$  mA RCDs or RCMs are permitted on the AC side.

If type A RCD compatibility is activated in the device, a type A RCD can also be used.

**CAUTION****Risk of fire due to overcurrent and heating of the mains cable**

If mains cables are too small, they can heat up and cause a fire.

- Use a suitable cross-section
- Install line circuit breaker to secure against overcurrent.

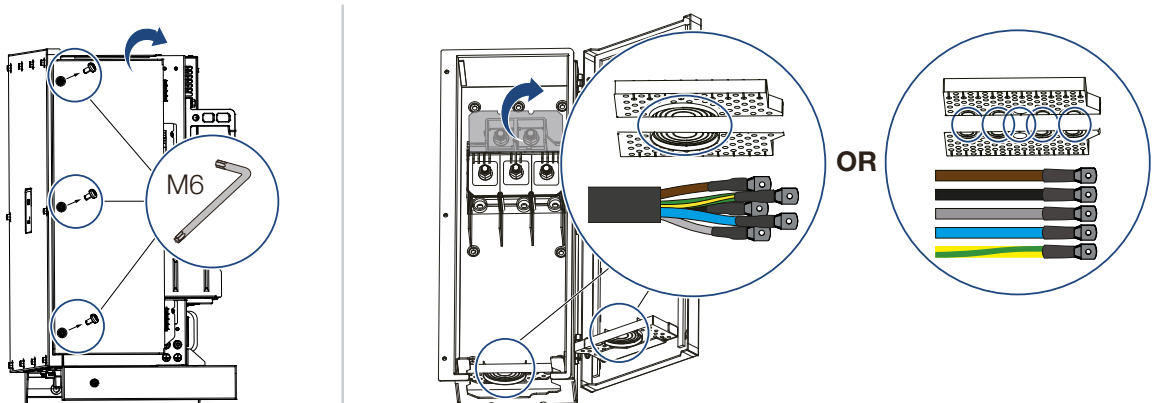
**1. Screwing on AC terminal compartment**

2. Use cable gland to suit the cable type.
3. Strip insulation off mains cable.
4. Fit suitable heat-shrinkable sleeves onto the wires. Strip insulation off ends of conductors and crimp the cable ring lug onto the ends of conductors.

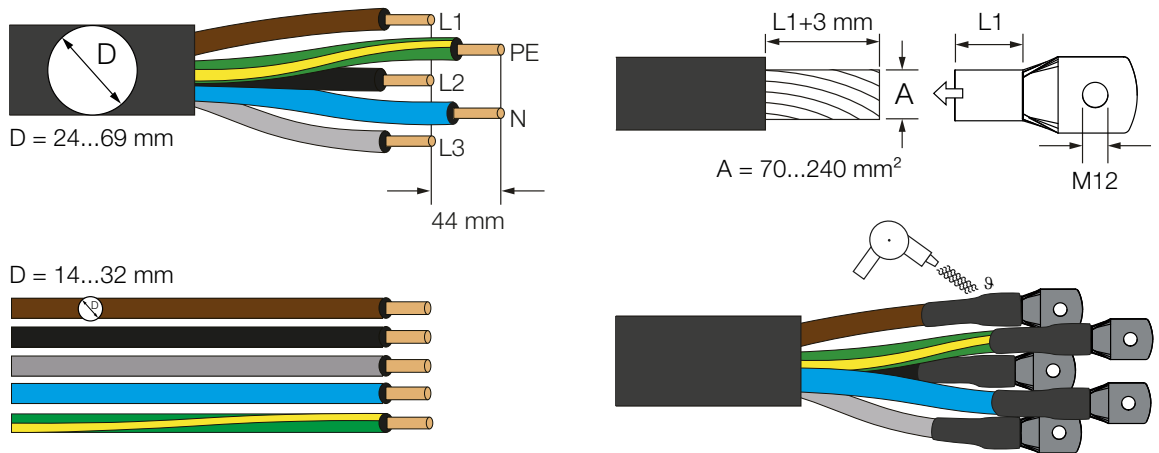

5. Connect the mains cable to the AC terminal according to the labelling.



**IMPORTANT INFORMATION**

Make sure that the phases of the AC terminal and in the mains supply match.

The 4-wire AC connection (3L/PE without N) is only possible in symmetrical networks.

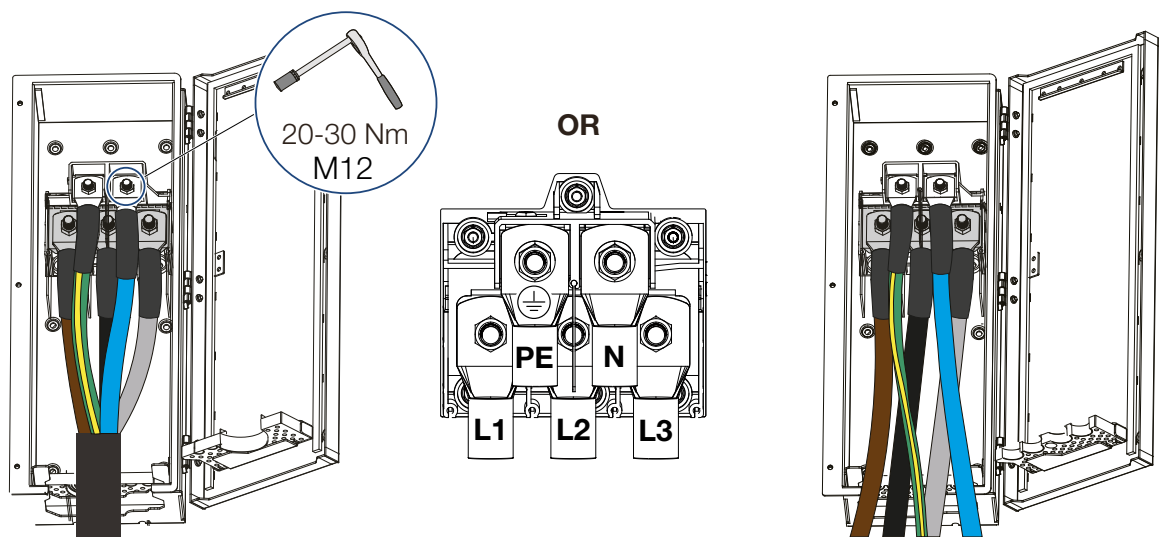

6. Close the AC terminal compartment and screw the cover tight.  
Tightening torque: 3–4 Nm.

7. In countries in which a second PE connection is required, connect this at the marked place on the housing (outside).



1

2

3

4

5

6

7

8

9

10

11

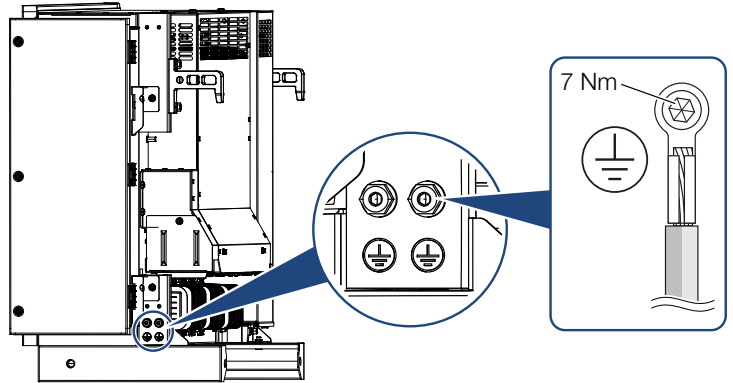
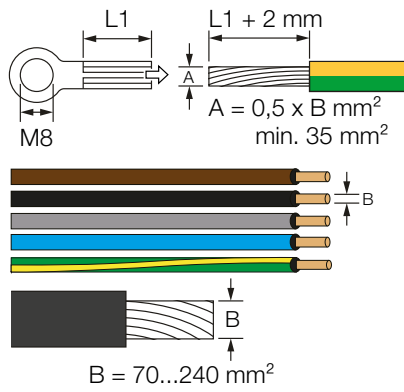

✓ Mains cable connected





1

2

3

4

5

6

7

8

9

10

11

## 4.5 Overview of communication connections

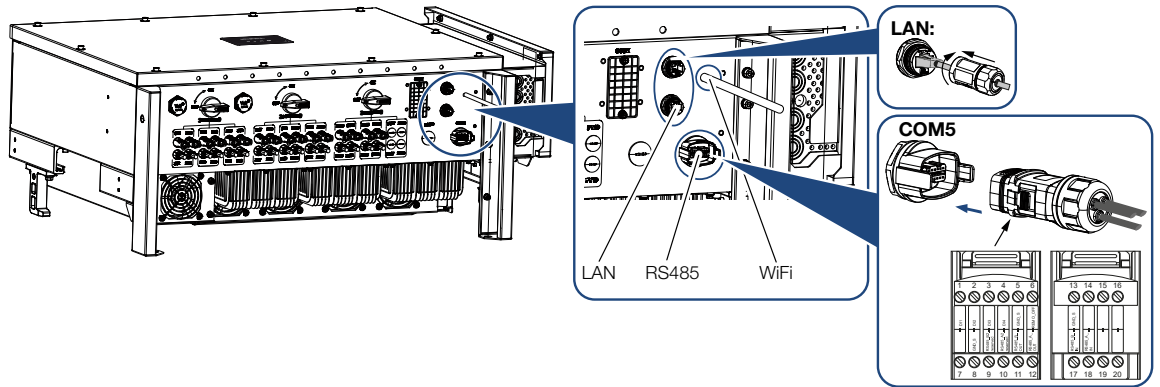

Designation	Pin	Explanation
RJ45 LAN terminal	--	LAN connection 1
	--	LAN connection 2
COM5 communication interface	1	D 1 (ripple control receiver)
	2	D 2 (ripple control receiver)
	3	D 3 (ripple control receiver)
	4	D 4 (ripple control receiver)
	5	GND_S (ripple control receiver)
	6	Remote: Central system protection
	8	GND_S (central system protection)
	9	RS485_B2 (reserved)
	10	RS485_B2 (reserved)
	11	RS485_B_OUT
	12	RS485_A_OUT
	13	GND_S (RS485)
	14	---
	15	---
	16	---
	17	RS485_B_IN
	18	RS485_A_IN
	19	---
20	---	



1

2

3

4

5

6

7

8

9

10

11

## 4.6 Mounting WiFi antenna

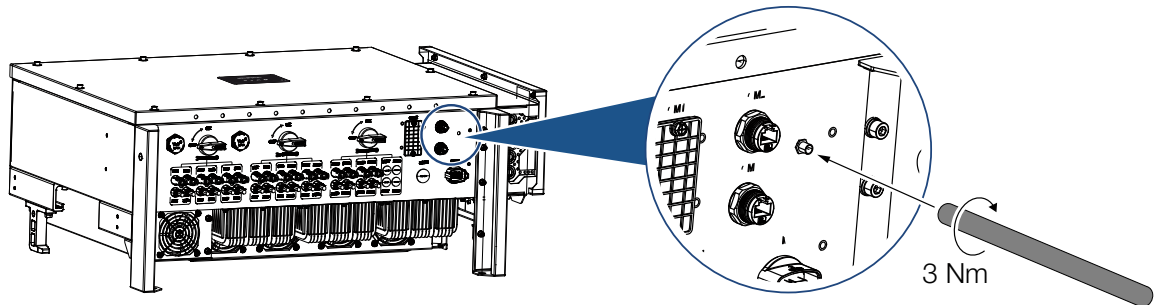

1. Remove protective cap from connection thread on inverter.
  2. Screw the supplied WiFi antenna onto the stud bolt.  
Tightening torque: 3 Nm
- ✓ WiFi antenna mounted.

## 4.7 Types of communication

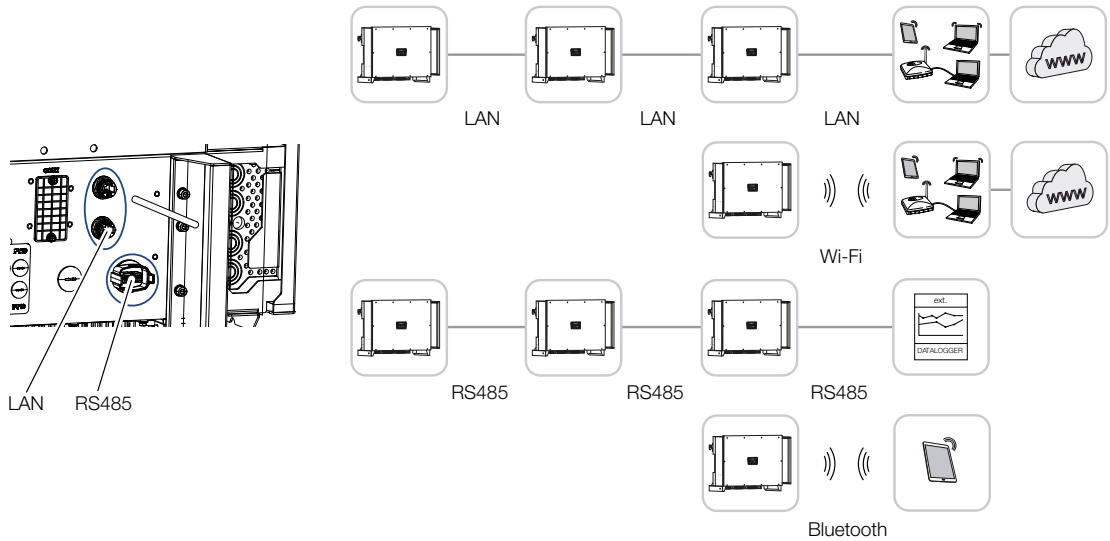

The inverter has interfaces for LAN, RS485 Modbus and WiFi. There are therefore various possibilities for networking one or more inverters with each other and controlling them.

You can also combine different types of connections with each other. In a solar power plant, for example, it may be useful to network several inverters in the field in a wired manner (LAN/Ethernet or RS485), and to produce the connection to the local communication hub wirelessly via a radio link.

The inverter can be accessed directly via the local Bluetooth interface. The interface is used for initial commissioning or for direct configuration on site.

### LAN / Ethernet

**i INFO**

Connecting the Ethernet cable to a router integrates the inverter into your own network and the inverter can then be contacted by all computers incorporated in the same network.

When networking via Ethernet, the inverter can be connected to the local network or the Internet. To do this, use one of the RJ45 connections in the connection panel.

Computers, routers, switches and/or hubs or other devices can be connected to the network.

**☑ Communication via LAN, Page 45**



## RS485 Modbus

Modbus is an industry standard for networking industrial measurement and control systems. A data logger or energy meter, for example, can be connected via this connection to control the connected inverters.

**☑ Communication via RS485, Page 46**

## WLAN / WiFi



### INFO

At a later date, there are also plans for a connection from inverter to inverter.

Via WiFi, one or more inverters can be integrated into the local WLAN network, e.g. via a router or hub.

**☑ Communication via WiFi, Page 48**

## Bluetooth

The Bluetooth interface is used primarily to configure the inverter on site or for initial commissioning.

This is done by using the app and connecting the inverter via Bluetooth.

**☑ Communication via Bluetooth, Page 49**

## 4.8 Communication via LAN

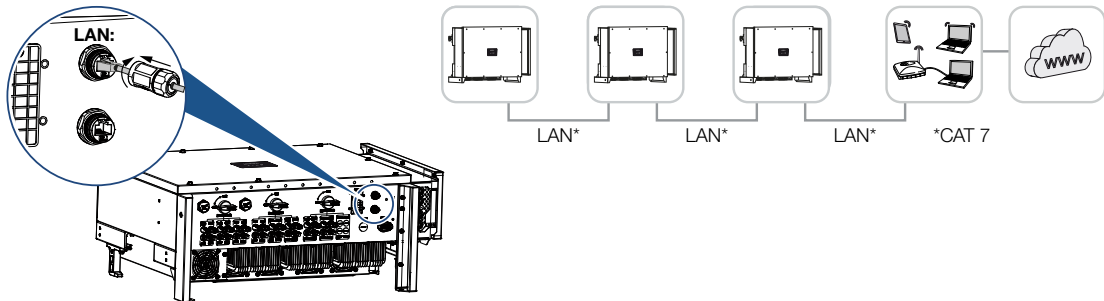

### Connecting inverter to LAN/Ethernet cable

#### **i** INFO

Use an Ethernet cable of category 7 (Cat 7, FTP) with a maximum length of 100 m as a network cable (Ethernet 10BaseT, 10/100 MBit/s).

1. Guide the Ethernet cable through the LAN cover provided.
2. Connect Ethernet cable to one of the LAN sockets.  
The second LAN socket is used to continue the network connection to further inverters.
3. Tighten LAN cover to the specified tightening torque.  
Tightening torque: 3 Nm.
4. Connect LAN/Ethernet cable to the computer or router.

#### **i** INFO

After commissioning, the settings for the Ethernet connection can still be configured in the app.

This includes, for example, the setting for IP mode, in which acquisition of an automatic IP address can be set.

5. The inverter is set as **Master LAN** or slave using the app on each inverter. To do this, go to **Settings > Communication settings > Master/Slave settings > Master/Slave settings** and then select **Master LAN** or **Slave**. The master forwards data to the slave inverters. This can be, for example, a feed-in limitation.
- ✓ LAN cable connected

## 4.9 Communication via RS485

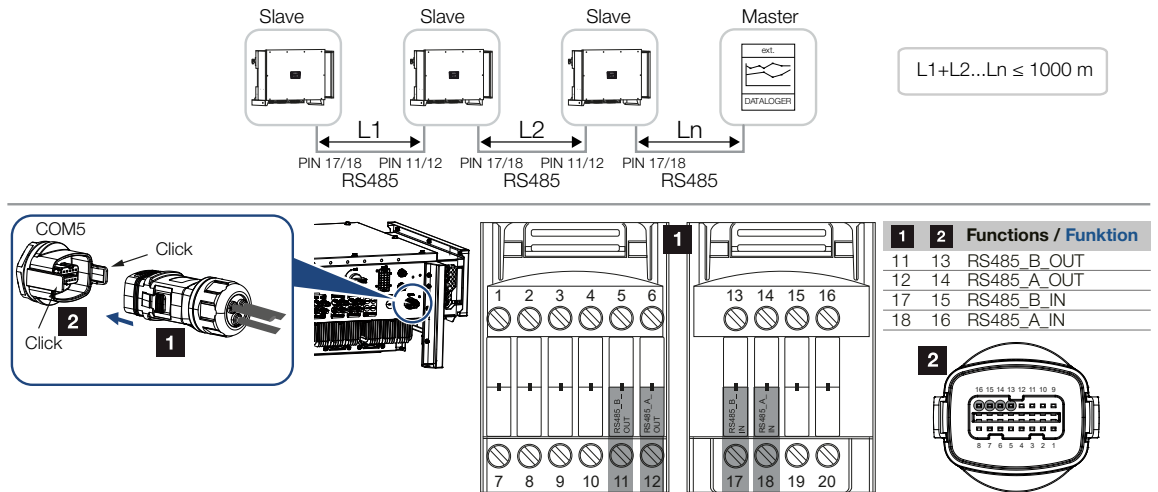

### Connecting the RS485 connection

1. De-energise the inverter. Switching off the inverter

#### **i** INFO

Requirements of communication cable:

- wire cross-section from 0.34 to 1.5 mm<sup>2</sup> (rigid) or 0.34 to 1.0 mm<sup>2</sup> (flexible)
- bus length max. 1000
- length of stripped insulation approx. 7.5 mm

2. Guide the RS485 cable through the communication plug and seal provided.

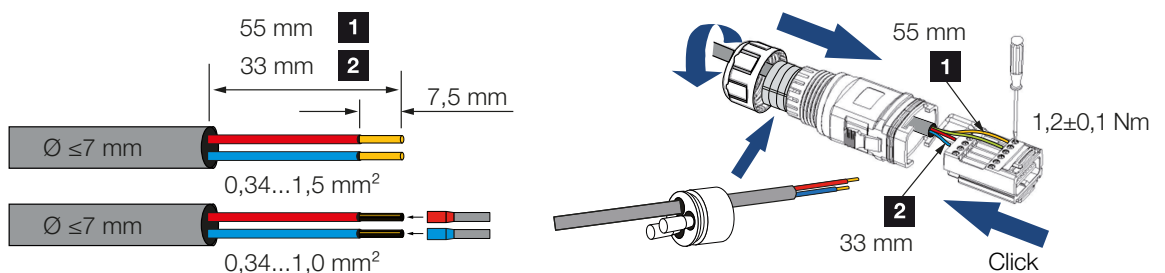

3. Fit RS485 cable on plug.  
RS485 out is used to continue the network connection to further inverters.
4. Assemble plug and tighten union nut to the prescribed tightening torque.  
Tightening torque: 3 Nm.
5. Connect plug to interface in COM5 connection panel.  
Connect RS485 cable to external device (e.g. data logger).

**INFO**

After commissioning, the settings for the RS485 connection still have to be configured in the app.

This includes, for example, setting the transmission speed.

6. The inverter is set as **Master RS485** or slave using the app on each inverter. To do this, go to **Settings > Communication settings > Master/Slave settings > Master/Slave settings** and then select **Master RS485** or **Slave**. The master forwards data to the slave inverters. This can be, for example, a feed-in limitation.
  7. The RS485 termination of the last inverter must be set to **ON** in the app. This can be done under **Settings > Communication settings > RS485 Settings > Terminal resistor**.
- ✓ RS485 cable connected.

## 4.10 Communication via WiFi

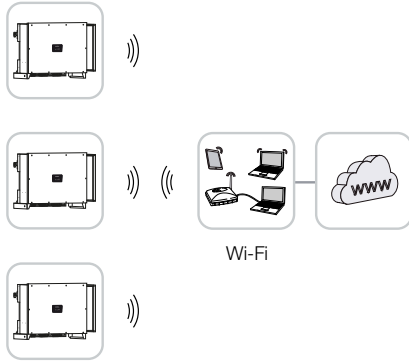

### Connecting inverters via WiFi

1. The WiFi settings must be configured for each inverter in the app.

#### INFO

If you have forgotten the WLAN password, it can be reset via the app. The default password is: **12345678**.

2. To do this, go to the following menu item and configure the settings:  
**Settings > Communication settings > WLAN settings > Select WLAN connection**
- ✓ Inverter connected via WiFi.





1

2

3

4

5

6

7

8

9

10

11

## 4.11 Communication via Bluetooth

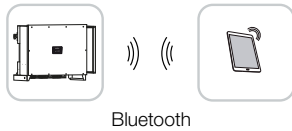

### Connecting inverter via Bluetooth

1. Enable the Bluetooth function on your tablet or smartphone.
  2. Switch on the inverter.
  3. Launch the app.
  4. Select Bluetooth as the connection in the app.  
→ The list of inverters appears.
  5. If the inverter is not yet included in the list, go to **Scan for new device** and scan the serial number on the type plate
- ✓ When the app displays the message **Connect**, the inverter is connected.

## 4.12 Connecting the KOSTAL Smart Energy Meter

Connecting a allows generation values and consumption values to be recorded or the output power of the inverter into the public grid to be controlled. In addition, the can send data to the . To do this, the must be set up in addition to the in the same system in the .

The energy meter is installed in the meter cabinet or in the main distribution board. Please also refer to the operating documentation of the .

### ! IMPORTANT INFORMATION

Only energy meters that have been approved for this inverter may be used.

You will find an up-to-date list of the approved energy meters on our website in the download area for the product.

The following energy meters are currently approved:

- 

The can be connected to in two different ways. The connection method must then be set via the app.

- [Communication connection for KOSTAL Smart Energy Meter via LAN, Page 50](#)
- [Communication connection for KOSTAL Smart Energy Meter via RS485, Page 53](#)

### Communication connection for KOSTAL Smart Energy Meter via LAN

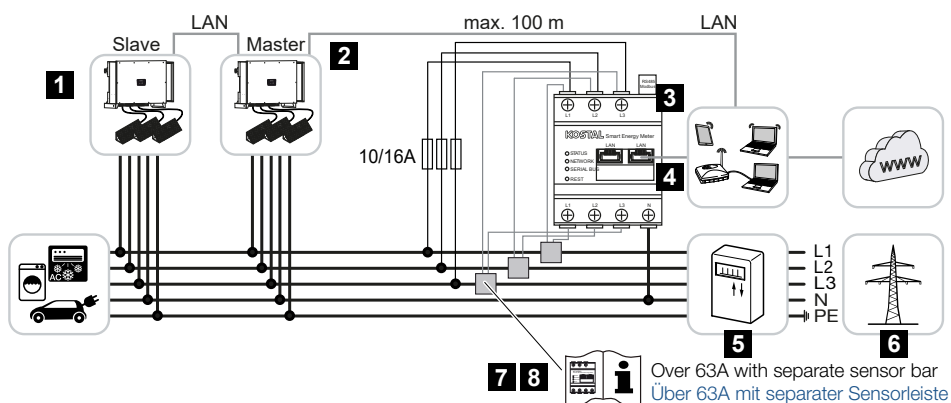

- 1 Inverter
- 2 LAN interface to inverter
- 3 KOSTAL Smart Energy Meter
- 4 LAN interface for KOSTAL Smart Energy Meter
- 5 Feed meter



1

2

3

4

5

6

7

8

9

10

11

- 6 Public grid
- 7 Read the operating manual for the KOSTAL Smart Energy Meter.
- 8 Use a current transformer for currents above 63 A

## Connecting the KOSTAL Smart Energy Meter

1. De-energise the mains cable.



### DANGER

#### Risk of death due to electrical shock and discharge!

De-energise all devices and secure them against being switched on again.

2. Install the as shown in the illustrations at the grid connection point in the house grid.



### INFO

Use an Ethernet cable of category 7 (Cat 7, FTP) with a maximum length of 100 m as a network cable (Ethernet 10BaseT, 10/100 MBit/s).

3. Guide the Ethernet cable through the LAN cover provided.
4. Connect Ethernet cable to one of the LAN sockets.  
The second LAN socket is used to continue the network connection to further inverters.

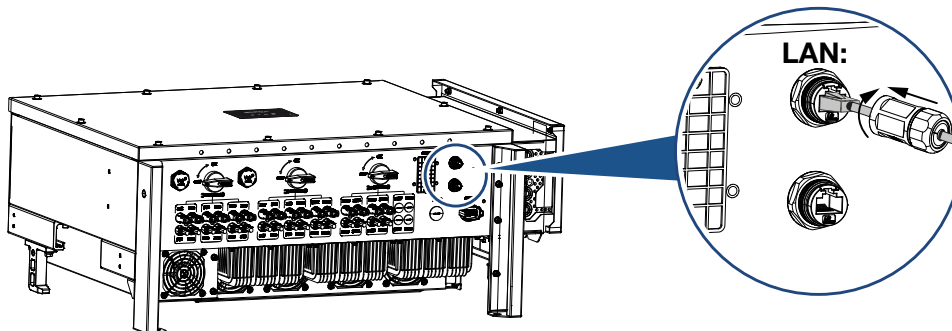

5. Tighten LAN cover to the specified tightening torque.  
Tightening torque: 3 Nm.
6. Connect the other end of the Ethernet cable to the router.
7. Establish a LAN connection from the to the router.
8. In this variant, the works as a slave and sends data to the inverter.
9. In the , set **Modbus settings > Modbus TCP > Slave (Enable TCP Slave) to ON.**
10. To make the home consumption visible in the , in the set **Inverter > Solar portal > Activate solar portal to ON.**



## After commissioning

After commissioning, the following settings still have to be configured in the app.

1. The usage and installation position of the (KSEM) has to be set in the app on the **master** inverter.  
This can be set under **Settings > Inverter settings > Power adaptation/controls > Energy management > External sensor > KSEM** and **Settings > Inverter settings > Power adaptation/controls > Energy management > Sensor position > On grid** (default value).
2. The IP address of the can be set in the app under **Settings > Power adaptation/controls > Energy management > IP address of energy meter**.
3. A power limitation of the grid feed-in (e.g. to 70%) must be entered in watts on the **Master** inverter.  
This can be set under **Settings > Inverter settings > Power adaptation/controls > Energy management > Limitation of the active power to [W]**.



### INFO

If power limitation is carried out in combination with the , power limitation via a ripple control receiver (RCR) is not possible and must be deactivated.

4. The is connected to the **master** inverter. If not already done, configure this inverter as a **master LAN**.  
This can be selected in the app under **Settings > Communication settings > Master/Slave settings > Master LAN**.
  5. All other inverters connected to the master inverter must be configured as **slave**. The following default settings should be checked for all slave inverters:
    - Master/slave settings:** Slave
    - External sensor:** deactivated
    - Sensor position:** Grid connection point
    - Ripple Control Receiver Enable:** OFF
- ✓ Inverter connected to the .



## Communication connection for KOSTAL Smart Energy Meter via RS485

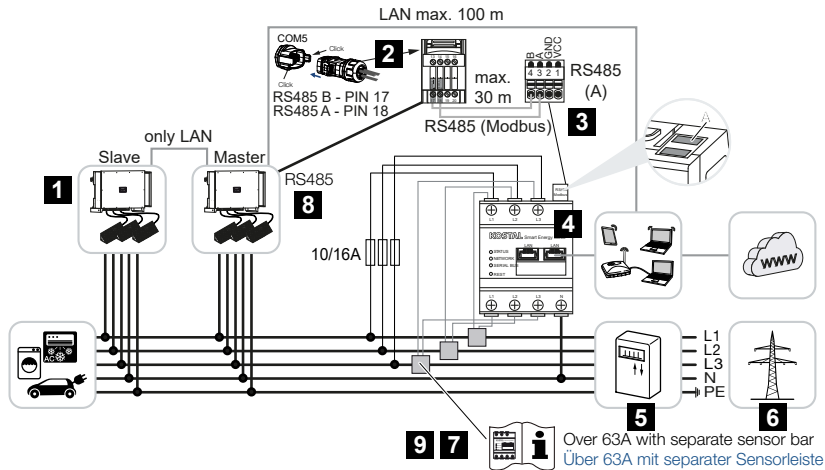

- 1 Inverter
- 2 RS485 interface for inverter
- 3 RS485 interface for KOSTAL Smart Energy Meter
- 4 KOSTAL Smart Energy Meter
- 5 Feed meter
- 6 Public grid
- 7 Read the operating manual for the KOSTAL Smart Energy Meter
- 8 Set RS485 termination in KOSTAL PIKO CI app to ON
- 9 Use a current transformer for currents above 63 A. Read the operating manual for the KOSTAL Smart Energy Meter

## Connecting the KOSTAL Smart Energy Meter

1. De-energise the mains cable.



**DANGER**

**Risk of death due to electrical shock and discharge!**

De-energise all devices and secure them against being switched on again.

2. Install the as shown in the illustrations at the grid connection point in the house grid.
3. Correctly route the communication cable from the inverter to the control cabinet and connect to the following the manufacturer's wiring diagram.

**i** INFO

Requirements of communication cable:

- wire cross-section from 0.34 to 1.5 mm<sup>2</sup> (rigid) or 0.34 to 1.0 mm<sup>2</sup> (flexible)
- bus length max. 1000
- length of stripped insulation approx. 7.5 mm

4. De-energise the inverter. Switching off the inverter
5. Guide the RS485 cable through the communication plug and seal provided.

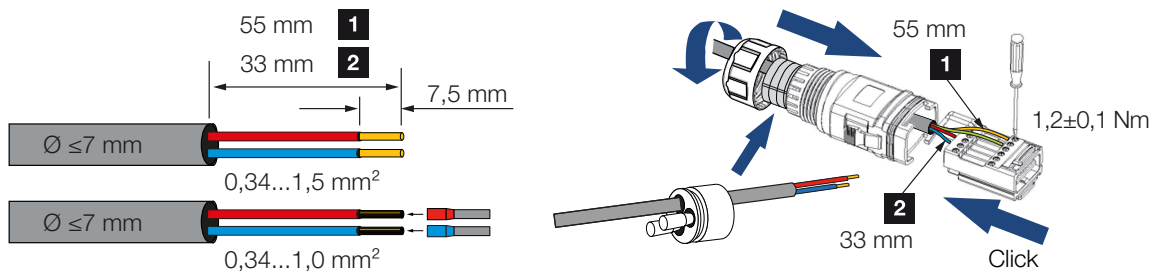

6. Fit RS485 cable on inverter plug.

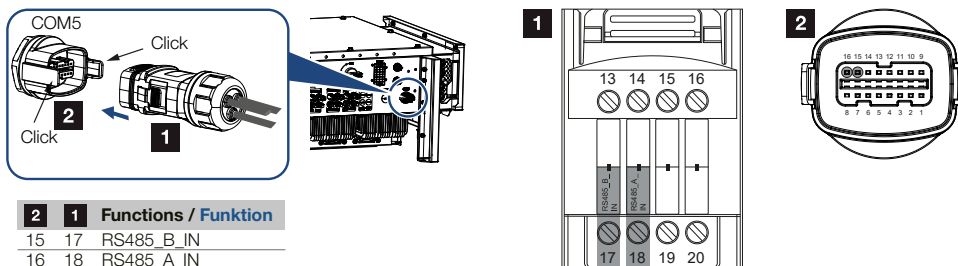

7. Assemble plug and tighten union nut to the prescribed tightening torque. Tightening torque: 3 Nm.
8. Connecting plug to interface in COM5 connection panel
9. Establish a LAN connection from the and the inverter to the Internet.
10. In this variant, the works as a slave and sends data to the inverter.
11. In the , select the for the RS485 A interface. Please refer to the operating manual of the .

**After commissioning**

**i** INFO

After commissioning, the settings for the RS485 connection still have to be configured in the app.

This includes, for example, setting the transmission speed.



1

2

3

4

5

6

7

8

9

10

11

1. The usage and installation position of the (KSEM) has to be set in the app on the **master** inverter.  
This can be set under **Settings > Inverter settings > Power adaptation/controls > Energy management > External sensor > KSEM** and **Settings > Inverter settings > Power adaptation/controls > Energy management > Sensor position > On grid** (default value).
2. A power limitation of the grid feed-in (e.g. to 70%) must be entered in watts on the **Master** inverter.  
This can be set under **Settings > Inverter settings > Power adaptation/controls > Energy management > Limitation of the active power to [W]**.

**INFO**

If power limitation is carried out in combination with the , power limitation via a ripple control receiver (RCR) is not possible and must be deactivated.

3. The inverter to which the has been connected must be configured as the **master**.  
This can be selected under **Settings > Communication settings > Master/Slave settings > Master RS485**.
  4. On the **master** inverter, which is connected to the RS485 communication cable, set RS485 termination in the app to **ON**.  
This can be done under **Settings > Communication settings > RS485 settings > Terminal resistor**.
  5. All other inverters connected to the master inverter via LAN must be configured as **slave**. The following default settings should be checked for all slave inverters:  
**Master/slave settings:** Slave  
**External sensor:** deactivated  
**Sensor position:** Grid connection point  
**Ripple Control Receiver Enable:** OFF
- ✓ Inverter connected to the .

## 4.13 Connecting central grid and system protection

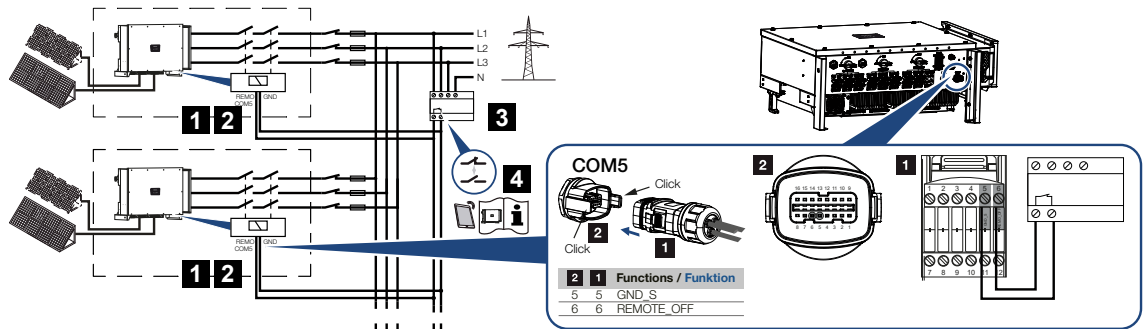

- 1 COM5 plug
- 2 Inverter's COM5 connection
- 3 Grid and system protection - Switch closed: Feed-in, Switch open: Feed-in prevented
- 4 Activation of grid and system protection via KOSTAL PIKO CI app

Central grid and system protection is required in some countries. This monitors the voltage and frequency in the grid and in the event of a fault, shuts down the photovoltaic systems by means of a circuit breaker.

If your energy supplier requires central grid and system protection for your system, install an external monitoring device, which switches off the inverter via a normally open or normally closed contact. An additional circuit breaker is not necessary because of the internal switches in the inverter.

### Connection

1. De-energise the mains cable.



**DANGER**

#### Risk of death due to electrical shock and discharge!

De-energise all devices and secure them against being switched on again.

2. Mount the monitoring device in the control cabinet or power distributor.
3. Correctly route the communication cable from the inverter to the control cabinet and connect following wiring diagram provided by manufacturer.



**i** INFO

Requirements of communication cable:

- wire cross-section from 0.34 to 1.5 mm<sup>2</sup> (rigid) or 0.34 to 1.0 mm<sup>2</sup> (flexible)
- bus length max. 1000
- length of stripped insulation approx. 7.5 mm

4. Guide the communication cable through the communication plug and seal provided.

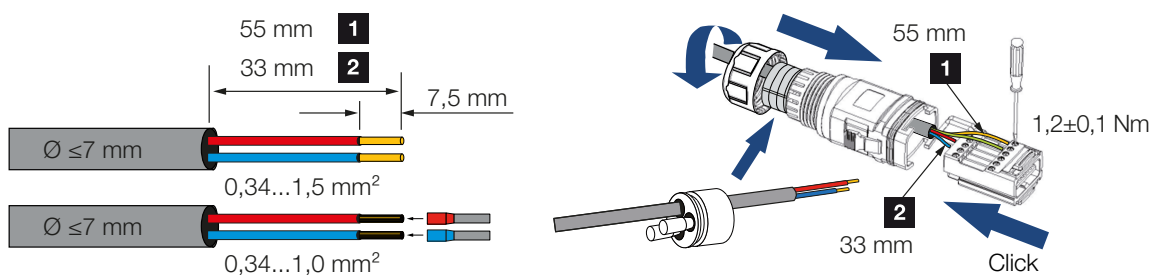

5. Fit the communication cable on the inverter plug.

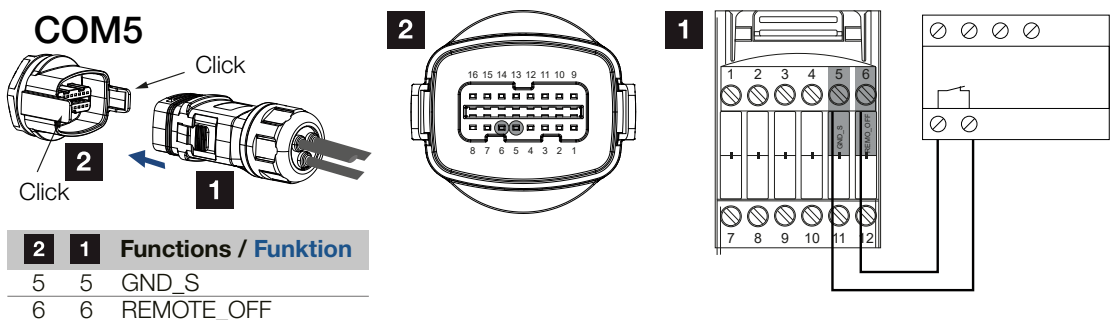

6. Assemble plug and tighten union nut to the prescribed tightening torque.  
Tightening torque: 3 Nm.

7. Connect plug to interface in COM5 connection panel.

**After commissioning**

1. After commissioning, the function must be activated in each inverter via the app.  
This can be activated under **Settings > Basic settings > External shutdown > ON**.
- ✓ Inverter set up for grid and system protection function.



## 4.14 Connecting ripple control receiver

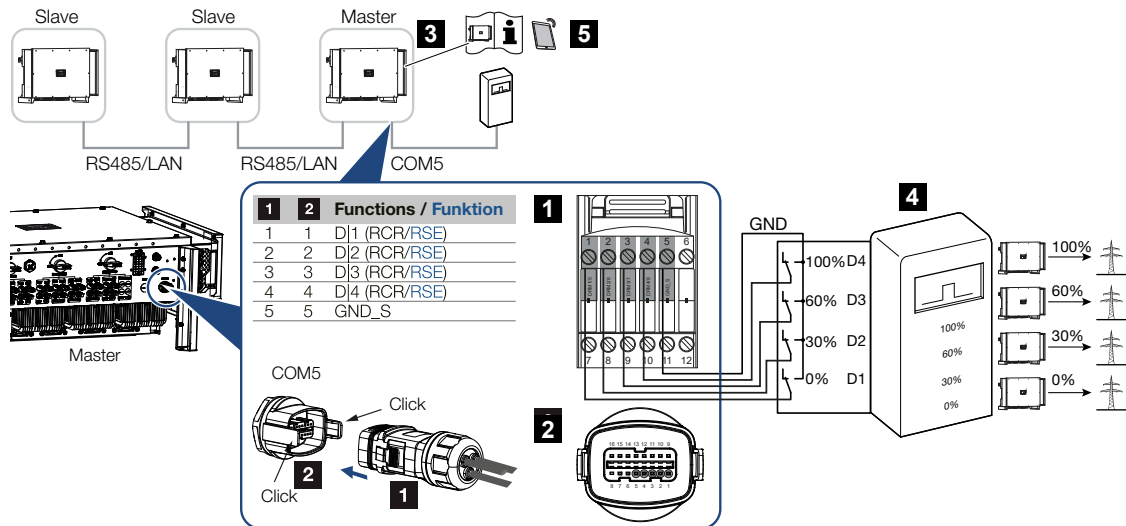

- 1 Plug for COM5 communication interface
- 2 Socket for COM5 communication interface
- 3 Inverter to which the ripple control receiver is connected
- 4 Ripple control receiver
- 5 Activate the ripple control receiver in the KOSTAL PIKO CI app

Several energy supply companies offer the owners of PV systems the option of regulating their system with variable active power control and thus increasing the feed-in into the public grid to up to 100%.

### **i** INFO

In some applications, the digital may be regarded as a cost-effective alternative to the ripple control receiver. Here the feed-in may well be limited by the energy supply company, but the inverter controls the flow of energy (self-consumption in house grid and feed-in to the public grid) in such a way that the self-produced energy is not lost or loss is kept to an absolute minimum.

Ask your energy supply company or installer what application rule applies to you or whether there is an alternative (e.g. smart meter) better suited to you.

If a ripple control receiver is already connected to another KOSTAL inverter in your home network, you can use the control signals of this ripple control receiver.

### Connection

1. De-energise the mains cable.

**DANGER**

**Risk of death due to electrical shock and discharge!**

De-energise all devices and secure them against being switched on again.

2. Fit ripple control receiver in control cabinet or power distributor.
3. Correctly route the communication cable from the inverter to the control cabinet and connect following wiring diagram provided by manufacturer.

**INFO**

Requirements of communication cable:

- wire cross-section from 0.34 to 1.5 mm<sup>2</sup> (rigid) or 0.34 to 1.0 mm<sup>2</sup> (flexible)
- bus length max. 1000
- length of stripped insulation approx. 7.5 mm

4. Guide the communication cable through the communication plug and seal provided.

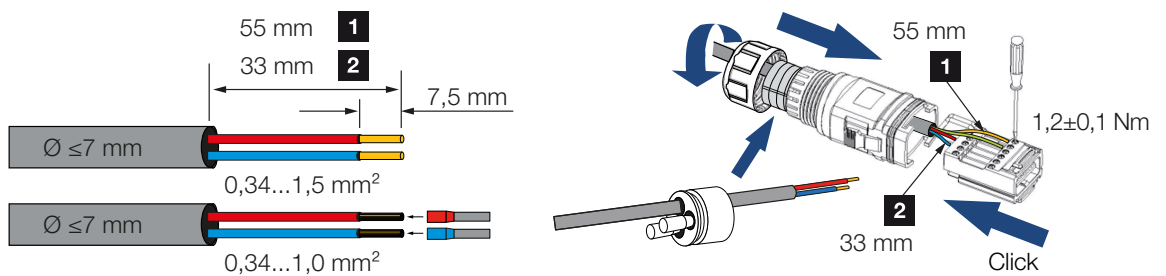

5. Fit the communication cable on the inverter plug.

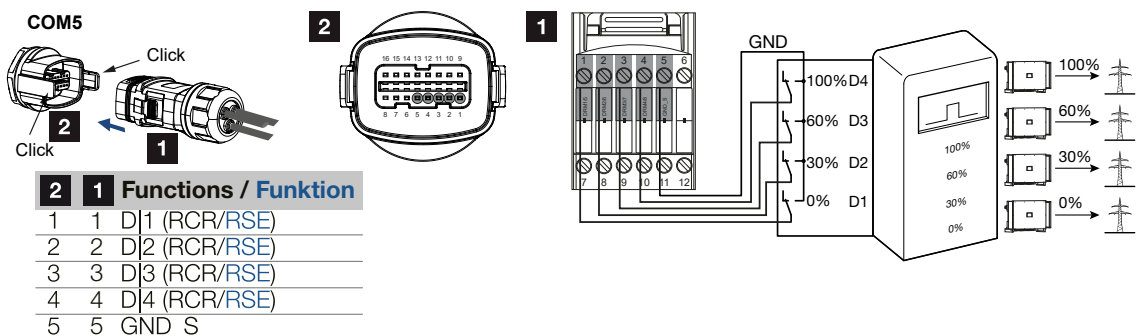

6. Assemble plug and tighten union nut to the prescribed tightening torque. Tightening torque: 3 Nm.
7. Connect plug to interface in COM5 connection panel.



## After commissioning

1. Open the app and connect to the inverter to which the ripple control receiver is connected.
  2. Activate the ripple control receiver in the app under **Settings > Inverter settings > Power adaptation/controls > Ripple control receiver (RCR) > Ripple Control Receiver Enable > ON**.
  3. Set switching values for the ripple control receiver under **Settings > Inverter settings > Power adaptation/controls > Ripple control receiver (RCR) > RCR active power / RCR reactive power / RCR power factor**.
  4. Set the communication (LAN or RS485) on the master inverter to the other inverters by going to **Settings > Communication settings > Master/Slave settings > Master/Slave settings > Master**.
- ✓ The ripple control receiver is connected.

## 4.15 Connecting PV modules

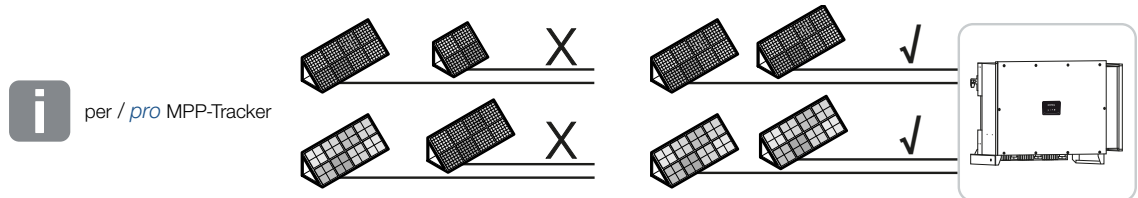

### Connectable solar modules

When selecting the PV modules to be connected to series inverters, note the following:

- Only connect PV modules according to IEC 61730 Class A.
- Do not ground the PV cables.
- Use suitable cables with the largest possible cross-section for connecting the PV modules!



### IMPORTANT INFORMATION

Use flexible and tin-plated cables with double insulation according to EN50618.

We recommend a cross-section of 6mm<sup>2</sup>. Please observe the specifications of the plug manufacturer and the technical data for the inverter.

- Per MPP tracker:
  - Only connect PV modules of the same type to an MPP tracker, i.e.:
  - same manufacturer,
  - same type,
  - same performance,
  - same size.

Different module types, sizes and connected loads and also a different number of PV modules can be connected to different MPP trackers.

Make sure that the maximum input current ( $I_{DCmax}$ ) per MPPT and the maximum DC current per DC plug ( $I_{Stringmax}$ ) are not exceeded in the process.

📄 **Technical data, Page 127**



## Solar module connections



### DANGER

#### Risk of death due to electrical shock and discharge!

The PV generators/cables may be live as soon as they are exposed to light.



### WARNING

#### Serious burns due to arcs on the DC side!

During operation, dangerous arcs can occur when pulling or plugging the DC connections.

Before connecting the DC connectors, de-energise the DC side. DC switches must be in the OFF position.



### WARNING

#### Risk of fire due to improper installation!

Incorrectly fitted plugs and sockets may heat up and cause a fire.

During installation, be sure to follow the manufacturer's requirements and manual. Properly mount plugs and sockets.



### POSSIBLE DAMAGE

#### Risk of damage to the inverter due to PV modules connected with the wrong polarity

PV modules connected with the wrong polarity may cause thermal damage to the inverter.

- Measure the DC cables of the PV modules and connect to inverter with the correct polarity.
- Comply with the maximum input current per string for the inverter as stated in the technical data.
- The maximum input current must not be exceeded, even when using Y or T plugs.

Please note the following points before connecting the PV modules:

- Our planning tool should be used to optimally configure the solar modules and achieve the highest possible yields.
- Check the planning and the wiring of the modules for plausibility.



1

2

3

4

5

6

7

8

9

10

11

- Measure and record the DC idling voltage and polarity of the PV modules. The idling voltage of the PV modules must be in the voltage range between  $U_{DCstart}$  and  $U_{DCmax}$ .

$U_{DCstart}$	$U_{DCmax}$
250	1100

- Make sure that the maximum short-circuit current of the PV modules is less than the permitted value.
- Make sure that the PV modules are not short-circuited.
- Make sure that the inverter is closed when the PV modules are connected.
- Make sure that when connecting several inverters there is no cross-connection of the PV modules.

Failure to observe these requirements will render any warranty, guarantee or other liability offered by the manufacturer null and void.

## Preparing PV connector

The inverter uses DC plug connectors of the Helios H4 type from Amphenol.

During installation, use the DC plug connectors supplied with the inverter. Using incompatible positive and negative metal contacts and DC plug connectors may have serious consequences. Any resultant damage to the device is not covered by warranty.

- During installation, it is essential that the current specifications of the manufacturer are observed.  
Information about the Amphenol installation specification is available from:  
[www.amphenol.com](http://www.amphenol.com)
- Only use installation tools from the manufacturer.
- When mounting the sockets and plugs, ensure that the solar modules have the correct polarity. PV modules connected with the wrong polarity may cause thermal damage to the inverter.

## Installing PV plug connectors



### DANGER

#### Risk of death due to electrical shock and discharge!

Disconnect the DC cables by interrupting the connections to the PV modules.

If it is not possible to disconnect the DC cables, observe the rules for working under voltage.

Use personal protective equipment, hard hat, visor or goggles, protective suit, insulating gloves.

Use an insulating protective mat as an underlay.

Only use insulated tools.

1. Strip approx. 9 mm of insulation off the solar cable.

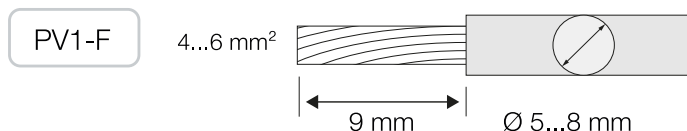

2. Insert stripped wire end into crimped neck of contact.

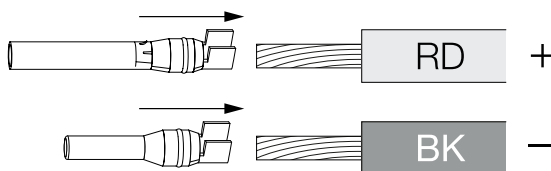

3. Crimp the contact with a suitable crimping tool.

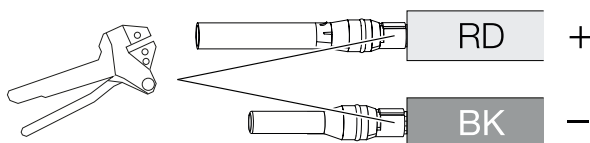

4. Insert contact into plug connector until the contact clicks into place tangibly and audibly.



### INFO

Once snapped into the housing, the contact cannot be removed from the plug connector.





1

2

3

4

5

6

7

8

9

10

11

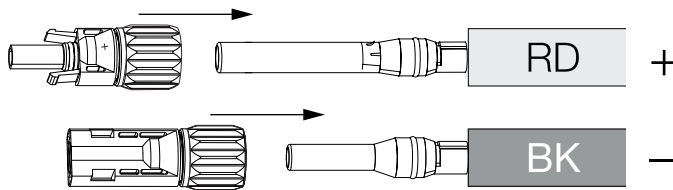

5. Tighten nut on plug connector (3 Nm).

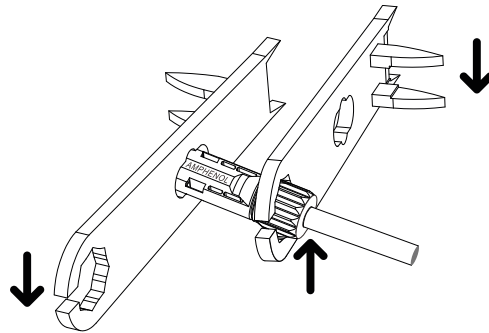

✓ PV connector installed

## Selecting PV inputs

If the inverter's DC inputs are not fully occupied, distribute the input assignment in accordance with the following tables: Make sure that the maximum input current ( $I_{DCmax}$ ) per MPPT and the maximum DC current per DC input ( $I_{stringmax}$ ) are not exceeded in the process:

### **i** INFO

Only connect PV modules of the same type to an MPP tracker, i.e.:

- same manufacturer,
- same type,
- same performance,
- same size.

### Maximum input current

$U_{DCstart}$	$U_{DCmax}$	$I_{DCmax}$ per MPP tracker	$I_{Stringmax}$
$\leq 250 \text{ V}$	$\leq 1100 \text{ V}$	MPPT 1: 40 A MPPT 2: 40 A MPPT 3: 40 A MPPT 4: 32 A MPPT 5: 32 A MPPT 6: 32 A MPPT 7: 32 A MPPT 8: 32 A	DC 1-2: $\leq 20 \text{ A}$ DC 3-4: $\leq 20 \text{ A}$ DC 5-6: $\leq 20 \text{ A}$ DC 7-8: $\leq 20 \text{ A}^*$ DC 9-10: $\leq 20 \text{ A}^*$ DC 11-12: $\leq 20 \text{ A}^*$ DC 13-14: $\leq 20 \text{ A}^*$ DC 15-16: $\leq 20 \text{ A}^*$

\* With 2 DC strings connected,  $I_{Stringmax} \leq 16 \text{ A}$ .

### DC connection assignment 100

Connected PV strings	MPP trackers							
	1	2	3	4*	5*	6*	7*	8*
Used DC input								
1	1							
2	1	3						
3	1	3	5					
4	1	3	5	7				
5	1	3	5	7	9			
6	1	3	5	7	9	11		
7	1	3	5	7	9	11	13	
8	1	3	5	7	9	11	13	15
9	1, 2	3	5	7	9	11	13	15
10	1, 2	3, 4	5	7	9	11	13	15
11	1, 2	3, 4	5, 6	7	9	11	13	15
12	1, 2	3, 4	5, 6	7, 8	9	11	13	15
13	1, 2	3, 4	5, 6	7, 8	9, 10	11	13	15
14	1, 2	3, 4	5, 6	7, 8	9, 10	11, 12	13	15
15	1, 2	3, 4	5, 6	7, 8	9, 10	11, 12	13, 14	15
16	1, 2	3, 4	5, 6	7, 8	9, 10	11, 12	13, 14	15, 16

(\*) With 2 DC strings connected,  $I_{Stringmax} \leq 16 \text{ A}$ .



1

2

3

4

5

6

7

8

9

10

11

## Connecting PV modules to the inverter

The DC cables of the solar modules must not be connected to the inverter under load.



### DANGER

#### Risk of death due to electrical shock and discharge!

Switch off the inverter on both the AC and DC sides.

1. Unlock the AC connection of the inverter by switching off the line circuit breaker.

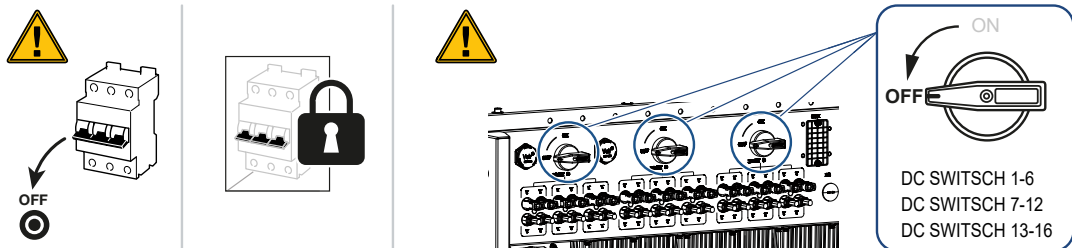

2. Turn the DC switch on the inverter to “OFF”.
3. Measure the DC cables of the PV modules before connecting them to the inverter with the correct polarity. PV modules connected with the wrong polarity may cause thermal damage to the inverter.  
Exceeding the maximum input current per string may result in damage to the inverter. Therefore, the maximum input current per string for the inverter as stated in the technical data must not be exceeded.

$U_{DCstart}$	$U_{DCmax}$
250	1100



### INFO

Observe national regulations! In France, in particular, the inverter and the supply lines must be labelled, for example.

The installer is responsible for obtaining and affixing the prescribed markings.

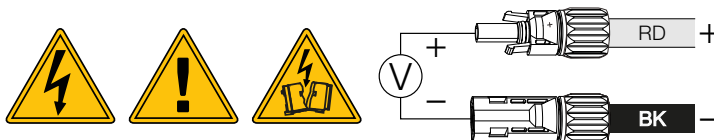

1. Remove protective caps from input terminals.



### INFO

Keep the protective caps of the PV connections for future use.



1

2

3

4

5

6

7

8

9

10

11

2. Fit plug connectors of the individual PV strings into the DC inputs PV+ and PV- in pairs until they engage tangibly and audibly.

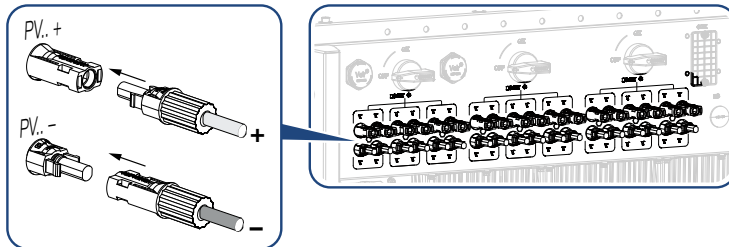

- ✓ The PV modules are connected.

## 4.16 Initial commissioning

### Installing KOSTAL PIKO CI app

1. Download the app from the Apple App Store or Google Play Store onto your tablet or smartphone.



### Connecting inverter to app

For the inverter's initial commissioning, the inverter is connected to the smartphone via Bluetooth.

1. Switch on the inverter.
2. Turn on the Bluetooth function on your tablet or smartphone.
3. Launch the app.
4. Permit access to locations, camera and data storage on the smartphone.
5. Select the Bluetooth connection in the app to connect with the inverter.

DOWNLOAD UPDATE FILES



AP



Bluetooth



#### INFO

If there are a lot of metal parts in the installation environment of the inverter – e.g. support frames, connecting cables, enclosures – the range of the radio connection may be impaired. Change position if you experience connection problems.

- A list of inverters is displayed (devices are displayed in the following form: **PIKO CI 100 <the last 4 numbers of the serial number>**).  
If the inverter is not included, go to **Scan new devices**.
- 6. Scan the serial number on the type plate. If you are not able to do this, the serial number can be entered manually by going to **Enter SN**.
- The app displays the discovered inverters.



1

2

3

4

5

6

7

8

9

10

11

7. Select the inverter you want to start up.

✓ When the app displays the message **Connect**, the inverter is connected.

## Procedure for initial commissioning

### INFO

The installation process may vary depending upon the software version of the inverter.

Information about the menus:  **KOSTAL PIKO CI app - menu structure, Page 85**

1. In the app, select the **Settings** page.

→ On the **Settings** page, the app shows you various menus where you can configure settings.

2. In order to have access to all relevant settings, go to the **User Management** menu item and then select **Change user**.

3. Select **Login** as **installer**.

4. Enter the password **superadmin** and select **Login**.

### INFO

The default password for the installer/administrator is **superadmin**.

With this user, a variety of settings can be configured vis-à-vis the system operator, such as network settings, power limitations or grid guidelines.

This password should be changed after the initial commissioning. If you forget your password, it can be reset via the service.

5. Configure the settings for inverter operation and on the **Settings** page, select **Inverter settings**.

### INFO

Observe national regulations! In France, in particular, the inverter and the supply lines must be labelled, for example.

The installer is responsible for obtaining and affixing the prescribed markings.

✓ The inverter is in operation and can now be used. Initial commissioning is completed.

The following settings still need to be configured after initial commissioning:

- Inverter settings made by the installer
- Prescribed settings for grid feed-in by the energy supply company



1

2

3

4

5

6

7

8

9

10

11

- Change the password or update the inverter software.



# 5. Operation and operating the device

5.1	Switching on the inverter.....	73
5.2	Switching off the inverter.....	74
5.3	De-energising the inverter .....	75
5.4	Operational statuses of inverter .....	77
5.5	Status LEDs.....	78
5.6	Status display via app .....	79



## 5.1 Switching on the inverter

1. Activate supply voltage via the line circuit breaker.

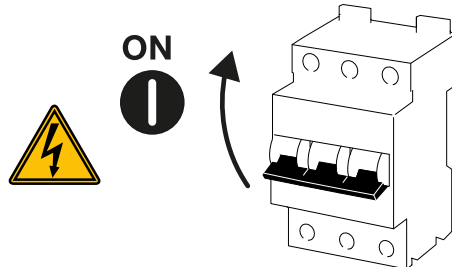

2. Move the DC switch on the inverter to **ON**.

### **i** INFO

As soon as one of the DC switches is set to **ON**, the inverter starts up.

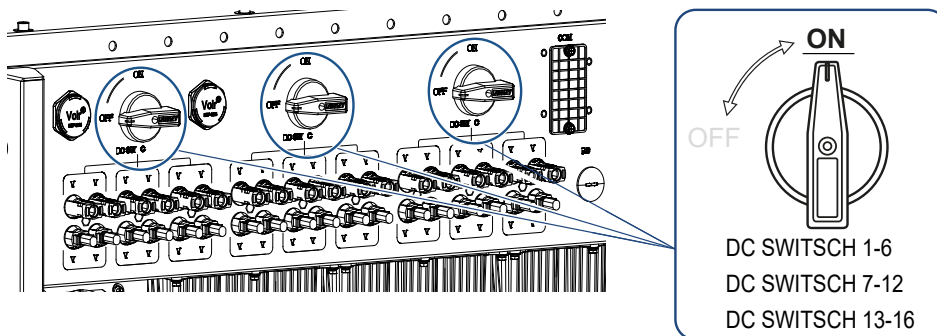

- The inverter starts up.
- The LEDs light up briefly during start-up.
- After startup, the LEDs indicate the operational status of the inverter.

### **i** INFO

When the inverter is commissioned for the first time, it goes into the **Off (Shutdown)** status.

When this happens, first carry out initial commissioning.

- ✓ The inverter is in operation.

## 5.2 Switching off the inverter

### **i** INFO

For maintenance work on the inverter, disconnect the device completely. **De-energising the inverter, Page 75**

To switch off the inverter, carry out the following steps:

1. Switch off line circuit breaker.

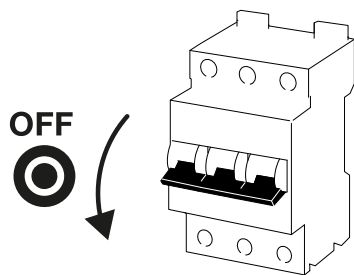

2. Switch the DC switch on the inverter to **OFF**.

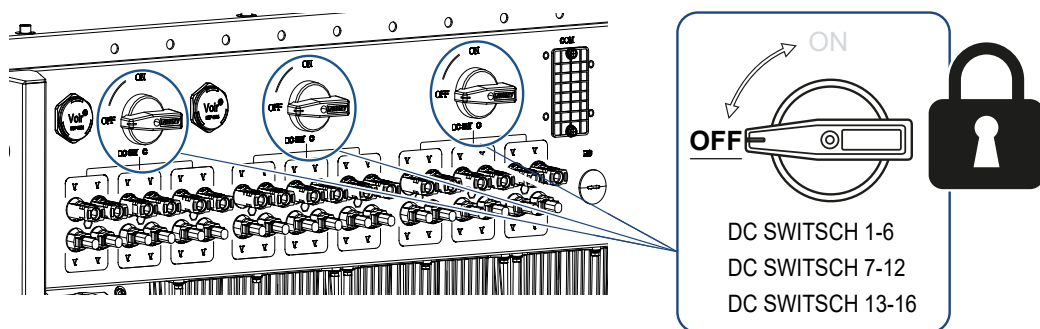

- ✓ The inverter is switched off.

The inverter remains energised and monitoring is still performed.

## 5.3 De-energising the inverter

For maintenance work on the inverter, especially on the connections, the inverter must be disconnected from the power supply.

- For work on the AC side, e.g. on the energy meter, the earthing system or the communication connections, it is sufficient to disconnect the AC connection.
- For work on the PV modules or the DC feed lines, disconnect the DC connections.
- When working in the terminal compartment of the inverter, the inverter must be completely voltage-free on the AC and DC sides.

### Disconnecting inverter on the AC side

1. Switch off AC line circuit breaker and secure it against being switched on again.

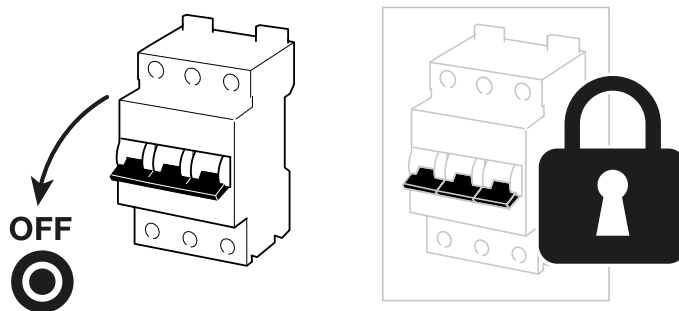

2. Switch DC switch on inverter to **OFF** and secure it against being switched on again.

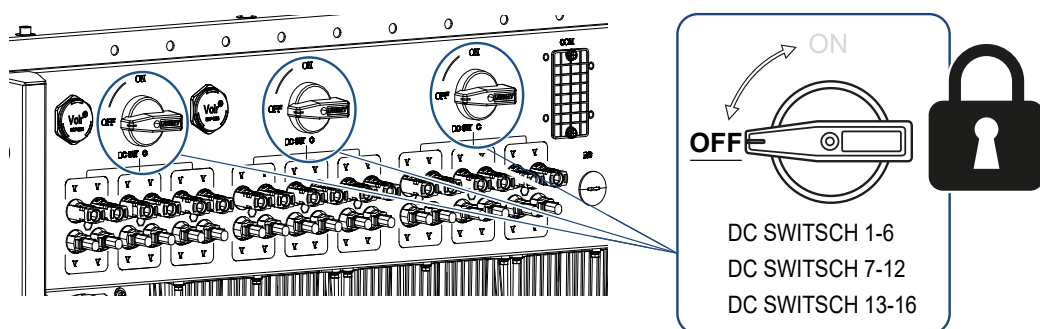

- ✓ The inverter is voltage-free on the AC side.

### Disconnecting DC cables

The inverter must first be de-energised on the AC side. Then all DC connections on the inverter can be disconnected. You will need the disassembly tool supplied with the device.



1

2

3

4

5

6

7

8

9

10

11

**DANGER****Risk of death due to electrical shock and discharge!**

When working in the terminal compartment, on the DC supply lines or on the PV modules, the DC cables must still be disconnected.

1. De-energise all devices and secure them against being switched on again.

**INFO**

PV generators/cables may be live as soon as they are exposed to light.

2. Disconnect the DC cables by interrupting the connections to the PV modules.  
If it is not possible to disconnect the DC cables, observe the rules for working under voltage:
  - Use personal protective equipment, hard hat, visor or goggles, protective suit, insulating gloves.
  - Use an insulating protective mat as an underlay.
3. Insert the disassembly tool into the plug's side release openings so that the plug is unlocked and separated from the socket by approx. 1.5 mm.

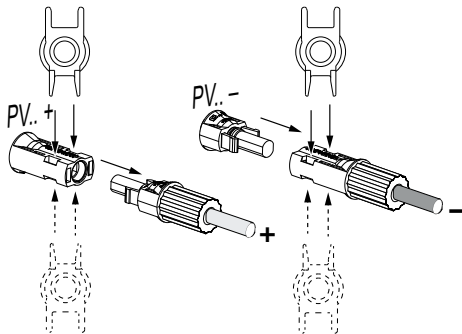

4. Remove plug from the socket.
  5. Ensure that the disconnected DC cables are protected against both weather (rain) and unauthorized access.
  6. Check that all connections on the inverter are voltage-free.
  7. Wait at least 10 minutes before carrying out any further work on the inverter so that the capacitors contained in it can discharge.
- ✓ The inverter is isolated on the DC side and voltage-free.



1

2

3

4

5

6

7

8

9

10

11

## 5.4 Operational statuses of inverter

After switching on, the inverter is always in one of the following operational statuses:

Operational status	Description
Standby	<p>The connected PV modules are not supplying enough energy to feed it into the power grid.</p> <p>As soon as the required conditions are met, the inverter switches to the <b>Feed in</b> status.</p>
Feed in	<p>The inverter is generating electrical energy and feeding it into the connected power grid.</p>
Off (Shutdown)	<p>The inverter is switched off due to a switch-off command or an error that has occurred.</p> <p>As soon as the inverter receives a power-up command or the error is corrected, the inverter switches to the <b>Standby</b> status.</p>



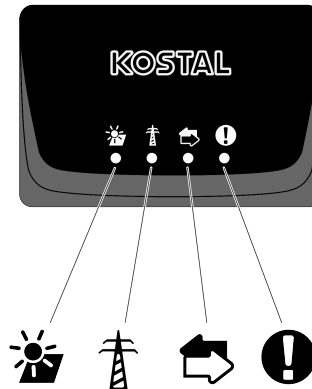

## 5.5 Status LEDs



The LEDs on the front indicate the current operational status.

Further status information can be read with the help of the app or via the .

Measures to rectify events can be found in the chapter **Event codes, Page 119.**

Meaning	State	Description
 PV inputs	Lights up	The input voltage is within the operating range
	Flashes	Overvoltage/undervoltage
 Feed-in	Off	The inverter does not feed in
	Lights up	The inverter feeds energy into the grid. Every 30 seconds the inverter reports its current power: flashes once: < 20 % Flashes twice: < 40 % Flashes 3x: < 60 % Flashes 4x: < 80 % Flashes 5x: < 100 %
	Continuous flashing	The state of the power grid does not allow any feed-in.
 Communication	Off	No connection active or no communication
	Flashes	The inverter is communicating with another device.
 Fault	Off	No fault
	Lights up or flashes	A fault has occurred

## 5.6 Status display via app

The smartphone app displays the current operational status, the power output and the current measuring values from inverter operation.

### **i** INFO

The user interface in the app depends on the installed firmware (FW) and version of the app used and may differ from the description here.

### App area Home page > Operational status



- 1 Current operational status
- 2 Connection status to the router
- 3 Energy generated
- 4 Current measuring values
- 5 Selection of the **Home** page
- 6 Selection of the **Settings** page

Further information on the app: [KOSTAL PIKO CI App, Page 81.](#)



# 6. KOSTAL PIKO CI app

6.1	KOSTAL PIKO CI App.....	81
6.2	Installation of the KOSTAL PIKO CI app .....	82
6.3	Connecting inverters with KOSTAL PIKO CI app .....	83
6.4	Logging in as an installer .....	84
6.5	KOSTAL PIKO CI app - menu structure .....	85
6.6	KOSTAL PIKO CI app - menu description .....	90





## 6.1 KOSTAL PIKO CI App

The app, which is available free of charge, provides a graphical user interface.

The app is used to commission and configure the inverter and to display its status:

- Log in on inverter
- Update inverter firmware
- Log in as user or administrator
- Status request
- Current feed-in values at grid connection
- Display of the log data
- Inverter version display
- Inverter configuration  
(e.g. LAN connection, setting up the energy meter, etc.)



1

2

3

4

5

6

7

8

9

10

11

## 6.2 Installation of the KOSTAL PIKO CI app



Download the app from the Apple App Store or Google Play Store onto your tablet or smartphone and install it.



1

2

3

4

5

6

7

8

9

10

11

## 6.3 Connecting inverters with KOSTAL PIKO CI app

The app is opened and launched via a smartphone or tablet. To do this, the smartphone or tablet must be within range of the inverter.

1. Enable the Bluetooth function on your tablet or smartphone.
2. Switch on the inverter.
3. Launch the app.
4. Select Bluetooth as the connection in the app.  
→ The list of inverters appears.
5. If the inverter is not yet included in the list, go to **Scan for new device** and scan the serial number on the type plate
- ✓ When the app displays the message **Connect**, the inverter is connected.



1

2

3

4

5

6

7

8

9

10

11

## 6.4 Logging in as an installer

Once the app is connected to an inverter, you can see all the values. However, some settings can only be changed by an installer/administrator. This requires a change of user.

To do this, proceed as follows:

1. In the app, select the **Settings** page.  
→ On the **Settings** page, the app shows you various menus where you can configure settings.
2. In order to have access to all relevant settings, go to **User management** and then touch the **Change user** button.
3. Select **Installer**.
4. Enter the password and select **Login**.



### INFO

The default password for the installer/administrator is **superadmin**.

With this user, a variety of settings can be configured vis-à-vis the system operator, such as network settings, power limitations or grid guidelines.

This password should be changed after the initial commissioning. If you forget your password, it can be reset via the service.

- ✓ You are now logged in as an installer.

### Configuring settings

Now configure the settings of the inverter as required.



1

2

3

4

5

6

7

8

9

10

11

## 6.5 KOSTAL PIKO CI app - menu structure

Deviations due to software versions are possible.

### Event messages

Level 1

*Event messages information*

### Generation

Level 1

*Day/month/year energy*

### Basic settings

Level 1

**Basic information**

*Type*

*Serial number*

*Firmware version*

*Internal code*

*Modbus version*

*Communication board version*

*Update CSB firmware*

*Update CB firmware*

**Operation**

*Switch on the inverter*

*Switch off the inverter*

*Reset to factory settings*

*Activate external shutdown*

**Data management**

*Export event messages*

*Export generation data*

*Export configuration*

*Configuration import*

**About**



1

2

3

4

5

6

7

8

9

10

11

## Level 1

*App version***User management**

## Level 1

*Change user**Changing installer password for login*

(only possible by installer)

## Level 2

Log in as system operator

Log in as installer

Forgotten password  
(reset installer password)

Change password for the installer.

**Communication settings**

## Level 1

*WLAN settings**LAN settings**RS485 settings**Master/slave settings*

## Level 2

*WLAN IP**Select WLAN connection**Change local WLAN password**IP mode**IP address**Subnet mask**Router/gateway**Auto DNS**DNS server 1**DNS server 2**Last time of communication**Last status of communication**Baud rate**Data bit**Stop bit**Parity bit**Terminating resistor**Modbus address**Master/slave settings*



1

2

3

4

5

6

7

8

9

10

11

## Inverter settings

Level 1	Level 2	Level 3
<b>Time setting</b>	<b>Synchronize inverter time</b>	
<b>Grid settings</b>	<b>Frequency monitoring of level 1 activated</b>	
	<b>PV string monitoring</b>	
	<b>Grid guideline</b>	
	<b>Start up time (s)</b>	
	<b>Start up time following grid error (s)</b>	
	<b>Power gradient (%/min)</b>	
	<b>Power gradient following grid error (%/min)</b>	
	<b>Overfrequency limit value x (Hz)</b>	
	<b>Underfrequency limit value x (Hz)</b>	
	<b>Overvoltage limit value x (V)</b>	
	<b>Undervoltage limit value x (V)</b>	
	<b>Overfrequency switch-off time x time (s)</b>	
	<b>Underfrequency switch-off time x time (s)</b>	
	<b>Overvoltage switch-off time x time (s)</b>	
	<b>Undervoltage switch-off time x time (s)</b>	
	<b>Max. grid start voltage (V)</b>	
	<b>Min. grid start voltage (V)</b>	
	<b>Max. grid start frequency (Hz)</b>	
	<b>Min. grid start frequency (Hz)</b>	
	<b>Moving average</b>	

Level 1	Level 2	Level 3
<i>Power adaptation/controls</i>	<i>Active power control</i>	<i>P(U) regulation</i>
		<i>P(F) regulation</i>
		<i>Power gradient (%/s)</i>
		<i>Maximum active power (%)</i>
		<i>Maximum feed-in capacity (W)</i>
		<i>With P(U) regulation active</i>
		<i>P(U) start voltage node x voltage (V)</i>
		<i>P(U) power gradient node x power (%)</i>
		<i>P(U) set time (S)</i>
		<i>With P(F) regulation active</i>
		<i>P(f) overfrequency gradient (%)</i>
		<i>Activation frequency (Hz)</i>
		<i>Deactivation frequency (Hz)</i>
		<i>P(f) underfrequency gradient (%)</i>
		<i>Reactive power control</i>
	<i>Reactive power mode</i>	
	<i>Energy management</i>	<i>External sensor</i>
		<i>Sensor position</i>
		<i>Modbus address of energy meter</i>
		<i>Limitation of the active power to (W)</i>
		<i>IP address of energy meter</i>
		<i>L1-3 grid power</i>
		<i>Total energy</i>
		<i>Total feed-in energy</i>
		<i>L1-3 consumer power</i>
		<i>Total consumption</i>
		<i>L1-3 inverter output</i>
		<i>Total inverter output</i>





1

2

3

4

5

6

7

8

9

10

11

Level 1	Level 2	Level 3	
	<i>Ripple control receiver (RCR)</i>	<i>Activate ripple control receiver</i> <i>RCR active power (%)</i> <i>RCR reactive power (%) / power factor cos phi</i>	
<i>Other settings</i>	<i>Isolated network detection</i>		
	<i>Residual current monitoring</i>		
	<i>Type A RCD compatible</i>		
	<i>Shadow management</i>		
	<i>Shadow management interval time (s)</i>		
	<i>Insulation resistance (kOhm)</i>		
	<i>Leakage current limit (mA)</i>		
	<i>Limit for unbalanced voltage (%)</i>		
	<i>Dynamic grid support (FRT = Fault Ride Through)</i>		<i>Positive sequence K factor</i>
			<i>Negative sequence K factor</i>
		<i>Monitoring of supply voltage</i>	
		<i>Undervoltage ride through (V) UVRT</i>	
		<i>Overvoltage ride through (V) OVRT</i>	
	<i>Grid support mode</i>		
		<i>Limited grid support (%)</i>	
		<i>Irregular voltage change (%)</i>	
	<i>Overvoltage protection monitoring</i>		



1

2

3

4

5

6

7

8

9

10

11

## 6.6 KOSTAL PIKO CI app - menu description

The following menus are available to the user in the app.

Parameter	Explanation
<b>START</b>	Connect the smartphone/tablet to the inverter's WLAN.
<b>DOWNLOAD UPDATE FILES</b>	Download the update files from the server. These are stored on the smartphone/tablet in the <b>KOSTAL PIKO CI</b> folder. To do this, the smartphone/tablet must not be connected to the inverter's WLAN. Otherwise, there is no Internet connection.



1

2

3

4

5

6

7

8

9

10

11

## Home page

On the home page, the user is shown a status overview for the inverter. This includes:

- Inverter status
- WLAN connection status between router and inverter
- Event messages
- Performance diagram
- Current measuring values

Parameter	Explanation
<b>Power limitation status</b>	Status / current power limitation
<b>Status of ripple control receiver (RCR)</b>	Status / current setting of the ripple control receiver (RCD)
<b>External shutdown status</b>	Status of the central grid and system protection
<b>Power reduction status</b>	Status / current power reduction
<b>Current power</b>	Measuring value of the electrical power currently being generated in kilowatts (kW)
<b>Today's yield</b>	Measuring value of the energy generated on the current date in kilowatt hours (kWh)
<b>Total yield</b>	Measuring value of the energy generated up to the current date
<b>Maximum power</b>	Measuring value of the highest generated power up to the current date (kW)
<b>Temperature</b>	Current ambient temperature of the inverter
<b>MPPTx voltage</b>	Measuring value of the current input voltage of PV groups 1 to 4
<b>MPPTx current</b>	Measuring value of the current input current of PV groups 1 to 4
<b>Output voltage Lx-Ly</b>	Voltage of phases L1-L3
<b>Output current Lx</b>	Current of phases L1-L3
<b>Power factor</b>	Power factor ( $\cos\phi$ ) of the currently delivered electrical power
<b>Grid frequency</b>	Output frequency of the alternating current currently being generated
<b>Active power</b>	Measuring value of the active power currently being generated
<b>Reactive power</b>	Measuring value of the reactive power currently being generated



## Settings

This menu item can be used to retrieve inverter data and configure the inverter. These include:

- Inverter messages/events
- Generation data
- Basic information/settings  
(e.g. device information, reset inverter to factory settings, export log data)
- Access management  
(user management, change password)
- Communication setting  
(e.g. Ethernet (LAN)/WLAN/WiFi/RS485 settings)
- Inverter setting  
(e.g. time/date, grid guideline, etc.)

## Event messages

Parameter	Explanation
<b><i>Event messages information</i></b>	Display of events in the inverter. Further information about the events and possible error rectification:  <b>Event codes, Page 119.</b>

## Generation

Parameter	Explanation
<b><i>Day/month/year energy</i></b>	Indication of energy generated in diagram form for day/month/year.



1

2

3

4

5

6

7

8

9

10

11

## Basic settings

Basic information	Explanation
<b>Type</b>	Inverter model.
<b>Serial number</b>	Inverter serial number.
<b>Firmware version</b>	Inverter safety firmware version. Contains the safety, open and shutdown functions required for appliance safety and grid service functions.
<b>Internal code</b>	Controller board (CB) firmware version
<b>Modbus version</b>	Modbus version used in the inverter.
<b>Communication board version</b>	Communication board firmware version
<b>Update CSB firmware</b>	Update the firmware for the communication board (CSB). The firmware must be downloaded beforehand via the <b>Download Updates Files</b> button on the start screen.
<b>Update CB firmware</b>	Update the firmware for the controller board (CB). The firmware must be downloaded beforehand via the <b>Download Updates Files</b> button on the start screen.

Operation	Explanation
<b>Switch on the inverter</b>	Switch on the inverter.
<b>Switch off the inverter</b>	Switch off the inverter.
<b>Reset to factory settings</b>	Reset the inverter parameters to factory settings.
<b>Activate external shutdown</b>	Activate central grid and system protection monitoring in the inverter. Further information  <b>KOSTAL PIKO CI App, Page 81</b> .

Data management	Explanation
<b>Export event messages</b>	Export log data (event messages/generation data/configuration data of the inverter)  <b>Retrieving log data, Page 104</b> . These are stored in the root directory on the smartphone.
<b>Export generation data</b>	
<b>Export configuration</b>	
<b>Configuration import</b>	Import configuration data of inverter.



1

2

3

4

5

6

7

8



9

10

11

About	Explanation
<i>App version</i>	Version of the app.

### See also

-  Retrieving log data [[▶ 104](#)]
-  KOSTAL PIKO CI App [[▶ 81](#)]



1

2

3

4

5

6

7

8

9

10

11

## User management

Parameter	Explanation
<b>Change user</b>	Change of user ( <i>installer</i> or <i>system operator</i> ).
<b>Change installer password for login</b>	Change <i>installer</i> password. By default, the password is <i>superadmin</i> .

## Communication settings

WLAN settings	Explanation
<b>WLAN IP</b>	WLAN IP address of the inverter WiFi module.
<b>Select WLAN connection</b>	Selection of WLAN router with password (connection of inverter to WLAN router).
<b>Change local WLAN password</b>	Change the inverter's WLAN password. By default this is <b>12345678</b>

LAN settings	Explanation
<b>IP mode</b>	The option <b>Automatically acquire IP address</b> is activated by default. This means that the inverter obtains its IP address from a DHCP server.
<b>IP address</b>	Enter IP address of inverter.  If the inverter is not allocated an IP address automatically through a DHCP server, the inverter can be configured manually.  The data necessary for configuration, such as IP, subnet mask, router and DNS addresses, can be found on your router/gateway.
<b>Subnet mask</b>	Enter the subnet mask e.g. 255.255.255.0
<b>Router/gateway</b>	Enter the IP address of the router/gateway
<b>Auto DNS</b>	The <b>Auto DNS</b> option is activated by default. This means that inverters can also be addressed using a name instead of an IP address. For this purpose, the IP addresses of the DNS servers must be entered.
<b>DNS server 1</b>	Enter the IP address of the DNS server (Domain Name System)



1

2

3

4

5

6

7

8

9

10

11

LAN settings	Explanation
<b>DNS server 2</b>	Enter the IP address of the backup DNS server (Domain Name System)
<b>Last time of communication</b>	Shows when communication with the inverter last took place.
<b>Last status of communication</b>	Shows the status of communication with the grid.

RS485 settings	Explanation
<b>Baud rate</b>	RS485 transmission rate
<b>Data bit</b>	RS485 data bit
<b>Stop bit</b>	RS485 stop bit
<b>Parity bit</b>	RS485 parity bit
<b>Terminating resistor</b>	Activate terminating resistor for the RS485 bus. This must be activated on the last inverter connected to the RS485 bus.
<b>Modbus address</b>	Modbus address

Master/slave settings	Explanation
<b>Master/slave settings</b>	Select whether the inverter should act as a master (LAN or RS485) or slave. If set as master inverter, information or setting parameters (e.g. during power reduction) are sent to the slave inverters.





1

2

3

4

5

6

7

8

9

10

11

## Inverter settings

Time setting	Explanation
<b><i>Synchronize inverter time</i></b>	Synchronize the time of the inverter with the time of the smartphone.

The following menu items can be used to set the parameters in the inverter, which are specified by the grid operator. Parameters may only be changed on the inverter by qualified electricians who are familiar with the system and at the request of the grid operator. Inappropriate settings can be hazardous and lead to injury or even death of the user or third parties. Material damage to the device and other equipment can also occur.

Grid settings	Explanation
<b><i>Frequency monitoring of level 1 activated</i></b>	Activate/deactivate frequency monitoring level 1
<b><i>PV string monitoring</i></b>	If the function is activated, one value per PV string is displayed on the home page.  In addition, an event is output if the polarity of the PV string is reversed.
<b><i>Grid guideline</i></b>	Select grid guideline (e.g. VDE-AR-N 4105)
<b><i>Start up time (s)</i></b>	Start-up waiting time after switching on the inverter
<b><i>Start up time following grid error (s)</i></b>	Start-up time following inverter grid error
<b><i>Power gradient (%/min)</i></b>	Power gradient after switching on the inverter
<b><i>Power gradient following grid error (%/min)</i></b>	Power gradient after grid error of the inverter
<b><i>Overfrequency limit value x (Hz)</i></b>	Set overfrequency limit threshold value
<b><i>Underfrequency limit value x (Hz)</i></b>	Set underfrequency protection threshold value
<b><i>Overvoltage limit value x (V)</i></b>	Set overvoltage protection limit value
<b><i>Undervoltage limit value x (V)</i></b>	Set undervoltage protection limit value
<b><i>Overfrequency switch-off time x time (s)</i></b>	Set overfrequency switch-off time
<b><i>Underfrequency switch-off time x time (s)</i></b>	Set underfrequency shut-off time
<b><i>Overvoltage switch-off time x time (s)</i></b>	Set overvoltage switch-off time



1

2

3

4

5

6

7

8

9

10

11

Grid settings	Explanation
<b>Undervoltage switch-off time x time (s)</b>	Set undervoltage switch-off time
<b>Max. grid start voltage (V)</b>	If the supply voltage is higher than the upper limit of the reconnection voltage after the inverter has been shut down for protection due to a fault, the inverter may not be reconnected to the grid.
<b>Min. grid start voltage (V)</b>	After the inverter is shut down for protection due to a fault, if the supply voltage is lower than the lower limit of the reconnection voltage, the inverter may not be reconnected to the grid.
<b>Max. grid start frequency (Hz)</b>	After the inverter is shut down for protection due to a fault, if the grid frequency is higher than the upper limit of the reconnection frequency, the inverter may not be reconnected to the grid.
<b>Min. grid start frequency (Hz)</b>	After the inverter is shut down for protection due to a fault, if the grid frequency is lower than the lower limit of the reconnection frequency, the inverter may not be reconnected to the grid.
<b>Moving average</b>	Set 10 minutes of average overvoltage value

Power adaptation/ controls	Explanation
<b>Active power control</b>	Active power control
<b><i>P(U) regulation</i></b>	Parameter of the P(U) curve, which reduces the active power if the output voltage exceeds a certain value
<b><i>P(F) regulation</i></b>	Parameter of the P(f) curve, which decreases the active power during overfrequency or increases the active power during underfrequency
<b><i>Power gradient (%/s)</i></b>	Set the power gradient. The power gradient indicates how quickly the power is to be increased or decreased.
<b><i>Maximum feed-in capacity (W)</i></b>	Set the inverter's maximum active power
<b><i>Maximum active power (%)</i></b>	Setting for maximum output power of the inverter
<b>Reactive power control</b>	Reactive power control



1

2

3

4

5

6

7

8

9

10

11

Power adaptation/ controls		Explanation
	<b>Settling time of reactive power</b>	Specifies the reactive power settling time (3 Tao, PT-1 behaviour)
	<b>Reactive power mode</b>	Specifies the reactive power control mode. Configure settings according to the power supply company for reactive power control.
<b>Energy management</b>		Power limitation
	<b>External sensor</b>	<b>Deactivated:</b> No energy meter connected to the inverter. <b>KSEM:</b> A is connected to the inverter.
	<b>Sensor position</b>	Installation position of energy meter (grid connection point or consumer) Connecting the KOSTAL Smart Energy Meter
	<b>Modbus address of energy meter</b>	Energy meter Modbus address
	<b>Limitation of the active power to (W)</b>	Set up power limitation
	<b>IP address of energy meter</b>	Energy meter IP address
	<b>L1-3 grid power</b>	Displays the grid power at the individual phases
	<b>Total energy</b>	Shows the energy supply from the public grid
	<b>Total feed-in energy</b>	Shows the feed-in into the public grid
	<b>L1-3 consumer power</b>	Shows the consumer power at the individual phases
	<b>Total consumption</b>	Shows the total consumption
	<b>L1-3 inverter output</b>	Shows the inverter output at on the individual phases
	<b>Total inverter output</b>	Shows the total energy generated by the inverter
<b>Ripple control receiver</b>		Ripple control receiver control
	<b>Activate ripple control receiver</b>	Activate/deactivate ripple control receiver function Connecting ripple control receiver
	<b>RCR active power (%)</b>	Set active power value for ripple control receiver
	<b>RCR reactive power</b>	Set reactive power value or power factor cos phi for ripple control receiver



1

2

3

4

5

6

7

8

9

10

11

Other settings	Explanation
<b>Isolated network detection</b>	Activate/deactivate isolated network detection. Ensures that the inverter does not switch on or off in the event of supply voltage errors.
<b>Residual current monitoring</b>	Activate/deactivate residual current monitoring. When the function is enabled, the inverter detects the array fault current.
<b>Compatibility of type A RCD</b>	If this function has been activated, type A RCDs can be used as residual current protection equipment. In such cases, the inverter shuts down when the residual current becomes incompatible with a type A RCD. If the function is deactivated, a type B RCD must be used as residual current protection equipment if an RCD is stipulated.
<b>Shadow management</b>	If PV strings are in partial shading, the PV string affected no longer achieves its optimum performance. If shadow management is activated, the inverter adapts the MPP tracker in such a way that it can operate at maximum possible performance.
<b>Shadow management interval time (s)</b>	Set the interval of the MPP tracker sampling rate
<b>Insulation resistance (kOhm)</b>	If the value established for insulation resistance is less than the preset value, the inverter is not connected to the grid
<b>Leakage current limit (mA)</b>	Limit value for leakage current detection. If the value established is higher than the preset value, the inverter will shut down.
<b>Limit for unbalanced voltage (%)</b>	Set threshold value for supply voltage unbalance
<b>Dynamic grid support (FRT)</b>	Dynamic grid support (FRT = Fault Ride Through)
<b>Positive sequence K factor</b>	Settings for uninterrupted cycling through grid faults FRT (Fault Ride Through)
<b>Negative sequence K factor</b>	
<b>Monitoring of supply voltage</b>	
<b>Undervoltage ride through (V) UVRT</b>	



1

2

3

4

5

6

7

8

9

10

11

Other settings	Explanation
<i>Overvoltage ride through (V) OVRT</i>	
<i>Grid support mode</i>	
<i>Limited grid support (%)</i>	
<i>Irregular voltage change (%)</i>	
<b>Overvoltage protection monitoring</b>	Activate/deactivate monitoring of the internal overvoltage protection modules (SPD - Surge Protective Device).



# 7. System monitoring

7.1	The log data.....	103
7.2	Retrieving log data .....	104
7.3	The KOSTAL Solar Portal.....	106
7.4	Park control .....	107



## 7.1 The log data

The inverter is equipped with a data logger, which regularly records data from the system.

The log data can be used for the following purposes:

- Check operating characteristics of the system
- Determine and analyse errors
- Download and graphically depict yield data



1

2

3

4

5

6

7

8

9

10

11

## 7.2 Retrieving log data

There are several options for retrieving and permanently storing the log data:

- **Option 1:** Download and display log data via the app
- **Option 2:** Transfer log data to a solar portal and display it

### Option 1: Download and display log data via the KOSTAL PIKO CI app

A range of inverter data can be exported.

- Event messages
  - Generation data
  - Inverter configuration data
1. In the app, go to **Settings > Basic settings > Export event messages**.  **KOSTAL PIKO CI app - menu structure, Page 85**
  2. Confirm the download.
- ✓ The log data can be saved to a computer and displayed and further processed with any common spreadsheet program (e.g. Excel).





## Option 2: Transfer log data to the KOSTAL Solar Portal and display it

With a solar portal it is possible to monitor the PV system and performance data via the Internet.

The has the following functions, which, however, may differ depending upon the portal:

- Graphic depiction of performance data
- Worldwide online access to the portal
- Email notification of errors
- Data export (e.g. Excel file)
- Long-term storage of log data

### Data transfer to the :



#### INFO

A correctly set-up network connection/Internet connection is a prerequisite for data transfer.

It may take as long as 20 minutes following activation until the data export is visible on the .

The can be accessed using the following link: [www.kostal-solar-portal.com](http://www.kostal-solar-portal.com).

- The inverter has an Internet connection.
- The inverter is registered on the .
- The activation of data transfer is activated in the inverter by default.



1

2

3

4

5

6

7

8

9

10

11

## 7.3 The KOSTAL Solar Portal

The solar portal of is a free Internet platform for monitoring the PV system.

The inverter sends the PV system's yield data and event messages to the via the Internet.

The information is stored in the . You can view and call up this information via the Internet.



### Conditions for use

- The inverter must have a connection to the Internet.
- The inverter must not yet be registered on the .
- The inverter must not yet be assigned to a plant.

To use the , follow these three steps:

- Data transfer to must be activated in the inverter. With the , this activation is activated by default.
- You must register on the website of to use the . Registration is free.
- If the is connected to a , the must also be set up in the to display the self-consumption values.

## 7.4 Park control

If the inverter is controlled centrally via a PGS park controller, certain settings should be configured in the inverter.

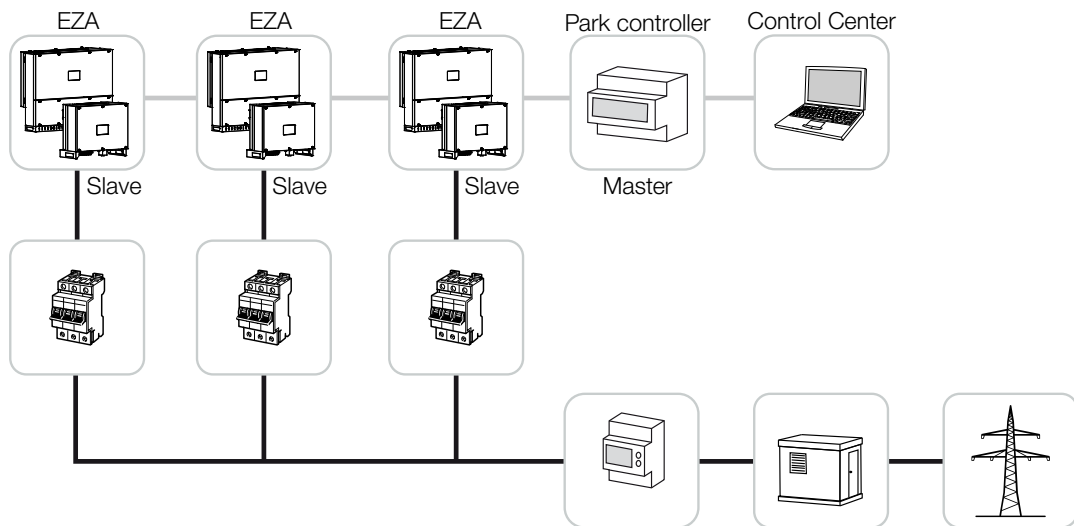

The following settings must be configured:

- Activate inverter as slave.  
Set by going to **Settings > Communication settings > Master/Slave settings > Slave**.
- Deactivate PLF (power limitation).  
Deactivate by going to **Settings > Inverter settings > Power adaptation/controls > Energy management > External sensor**.
- Deactivate RCR (ripple control receiver).  
Deactivate by going to **Settings > Inverter settings > Power adaptation/controls > Ripple control receiver (RCR) > Ripple control receiver**.
- Deactivate reactive power ramp.  
Set to 0 by going to **Settings > Inverter settings > Power adaptation/controls > Reactive power control > Reactive power settling time (s)**.
- Activate reactive power mode.  
Activate by going to **Reactive power mode > Pure Active power**.

The following settings are dependent on the PGS park controller. Please contact the manufacturer of the PGS park controller to find out which setting you need.

- Deactivate active power ramp if necessary.  
Set to 2 by going to **Settings > Inverter settings > Power adaptation/controls > Active power control > Power gradient (%/s)**.
- Activate P(f) control (control is handled by the inverter).
- Deactivate P(U) control (control is handled centrally by the park controller).



1

2

3

4

5

6

7

8

9

10

11

In the PGS park controller, the delay time should be set to at least 200 ms.

Other settings, which are required in the external PGS park controller / park controller, are described in the manuals for the respective PGS park controller / park controller.



# 8. Maintenance

8.1	During operation .....	110
8.2	Maintenance and cleaning .....	111
8.3	Housing cleaning .....	112
8.4	Housing cleaning .....	113
8.5	Replacing AC / DC overvoltage protection modules .....	114
8.6	Updating software.....	117
8.7	Event codes.....	119



## 8.1 During operation

Once correctly installed, the inverter runs virtually maintenance-free.

For proper operation in a larger solar system, the normal measures of regular system monitoring are fully sufficient.

In particular, tracking the energy obtained via data loggers, the or energy meters will quickly indicate irregularities. Events during operation are also logged.

For plant safety, we would recommend the maintenance work stated in the following sections.



## 8.2 Maintenance and cleaning

The following maintenance tasks are to be carried out for the inverter:



### DANGER

#### Risk of death due to electrical shock and discharge!

Life-threatening voltages are present in the inverter.

- Only a qualified electrician may open and perform work on the device.
- Disconnect all poles of the device before starting work.
- Wait at least 10 minutes after disconnecting the device until the internal capacitors have discharged.

### Maintenance list

Activity	Interval
Check operational status <ul style="list-style-type: none"> <li>■ Normal operating noise</li> <li>■ Function of all communication connections</li> <li>■ Damage or housing deformation</li> </ul>	Once a month
Electrical connections <ul style="list-style-type: none"> <li>■ Check that cable connections and plugs have good contact and are secure</li> <li>■ Check cable connections for damage or ageing</li> <li>■ Check grounding</li> </ul>	Once every six months
Clean the inverter <ul style="list-style-type: none"> <li>■ Remove soiling</li> <li>■ Check ventilation ducts, clean if necessary</li> <li>■ Remove and clean the fan if necessary</li> </ul>	Once a year

Use maintenance lists in which the work undertaken is logged.

If no maintenance work is carried out, this will result in an exclusion of warranty (see 'Exclusion of warranty' in our service and warranty conditions).



1

2

3

4

5

6

7

8

9

10

11

## 8.3 Housing cleaning

Only clean the housing with a damp cloth.

Do not use any harsh cleaning agents.

Do not use devices that produce a spray or water jet.

In particular, check the condition of the ventilation ducts and the function of the fans.





## 8.4 Housing cleaning

Only clean the housing with a damp cloth.

Do not use any harsh cleaning agents.

Do not use devices that produce a spray or water jet.

In particular, check the condition of the ventilation ducts and the function of the fans.

## 8.5 Replacing AC / DC overvoltage protection modules

Type 2 DC and AC overvoltage protection modules are fitted in the inverter to protect against overvoltage. In the event of a fault, these can be replaced. An event message is output on the inverter for this purpose.

The following module types are used:

Side	Quantity	Type
DC	13	PV DC SPD - Type 2 / PV 670-25M2-10R ( $U_{cpv}$ 670 / (8/20 $\mu$ s) In 10 kA / (8/20 $\mu$ s) I <sub>max</sub> 25 kA)
AC	3	PV DC SPD - Type 2 / PV 500-25M2-10R ( $U_{cpv}$ 500 V / (8/20 $\mu$ s) In 10 kA / (8/20 $\mu$ s) I <sub>max</sub> 25 kA)
	2	PV DC SPD - Type 2 / PV 670-25M2-10R ( $U_{cpv}$ 670 V / (8/20 $\mu$ s) In 10 kA / (8/20 $\mu$ s) I <sub>max</sub> 25 kA)

### Block diagram for AC / DC overvoltage modules

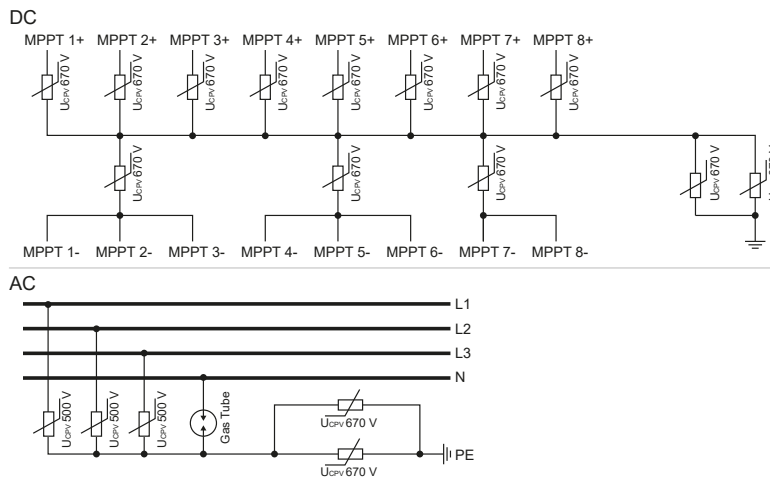

### Replacing overvoltage protection modules

1. Disconnect the power supply from the mains.



**DANGER**

**Risk of death due to electrical shock and discharge!**

De-energise device and secure against being switched on again.

2. Secure AC connection against being switched on again.
3. Switch the DC switch on the inverter to **OFF**.



1

2

3

4

5

6

7

8

9

10

11

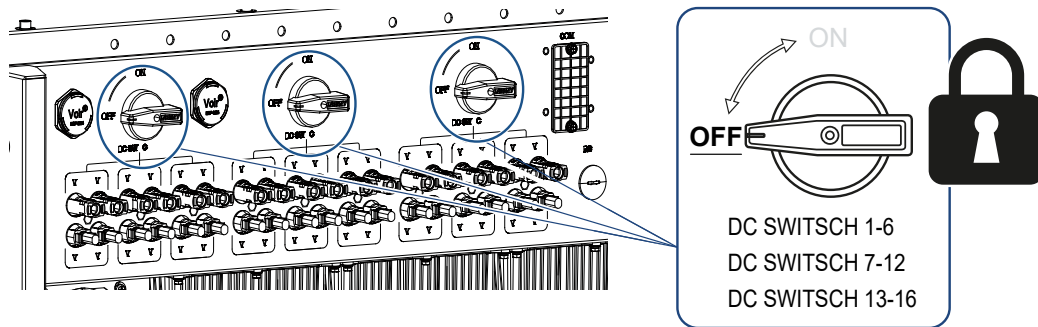
**IMPORTANT INFORMATION**

Whenever working on the inverter, only ever use insulated tools to prevent short-circuits.

4. Wait at least 10 minutes after disconnecting the unit until the internal capacitors have discharged.
5. Remove the inverter's cover and open the inverter.

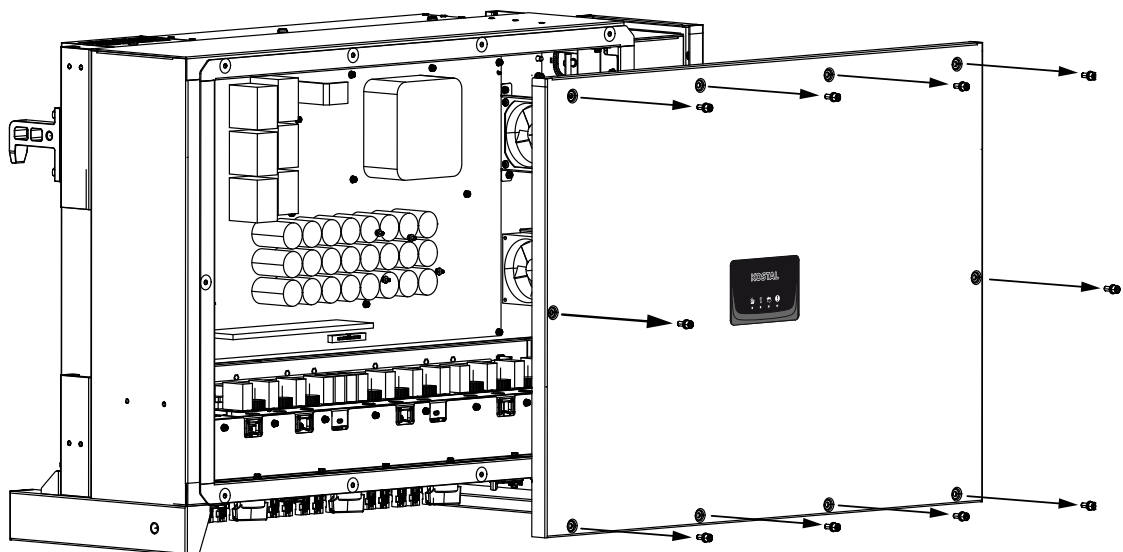

6. Remove defective overvoltage protection modules and replace with new ones. Defective modules can be recognised by a red mark in the module housing.



1

2

3

4

5

6

7

8

9

10

11

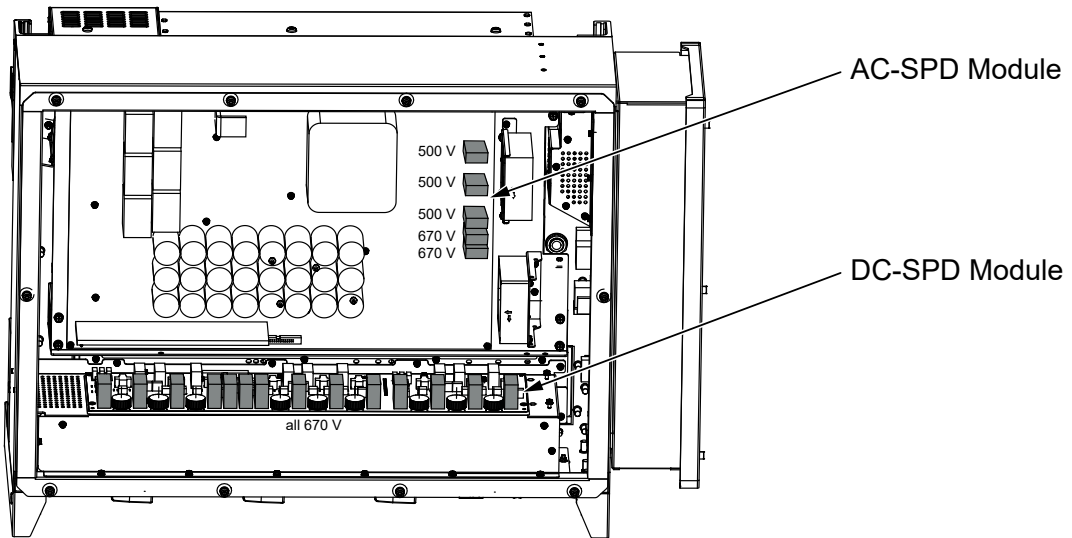

7. Install cover and screw it tight (3 Nm).
  8. Switch on the inverter again.
- ✓ The PV fuses have been replaced.



## 8.6 Updating software

If the manufacturer has updated software for the inverter, this can be loaded into the inverter. The software is updated to the latest version. If an update is available, you will find this on the manufacturer's website in the download area or you can start the update directly via the app.

### Procedure

Use a smartphone or tablet with the app installed. Proceed as follows:

1. Enable the Bluetooth function on your tablet or smartphone.
2. Launch the app.
3. Download the update files from the server by clicking on the **DOWNLOAD UPDATE FILES** button.
4. Select Bluetooth as the connection in the app.  
→ The list of inverters appears.
5. If the inverter isn't yet included in the list, go to **Scan for new device**.
6. For the update to be imported, the user must be changed. Go to **Settings > User management > Change User**.
7. Go to **Login as installer** and enter the relevant password.



### INFO

The default password for the installer/administrator is **superadmin**.

With this user, a variety of settings can be configured vis-à-vis the system operator, such as network settings, power limitations or grid guidelines.

This password should be changed after the initial commissioning. If you forget your password, it can be reset via the service.

8. Go to **Settings > Basic settings > Update CSB firmware**.  
→ The inverter automatically finds the update file (G711-xxxxxxx.bin) and starts the installation.
9. After the installation, wait approx. 2 minutes before installing the control board update.
10. Go to **Settings > Basic settings > Update CB firmware**.  
→ The inverter automatically finds the update file (m\_G9511-xxxxxxx.bin) and starts the installation.



1

2

3

4

5

6

7

8

9

10

11

11. Check the version of the software in the app under **Settings > Basic settings**.

**Firmware version:**

Shows the safety firmware version.

**Internal code:**

Shows the control board (CB) firmware version, e.g. 010808 = V1.8.8

**Communication board version:**

Shows the communication board (CSB) firmware version, e.g. 010806 = V1.8.6

- ✓ The update has been installed.



## 8.7 Event codes

There is no need to take action when an event occurs occasionally or only briefly and the device resumes operation. When an event lasts for long periods or recurs frequently, the cause must be determined and rectified.



### DANGER

#### Risk of death due to electrical shock and discharge!

Life-threatening voltages are present in the inverter.

- Only a qualified electrician may open and perform work on the device.

In case of a permanent event, the inverter interrupts the feed-in and switches off automatically.

- Check whether the DC switch or the external DC voltage separator has been switched off.
- Check whether the event is due to a mains power failure, or whether the fuse between the feed meter and the inverter has tripped.

In case of fuse failure, notify your installer. In the event of a power failure, wait until the grid operator has rectified the fault.

If the event lasts only a short time (grid fault, overheating, overload, etc.), then the inverter will automatically resume operation as soon as the event has been resolved.

If the event persists, notify your installer or the manufacturer's customer support team.



### INFO

Contact details can be found in the section [Warranty and service, Page 136](#).

Provide the following information:









- Device type and serial number. You will find this information on the type plate on the exterior of the housing.
- Error description  
(LED display and message in the app).

Operational statuses and error causes are reported as a combination of LED display and event code. The event code is shown in the app or in the . Determine the type of event using the table below ([Event messages, Page 120](#)).





















































If an event occurs repeatedly or permanently, or for events that are not listed in the table, please contact Service.

## Event messages

















































































### Key for LEDs/display

	LED lights up		Status of PV modules
	LED flashing		Status of grid
	Original status		Status of communication
	LED off		Warning message/alarm

### Event codes

Portal event code	Device event code	Meaning	LED			
						
-	-	Status normal				
-	-	Commissioning/start-up				
-	-	WLAN / WiFi / RS485 communication				
-	-	PV normal				
30001	A0	Grid overvoltage				
30002	A1	Grid undervoltage				
30003	A2	Grid missing				
30004	A3	Grid overfrequency				
30005	A4	Grid underfrequency				
30006	B0	PV overvoltage				
30007	B1	PV insulation fault				
30008	B2	Leakage current error				



Portal event code	Device event code	Meaning	LED			
						
30010	C0	Control power low				
30011	B3	PV string error				
30012	B4	PV undervoltage				
30013	B5	Weak PV irradiation				
30014	A6	Grid error				
30017	C2	Grid DC current share too high				
30018	C3	Inverter relay fault				
30020	C5	Inverter overtemperature				
30021	C6	Residual current monitoring fault				
30022	B7	Reverse polarity strings				
30023	C7	System error				
30024	C8	Fan blocked				
30025	C9	DC link unbalance				
30026	CA	Overvoltage of intermediate circuit				
30027	CB	Internal communication error				
30028	CC	Software incompatible				
30029	CD	EEPROM error				
30030	CE	Persistent warning				
30031	CF	Inverter error				



1

2

3

4

5

6

7

8

9

10

11

Portal event code	Device event code	Meaning	LED			
30032	CG	DC booster error				
30038	CH	Master connection lost				
30039	CJ	Meter connection lost				

If the inverter enters shutdown mode due to an event shown above, the Warning/Alarm LED will light up. The Troubleshooting table ( **Troubleshooting, Page 122**) describes actions to be taken for the most common events.

## Troubleshooting

Event code	Causes	Recommended measures
Grid overvoltage	The grid voltage exceeds its permissible range or the grid is not available.	If the alarm occurs occasionally, there may be a fault in the power supply system. No additional measures are required.  If the alarm occurs repeatedly, contact your local power company. If the fault is not due to the grid, check the grid settings of the inverter using the app.  If the alarm persists for a long time, check whether the AC line circuit breaker / AC terminals are disconnected or the grid power supply has failed.
Grid undervoltage		
Grid missing		
Grid overfrequency		
Grid underfrequency		
Grid error		
PV overvoltage	The input voltage of the PV modules exceeds the permissible range of the inverter.	Check the number of PV modules and adjust them if necessary.
PV undervoltage	The input voltage of PV modules is below the preset protection value of the inverter.	When the intensity of the sunlight is low, the voltage of the PV modules drops. No action is required.  If the intensity of sunlight is high, check for short circuits, open circuits, etc. in the PV strings.



1

2

3

4

5

6

7

8

9

10

11

Event code	Causes	Recommended measures
PV insulation fault	There is a short circuit between PV strings and protective earth. PV strings are installed in a persistently humid environment.	<p>If the alarm occurs accidentally, the external circuits (PV strings) will supply irregular values. The inverter automatically returns to normal operation after the fault has been corrected.</p> <p>If the alarm occurs repeatedly or lasts for a long time, check whether the insulation resistance of the PV strings to earth is too low.</p>
Leakage current error	The insulation resistance to earth on the input side decreases during inverter operation, resulting in too high a residual current.	<p>Check the insulation resistance to earth for the PV strings. If a short circuit has occurred, correct the error.</p> <p>If the insulation resistance to earth in a rainy environment is lower than the default value, adjust the insulation resistance in the app.</p>
Weak PV irradiation	<p>PV strings have been covered for a long time.</p> <p>PV strings deteriorate.</p>	<p>Check whether the PV string is covered.</p> <p>If the PV string is clean and not covered, check if the PV modules are ageing or if the performance has deteriorated.</p>



1

2

3

4

5

6

7

8

9

10

11

Event code	Causes	Recommended measures
PV string error	The cables of the PV strings were connected the wrong way round during inverter installation.	<p>Check that the PV string cables are correctly connected. If they are connected the wrong way round, connect the cables correctly.</p> <p><b>NOTE! If the cables for the PV strings are connected the wrong way round and the DC switch is set to ON, intervention on the switches or PV connections is not permitted. If interventions are made, the device may be damaged. Wait for a period when there is less solar irradiation, e.g. in the evening, and for the PV string current to fall below 0.5 A. Set the three DC switches to OFF and correct the PV connections.</b></p>
BUS undervoltage	An unusual internal imbalance in relation to the energy control was caused by the PV strings, which triggered a major change in working conditions in the grid.	If the alarm occurs occasionally, the inverter can automatically return to normal operation after the fault has been corrected.
BUS overvoltage		If the alarm occurs repeatedly, contact your support team for technical assistance.
Reverse polarity strings		
DC booster error		
EEPROM error	EEPROM component damaged	Please contact your support team. Replace the monitoring card.
Zero power generation and yellow alarm light, which lights up in the remote monitoring system	Communication failure	<p>If a data logger is being used, modern or otherwise, please restart the data logger.</p> <p>If the error still occurs, contact your support team.</p>
Remote monitoring system indicates zero power generation	Communication failure	<p>If a data logger is being used, modern or otherwise, please restart the data logger.</p> <p>If the error still occurs, contact your support team.</p>



1

2

3

4

5

6

7

8

9

10

11

Event code	Causes	Recommended measures
Remote monitoring system shows no output voltage	DC switch to <b>OFF</b>	Check if the DC switch is damaged, and if not, turn it to <b>ON</b> . If the error still occurs, contact your support team.
Grid error	Fault in the power supply system	Wait until power is restored.
	DC switch to <b>OFF</b>	Turn the DC switch to <b>ON</b> . If the DC switch trips frequently, contact your support.
Master connection lost	Connection between slave and master inverter is interrupted.	Check whether the communication line to the master inverter has been interrupted. If the error still occurs, contact your support team. Check the communication settings in the app.
Meter connection lost	Communication connection to energy meter (KSEM) interrupted	Check whether the communication line between the master inverter and energy meter (KSEM) has been interrupted. If the error still occurs, contact your support team. Check the communication settings in the app.



# 9. Technical information

9.1	Technical data .....	127
9.2	Block diagram.....	130



1

2

3

4

5

6

7

8

9

10

11

## 9.1 Technical data

Subject to technical changes. Errors excepted.

You can find current information at [www.kostal-solar-electric.com](http://www.kostal-solar-electric.com).

### Input side (DC)

PIKO CI	Unit	PIKO CI 100
Max. PV power ( $\cos \phi = 1$ )	kWp	150
Nominal DC power	kW	101.6
Rated input voltage ( $U_{dc,r}$ )	V	600
Start input voltage ( $U_{dc,start}$ )	V	250
Max. system voltage ( $U_{dc,max}$ )	V	1100
MPP range at rated output ( $U_{mpp,min}$ )	V	540
MPP range at rated output ( $U_{mpp,max}$ )	V	800
Operating voltage range ( $U_{mpp,workmin}$ )	V	200
Operating voltage range ( $U_{dc,workmax}$ )	V	1000*
Max. working voltage ( $U_{dc,workmax}$ )	V	1000
Max. input current ( $I_{dc,max}$ ) per MPPT	A	MPPT 1 -3: 40   MPPT 4-8: 32
Max. DC short-circuit current ( $I_{sc,pv}$ )		
Max. DC current per DC input ( $I_{stringmax}$ )	A	20
Number of DC inputs		16
Number of independent MPP trackers		8

### Output side (AC)

PIKO CI	Unit	PIKO CI 100
Rated power, $\cos \phi = 1$ ( $P_{ac,r}$ )	kW	100
Output apparent power ( $S_{ac,nom}$ , $S_{ac,max}$ )	kVA	100 / 111
Min. output voltage ( $U_{ac,min}$ )	V	322
Max. output voltage ( $U_{ac,max}$ )	V	520
Rated alternating current ( $I_{ac,r}$ )	A	145
Max. output current ( $I_{ac,max}$ )	A	168.8
Short-circuit current (peak/RMS)	A	tbd
Grid connection		3N~, 230/400 V, 50 Hz
Rated frequency ( $f_r$ )	Hz	50
Grid frequency ( $f_{min} - f_{max}$ )	Hz	45/55
Setting range for the power factor ( $\cos \phi_{AC,r}$ )		0.8...1...0.8
Power factor at rated power ( $\cos \phi_{AC,r}$ )		1
THD	%	<3
Standby	W	<1



1

2

3

4

5

6

7

8

9

10

11

## Efficiency

PIKO CI	Unit	PIKO CI 100
Max. efficiency	%	98.4
European efficiency	%	98.2
MPP adjustment efficiency	%	99.9

## System data

PIKO CI	Unit	PIKO CI 100
Topology: Without galvanic isolation – transformerless		Yes
Protection class in accordance with IEC 60529		IP66
Protective class according to EN 62109-1		I
Overvoltage category according to IEC 60664-1 on input side (PV generator)		II
Overvoltage category according to IEC 60664-1 on output side (grid connection)		III
DC/AC overvoltage protection		Type 2 (replaceable)
Degree of contamination		4
Environmental category (outdoor installation)		Yes
Environmental category (indoor installation)		Yes
UV resistance		Yes
AC cable diameter (min-max)	mm	24...69
AC cable cross-section (min-max)	mm <sup>2</sup>	Copper: 70...240 / aluminium: 95...240
PV cable cross-section (min-max)	mm <sup>2</sup>	4...6
Max. fuse protection on output side (AC) IEC 60898-1	A	B200 / C200
Internal operator protection in accordance with EN 62109-2		RCMU/RCCB type B
Independent disconnection device according to VDE V 0126-1-1		Yes
Height/width/depth	mm	936/678/365
Weight	kg	93
Cooling principle – regulated fans		Yes
Max. air throughput	m <sup>3</sup> /h	tbd
Noise emission (typical)	dB(A)	65
Ambient temperature	°C	-25...60
Max. operating altitude above sea level	m	4000
Relative humidity	%	0...100
Connection technology, DC side		Amphenol plug H4
Connection technology, AC side		M12



## Interfaces

PIKO CI	Unit	PIKO CI 100
Ethernet LAN TCP/IP (RJ45)		2
Wi-Fi (2.4 GHz [IEEE 802.11 b/g/n])		Yes
RS485		2
Digital inputs		4
Bluetooth		Yes

## Directives / Certification

	Directives / Certification
PIKO CI 100	EN62109-1, EN62109-2, IEC 62920, VDE-AR-N 4105:2018, PO12.2, RD 244:2019, UNE 217001, EN 50549-1 -2, CEIO-16 2019, CEIO-21 2019 >11.08kW, UK G99/1-4 LV, IRR-DCC MV 2015, IEC61727/62116

Overvoltage category III (AC output): The device is suitable for permanent connection in the grid distribution behind the meter and the line protection fuse. If the connection cable travels outdoors over long distances, overvoltage protection devices may be necessary.

Overvoltage category II (DC input): The device is suitable for connection to PV strings. Long feed cables out of doors or a lightning protection system in the vicinity of the PV system may make lightning protection or surge protection equipment necessary.

Degree of contamination 4: Contamination results in continuous conductivity, e.g. due to conductive dust, rain or snow; indoors or outdoors.

## 9.2 Block diagram

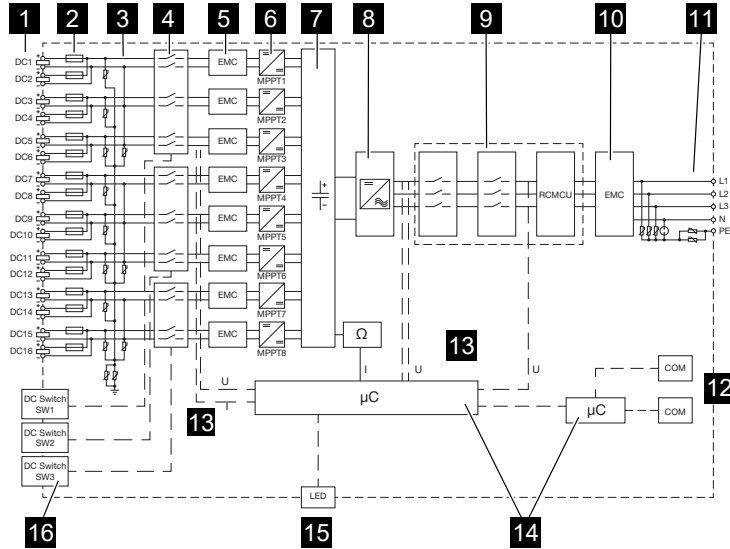

- 1 DC inputs for PV modules
- 2 DC fuses
- 3 Overvoltage protection (DC side)
- 4 Electronic DC disconnection device
- 5 EMC filter (DC side)
- 6 DC regulator
- 7 Intermediate circuit
- 8 Inverter bridge circuit
- 9 Grid monitoring and shutdown
- 10 EMC filter (AC side)
- 11 AC connection
- 12 Connection panels for communication interfaces
- 13 Voltage and current measurement
- 14 Control system and communication
- 15 Status LED
- 16 DC switch

# 10. Accessories

10.1	KOSTAL Solar App .....	132
10.2	PIKO CI app.....	133
10.3	KOSTAL Solar Portal.....	134



1

2

3

4

5

6

7

8

9

10

11

## 10.1 KOSTAL Solar App

The free KOSTAL Solar App offers you professional monitoring of your photovoltaic system. You can use the KOSTAL Solar App to simply and easily access all functions on your smartphone or tablet at any time.

To set up and use the app, you will need access to the KOSTAL Solar Portal and to have an inverter set up there. To log in to the app, you will need to use the same access data as for the KOSTAL Solar Portal.

You can use the KOSTAL Solar App to easily monitor your photovoltaic system and to display relevant system data both at home and when you are out and about. It allows you to access the consumption and generation data over various time periods, such as day, week, month and year, and to view your photovoltaic system's historical data. This means that with the KOSTAL Solar App you are always up to date.

Download the free KOSTAL Solar App today and benefit from new and advanced functionalities.

Additional information about this product is available on our website

[www.kostal-solar-electric.com](http://www.kostal-solar-electric.com) under **Products > Monitoring software > KOSTAL Solar App**.



KOSTAL Solar App





1

2

3

4

5

6

7

8

9

10

11

## 10.2 PIKO CI app

In order to operate and configure the PIKO CI inverter, you will need the PIKO CI app.



Download the app from the Apple App Store or Google Play Store onto your tablet or smartphone and install it.



## 10.3 KOSTAL Solar Portal

The KOSTAL Solar Portal allows operation of the inverters to be monitored via the Internet. This protects your investment in a PV system against yield losses, e.g. through active e-mail alerts if events occur.

Registering for the KOSTAL Solar Portal is free of charge at [www.kostal-solar-portal.com](http://www.kostal-solar-portal.com).

Functions include:

- Worldwide online access to the portal
- Graphic representation of the power and yield data
- Visualisation of data and thus being made aware of how to optimise self-consumption
- Notification of events by e-mail
- Data export
- Sensor evaluation
- Display and proof of a potential active power reduction by the grid operator
- Storage of log data for long-term and reliable monitoring of your PV system
- Providing system data for the

Additional information about this product is available on our website

[www.kostal-solar-electric.com](http://www.kostal-solar-electric.com) under **Products > Monitoring software > KOSTAL Solar Portal**.





# 11. Appendix

11.1	Warranty and service .....	136
11.2	Type plate.....	137
11.3	Handover to the operator.....	138
11.4	Decommissioning and disposal.....	139



## 11.1 Warranty and service

Information about the service and warranty conditions can be found in the download area for the product at [www.kostal-solar-electric.com](http://www.kostal-solar-electric.com).

For service information and in the event of parts being needed, we require your device type and the serial number. You will find this information on the type plate on the exterior of the housing.

If you have any technical questions, please call our service hotline:

- Germany and other countries (language: German, English):  
+49 (0)761 477 44-222
- Switzerland:  
+41 32 5800 225
- France, Belgium, Luxembourg:  
+33 16138 4117
- Greece:  
+30 2310 477 555
- Italy:  
+39 011 97 82 420
- Poland:  
+48 22 153 14 98
- Spain, Portugal (language: Spanish, English):  
+34 961 824 927

### Spare parts

If spare parts or accessories are required for troubleshooting, use only original spare parts and accessories manufactured and/or approved by the manufacturer.





1

2

3

4

5

6

7

8

9

10

11

## 11.2 Type plate

The type plate is located on the device. You will find the device type and the most important technical data listed on the type plate.

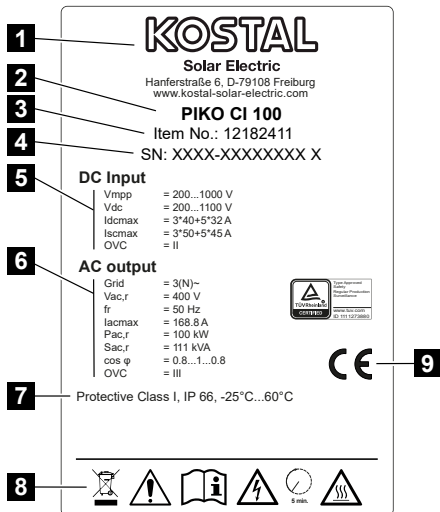

- 1 Name and address of manufacturer
- 2 Device type
- 3 KOSTAL article number
- 4 Serial number
- 5 Information on DC inputs: input voltage range, max. input voltage, max. input current (PV modules per DC group), max. short-circuit current (PV modules, per DC group), overvoltage category
- 6 Details of the AC output: number of feed-in phases, output voltage (nominal), grid frequency, max. output current, max. output power, max. output apparent power, setting range of power factor, overvoltage category
- 7 Protective class in accordance with IEC 62103, protection class, ambient temperature range, overvoltage category, requirements with which the integrated grid monitoring complies
- 8 Warning symbols
- 9 CE mark



## 11.3 Handover to the operator

Following successful installation and commissioning, all documents are to be handed over to the operator.

Instruct the operator in how to use the PV system and the inverter.

The operator must be made aware of the following points:

- Position and function of the DC switch
- Position and function of the AC line circuit breaker
- Procedure for disconnecting the device
- Safety when handling the device
- Appropriate procedure when checking and servicing the unit
- Meaning of the LEDs and the display messages
- Contact person in the event of a fault
- The provision of system and inspection documentation in accordance with DIN EN 62446 (VDE 0126-23) (optional).

As the **installer and commissioning engineer**, have the operator confirm the proper handover with their signature.

As the **operator**, have the installer and commissioning engineer confirm that the installation of the inverter and the PV system is safe and complies with standards with their signature.



## 11.4 Decommissioning and disposal

To dismantle the inverter, proceed as follows:

1. De-energise inverter on AC and DC sides ( **De-energising the inverter, Page 75**).



### DANGER

#### Risk of death due to electrical shock and discharge!

De-energise device and secure against being switched on again.  **De-energising the inverter, Page 75**

2. Remove all DC cables and communication cables.
3. Open the inverter's AC terminal compartment.
4. Loosen terminals and cable glands.
5. Remove all AC cables.
6. Close the inverter cover.
7. Loosen locking screw on inverter's bracket.
8. Lift inverter off the wall.

### Proper disposal

Electronic equipment labelled with a dustbin with a line through it may not be disposed of with household waste. This equipment can be handed in to waste collection points free of charge.



Find out about the local requirements for the separate collection of electrical and electronic equipment in your country.

