

PLENTICORE plus

Hybrid inverter – G2



Operating manual

Legal notice

KOSTAL Solar Electric GmbH
Hanferstraße 6
79108 Freiburg i. Br.
Germany
Tel. +49 (0)761 477 44-100
Fax +49 (0)761 477 44-111

www.kostal-solar-electric.com

Exclusion of liability

All names, trademarks, product names and other designations used in this manual may be legally protected even if not indicated as such (e.g. as a trademark). assumes no liability for their free usage. The illustrations and texts have been compiled with great care. However, the possibility of errors cannot be ruled out. The compilation is made without any guarantee.

General note on gender equality

is aware of how language impacts on gender equality and always makes an effort to reflect this in documentation. Nevertheless, for the sake of readability we are unable to use non-gender-specific terms throughout and use the masculine form instead.

© 2023 KOSTAL Solar Electric GmbH

All rights reserved by , including those of reproduction by photocopy and storage in electronic media. Commercial use or distribution of the texts, models, diagrams and photographs appearing in this product is not permitted. This manual may not be reproduced, stored, transmitted or translated in any form or by means of any medium, in whole or in part, without prior written permission.

Valid from version:

Software (SW): 02.08.0xxxx



Contents

1.	General information.....	6
1.1	Contact	7
1.2	About this manual	8
1.3	Target group	9
1.4	Exclusion of liability	10
1.5	Open Source licence	11
1.6	Proper use	12
1.7	EU Declaration of Conformity.....	13
1.8	Notes in this manual	14
1.9	Important safety instructions.....	16
1.10	Navigation in the document	19
1.11	Labelling on the device	20
2.	Device and system description	21
2.1	System overview	22
2.2	The inverter	25
2.3	Functions	31
3.	Installation	45
3.1	Trip control signal connection at inverter.....	46
3.2	Transport and storage	47
3.3	Scope of delivery	48
3.4	Installation	49
3.5	Electrical connection.....	53
3.6	Overview of Smart Communication Board (SCB)	57
3.7	Energy meter connection.....	59
3.8	Connecting ripple control receiver	63
3.9	Connecting the signal contact for the external overvoltage protection (SPD – Surge Protective Device)	68
3.10	Connection of switched outputs	70
3.11	Communication connection	71
3.12	Connecting battery	74
3.13	Closing the inverter.....	78
3.14	Connecting battery's DC cables	79
3.15	Connecting solar module.....	81
3.16	Initial commissioning.....	85
3.17	Configuring settings in the Webserver.....	95
4.	Operation and operating the device.....	96

	1	2	3	4	5	6	7	8	9	10	11	12	13	14	15	
4.1	Switching on the inverter															97
4.2	Switching off the inverter															98
4.3	De-energising the inverter															99
4.4	When working on the DC feed cables.....															100
4.5	Control panel.....															101
4.6	Operational status (display).....															103
4.7	Operational status (LEDs)															107
4.8	Inverter menu structure.....															108
4.9	Description of inverter menus															116
5.	Connection types															126
5.1	Connecting the inverter/computer															127
5.2	Settings on the computer															128
5.3	Connecting the inverter/computer															129
5.4	Disconnecting the inverter from the computer															131
5.5	Connection via KOSTAL Solar App.....															132
6.	Webserver.....															133
6.1	The Webserver															134
6.2	Accessing the Webserver															137
6.3	Webserver – menu structure.....															139
6.4	Webserver– menus															144
7.	Switched outputs															169
7.1	Switched outputs at a glance															170
7.2	Connection for self-consumption control															173
7.3	Set up self-consumption control for load control.....															176
7.4	Set up self-consumption control for heat pumps (SG Ready).....															179
7.5	Set up self-consumption control for wallbox															181
7.6	Set up switched output for reporting events															183
7.7	Switched output via external control															185
8.	Overvoltage protection															186
8.1	Configure evaluation of external overvoltage protection in the Webserver															187
9.	Active power control															189
9.1	Why active power control?															190
9.2	Limitation of the PV feed-in capacity															191
9.3	Active power control with a ripple control receiver															192
9.4	Active power control using smart measuring systems.....															195
10.	External battery control															198
10.1	External battery control.....															199

10.2	External battery control via Modbus (TCP)	200
10.3	External battery control via digital inputs	202
11.	System monitoring	204
11.1	The log data	205
11.2	Retrieving, storing and graphically depicting log data.....	209
11.3	The KOSTAL Solar Portal	211
12.	Maintenance	212
12.1	Maintenance and cleaning	213
12.2	Housing cleaning	214
12.3	Fan cleaning	215
12.4	Updating software	219
12.5	Event codes	222
13.	Technical data	223
13.1	Technical data	224
13.2	Block diagram	228
14.	Accessories	229
14.1	KOSTAL Solar Portal	230
14.2	KOSTAL Solar App.....	231
14.3	KOSTAL Solar Plan configuration software	232
14.4	Activating battery connection.....	233
15.	Appendix.....	234
15.1	Type plate	235
15.2	Warranty and service	237
15.3	Handover to the operator	238
15.4	Decommissioning and disposal	239

1. General information

1.1	Contact.....	7
1.2	About this manual.....	8
1.3	Target group.....	9
1.4	Exclusion of liability	10
1.5	Open Source licence.....	11
1.6	Proper use	12
1.7	EU Declaration of Conformity	13
1.8	Notes in this manual.....	14
1.9	Important safety instructions	16
1.10	Navigation in the document.....	19
1.11	Labelling on the device.....	20



1.1 Contact

Thank you for choosing a device from KOSTAL Solar Electric GmbH.

If you have any technical questions, please call our service hotline:

- Germany and other countries (language: German, English):
+49 (0)761 477 44-222
- Switzerland:
+41 32 5800 225
- France, Belgium, Luxembourg:
+33 16138 4117
- Greece:
+30 2310 477 555
- Italy:
+39 011 97 82 420
- Poland:
+48 22 153 14 98
- Spain, Portugal (language: Spanish, English):
+34 961 824 927

Please have the following information to hand for speedy processing:

- Type designation
- Serial number (see type plate on the device)



1.2 About this manual

This manual is intended for the operator and electrician. It contains information relating to safe operation and installation. Activities that may only be carried out by an electrician are marked separately. Pay particular attention to the information regarding safe usage. assumes no liability for damages arising from non-observance of this manual.

This manual is an integral part of the product. It applies exclusively to the device from . Keep all documents permanently for reference and pass them on to any subsequent operator.

The electrician and operator must have unrestricted access to these instructions at all times. The installer must be familiar with this manual and follow all instructions.

The most recent version of the operating manual for the product is available in the download area at www.kostal-solar-electric.com.



1.3 Target group

This manual is intended for trained and qualified electricians who are entrusted with installing, maintaining and repairing the device.

The devices described in this manual differ from one another in terms of particular technical details. Information and instructions that only apply to certain device types are identified accordingly.

Information concerning your safety or that of the unit is specifically noted.

Operator

As the operator, you are responsible for the device. You are responsible for the proper use and safe use of the device. This also includes instructing people using the device.

As an operator without specialist electrical training, you may only carry out activities that do not require an electrician.

Electrician

As an electrician, you have recognised electrical engineering training. On the basis of this expertise, you are authorised to carry out the electrical work required in this manual.

Requirements of an electrician:

- Knowledge of general and specific safety and accident prevention regulations.
- Knowledge of electrical regulations.
- Knowledge of national regulations.
- Ability to recognise risks and avoid possible hazards.

Qualification

Some activities in this manual require expertise in electrical engineering. If activities are carried out by someone without the necessary knowledge and qualifications, serious accidents and death may result.

- Only carry out activities for which you have been qualified and instructed.
- Observe the references to electricians in this manual.



1.4 Exclusion of liability

Any use other than that described in  **Proper use, Page 12** or any use going beyond that is considered improper use. The manufacturer accepts no liability for any damage resulting from this. Modifications to the device are prohibited.

The device may only be used if it is safe to operate and is in a technically perfect condition. Any instance of misuse will result in the termination of the warranty, guarantee and general liability of the manufacturer.



IMPORTANT INFORMATION

The meter may only be installed, maintained and repaired by a trained and qualified electrician.

The electrician is responsible for ensuring that the applicable standards and regulations are observed and implemented. Work that could affect the electrical power system of the relevant energy supply company at the site of the solar power feed-in may only be carried out by qualified electricians expressly authorised (licensed) by the energy supply company.

This includes changes to the factory-preset parameters.

Only a qualified electrician may open the device. The device must be installed by a trained electrician (according to DIN VDE 1000-10 or BGV A3 accident prevention regulations or an internationally comparable standard) who is responsible for observing the applicable standards and regulations.

Work that could affect the electrical power system of the relevant energy supply company at the site of the solar power feed-in may only be carried out by qualified electricians expressly authorised (licensed) by the energy supply company. This includes changes to the factory-preset parameters. The installer must always observe the regulations of the energy supply company.

Factory settings may only be changed by qualified electrical installers or persons with at least comparable or higher technical qualifications, e.g. trades professionals, technicians or engineers. When doing so, all requirements are to be observed.



1

2

3

4

5

6

7

8

9

10

11

12

13

14

15

1.5 Open Source licence

This product contains Open Source software, developed by third parties and licensed using vehicles including GPL and/or LGPL.

For more details on this and a list of the Open Source software used and the associated licence texts, go to the Licences section on the website (Webserver) under **Licences**.



1.6 Proper use

The inverter converts direct current into alternating current. This can be used as follows:

- For self-consumption
- For feed-in into the public grid
- For temporary storage in a battery storage system



INFO

For battery storage to be connected to the inverter, DC input 3 must be released for battery use. To do this, an activation code must be entered in the inverter. The activation code can be purchased at KOSTAL Solar Webshop [☑ Activating battery connection, Page 233](#)

The device may only be used in grid-connected systems within the intended power range and under the permissible ambient conditions. The device is not intended for mobile use.

Inappropriate use may lead to injury or even death for the user or third parties. Material damage to the device and other equipment can also occur. The device may therefore only be used for its intended purpose.

All components fitted on the device or in the system must satisfy the standards and guidelines that apply in the country of installation.



INFO

Please observe the following instructions on connecting an energy meter:

Using original accessories and spare parts as well as approved energy meters is permitted for energy meters. KOSTAL accepts no liability and provides no support for any damage caused by non-certified/unapproved products.

The inverter may only be used together with battery systems that have been approved by KOSTAL Solar Electric GmbH for this type of inverter.



1.7 EU Declaration of Conformity

KOSTAL Solar Electric GmbH hereby declares that the devices described in this document complies with the basic requirements and other relevant conditions of the directives listed below.

- Directive 2011/65/EU (RoHS) to limit the use of certain hazardous substances in electrical and electronic equipment
- Directive 2014/53/EU (RED Radio Equipment and Telecommunications Terminal Equipment) Provision of radio equipment

You will find a detailed EU Declaration of Conformity for the product in the download area at:

www.kostal-solar-electric.com



1

2

3

4

5

6

7

8

9

10

11

12

13

14

15

1.8 Notes in this manual

A distinction is made in this manual between warnings and information notes. All notes are identified in the text line with an icon.

Warnings

The warnings refer to life-threatening dangers. Serious injuries possibly resulting in death may occur.



DANGER

Indicates a direct hazard with a high level of risk, which, if not avoided, will result in death or serious injury.



WARNING

Indicates a hazard with a moderate level of risk, which, if not avoided, will result in death or serious injury.



CAUTION

Indicates a hazard with a low level of risk, which, if not avoided, will result in minor or slight injury or property damage.



IMPORTANT INFORMATION

Indicates a hazard with a low level of risk, which, if not avoided, may result in damage to property.



INFO

Information notes contain important instructions for the installation and problem-free operation of the device. These must be followed at all times. The information notes also point out that failure to observe instructions may result in damage to property or financial damages.

Warning symbols



Danger



1

2

3

4

5

6

7

8

9

10

11

12

13

14

15



Danger due to electrical shock and discharge



Danger due to burns

Symbols within the information notes



The symbol indicates activities that may only be carried out by an electrician.



Information or tip



Important information



Damage to property possible



1.9 Important safety instructions

The safety instructions in this manual must be observed during all work on the device.

The product has been developed and tested in accordance with international safety requirements. Nevertheless, there are still risks, which may result in personal injury and damage to property. Therefore, pay particular attention to the safety instructions in this chapter to avoid these risks at all times.



DANGER

Risk of death due to electrical shock and discharge

During operation, high voltages are present on the live parts and cables inside the product. Touching live parts or cables will result in death or life-threatening injuries from electrical shock.

- Before opening the device, de-energise it and secure it against being switched on again.



DANGER

Risk of death due to electrical shock and discharge!

During operation, high voltages are present on the live parts and cables inside the product. Touching live parts or cables will result in death or life-threatening injuries from electrical shock.

- De-energise inverter and battery storage. Please also observe the instructions in the operating manual provided by the battery manufacturer.



DANGER

Danger to life from electrical shock when touching live DC cables

When exposed to light, the PV modules generate a high DC voltage that is applied to the DC cables. Touching live DC cables will result in death or life-threatening injuries from electrical shock.

- Do not touch any exposed live parts or cables.
- Before working, de-energise the device and secure it against being switched on again.
- Wear suitable protective equipment during all work on the product.

**DANGER****Risk of death due to electrical shock and discharge!**

The battery's DC cables may be energised.

- Be sure to de-energise the battery storage system. Please also observe the instructions in the operating manual provided by the battery manufacturer.

**CAUTION****Danger of burns from hot housing parts**

Housing parts can become hot during operation. Touching hot housing parts can cause burns.

- During operation, only touch the inverter's housing cover.

**CAUTION****Risk of fire due to overcurrent and heating of the mains cable**

If mains cables are too small, they can heat up and cause a fire.

- Use a suitable cross-section
- Install line circuit breaker to secure against overcurrent.

**POSSIBLE DAMAGE****Damage to the device**

Potential risk of damage when setting the inverter down. Whenever possible, place the inverter on its back after unpacking.

**IMPORTANT INFORMATION****Loss of warranty due to incorrect installation**

Observe these instructions when selecting the installation site. Failure to observe these instructions may limit guarantee claims or render them fully null and void.

- Be absolutely sure to maintain the clearance around the inverter in order that the inverter remains cool.
- To mount the inverter, use the wall mount and fastening screws that are suitable for the substrate.



IMPORTANT INFORMATION

Damage to the device and loss of warranty due to installation by unqualified persons

The inverter may only be installed, maintained and repaired by a trained and qualified electrician.

The electrician is responsible for ensuring that the applicable standards and regulations are observed and implemented.

Work that could affect the electrical power system of the relevant energy supply company at the site of the solar power feed-in may only be carried out by qualified electricians expressly authorised (licensed) by the energy supply company.

This includes changes to the factory-preset parameters.



IMPORTANT INFORMATION

Nature and source of hazard

A type A RCD ≥ 300 mA can be used on the AC side as a residual current device (RCD). Set the compatibility with a type A RCD in the Webserver.



1.10 Navigation in the document

To simplify navigation through this document, it contains clickable areas.







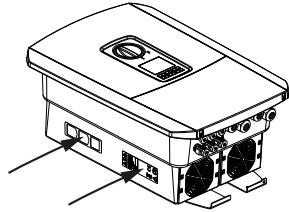

The table of contents takes you to the specified chapter in one click.

You can navigate to the referenced points in the document within the instruction text using the cross-references.

1.11 Labelling on the device



Signs and labels are applied to the housing of the inverter. These signs and labels may not be altered or removed.

Symbol	Explanation
	Danger due to electrical shock and discharge
	Danger due to burns
	Danger notice
	Danger due to electrical shock and discharge. Wait five minutes (discharge time of the capacitors) after shutdown
	Additional earth connection
	Observe and read operating manual
	Device may not be disposed of with household waste. Observe the local application of disposal requirements.
	CE marking The product satisfies the applicable EU requirements.



2. Device and system description

2.1	System overview	22
2.2	The inverter	25
2.3	Functions	31

2.1 System overview

PLENTICORE plus G2 with 3 PV inputs

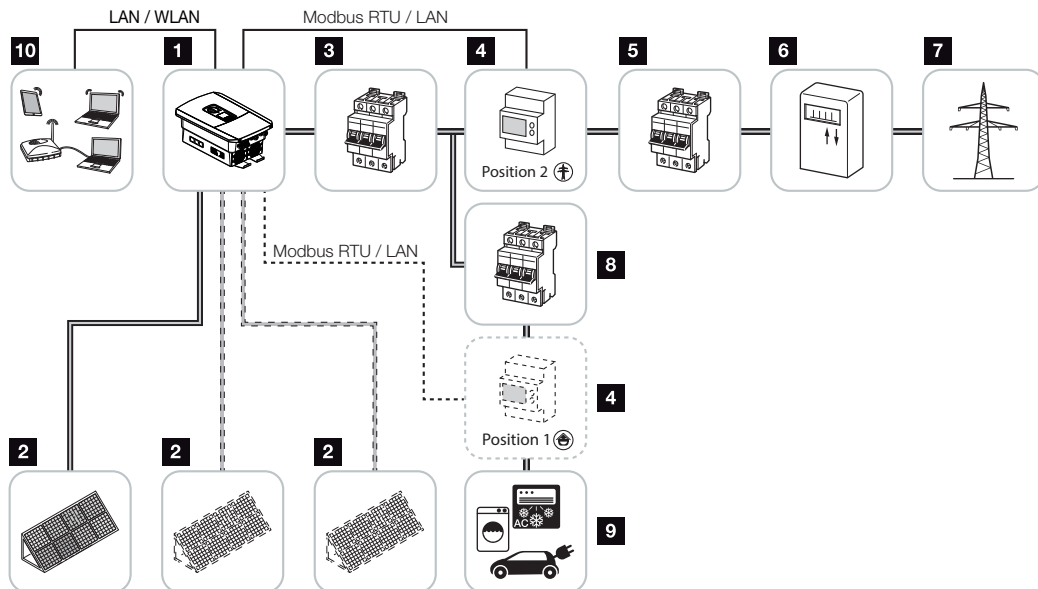

- 1 Inverter
- 2 PV generators (number depends on the type)
- 3 Line circuit breaker for inverter
- 4 Digital energy meter (Modbus RTU)
Home consumption (position 1) or grid connection (position 2). Position 2 should be prioritised.
- 5 Main fuse for building
- 6 Feed-in procurement meter or smart meter (not in all countries)
- 7 Public grid
- 8 Line circuit breaker for energy consumers
- 9 Energy consumers
- 10 Communication link for inverter



1

2

3

4

5

6

7

8

9

10

11

12

13

14

15

PLENTICORE plus G2 with 2 PV inputs and 1 DC battery connection

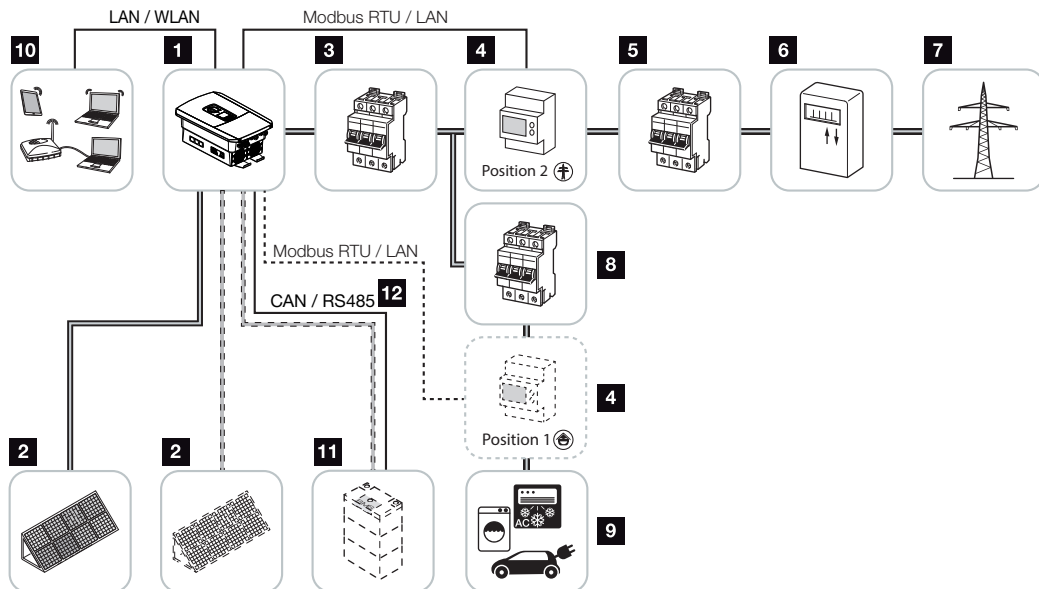

- 1 Inverter
- 2 PV generators (number depends on the type)
- 3 Line circuit breaker for inverter
- 4 Digital energy meter (Modbus RTU)
Home consumption (position 1) or grid connection (position 2). Position 2 should be prioritised.
- 5 Main fuse for building
- 6 Procurement and feed meter or smart meter (not in all countries)
- 7 Public grid
- 8 Line circuit breaker for energy consumers
- 9 Energy consumers
- 10 Communication link for inverter
- 11 Connection for battery system (available as option after activation)
- 12 Battery Management System (BMS) communication link via CAN or RS485 (depending on battery system)



1

2

3

4

5

6

7

8

9

10

11

12

13

14

15

PLENTICORE plus G2 with additional AC energy supplier

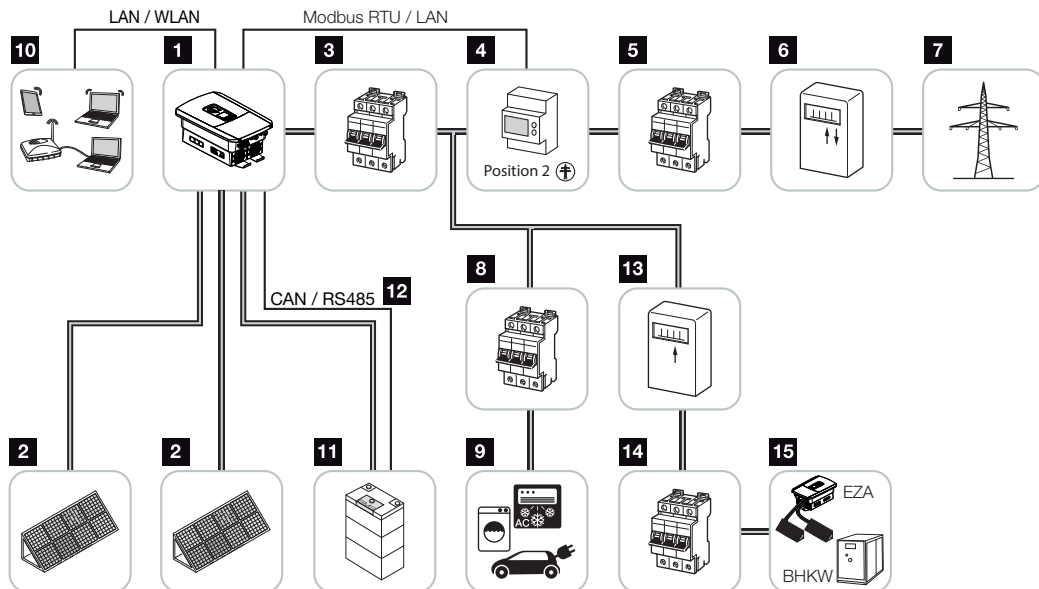

- 1 Inverter
- 2 PV generators (number depends on the type)
- 3 Line circuit breaker for inverter
- 4 Digital energy meter (Modbus RTU)
- 5 Main fuse for building
- 6 Procurement and feed meter or smart meter (not in all countries)
- 7 Public grid
- 8 Line circuit breaker for power consumption
- 9 Power consumption
- 10 Communication link for inverter
- 11 Connection for battery system (available as option after activation)
- 12 Battery Management System (BMS) communication link via CAN or RS485 (depending on battery system)
- 13 Feed meter for AC power source
- 14 Line circuit breaker for AC power source
- 15 AC power source, e.g. CHP unit, or other generation plants, such as PV inverter (the energy from the AC power source can be temporarily stored in the battery)



1

2

3

4

5

6

7

8

9

10

11

12

13

14

15

2.2 The inverter

The device from the outside

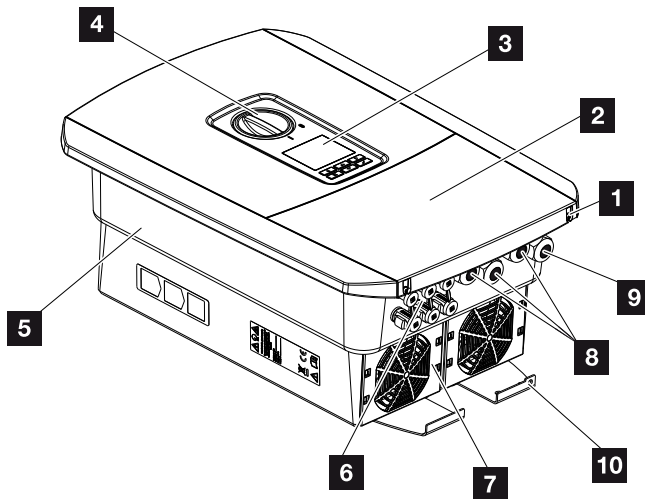

- 1 Cover screws
- 2 Cover (terminal compartment)
- 3 Display
- 4 DC switch
- 5 Housing
- 6 Plug connectors for connecting the PV generators and battery system (battery connection only available after activation)
- 7 Fan
- 8 Cable openings for communication
- 9 Cable opening for mains cable
- 10 Additional PE connection, outside



1

2

3

4

5

6

7

8

9

10

11

12

13

14

15

DC switch on the inverter

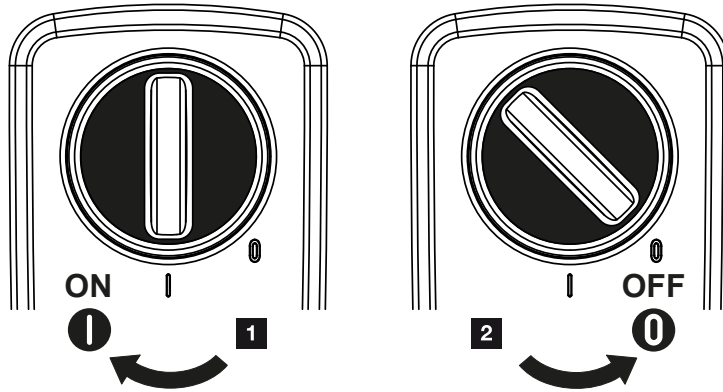

1 Switch on inverter

2 Switch off inverter



1

2

3

4

5

6

7

8

9

10

11

12

13

14

15

The terminal compartment

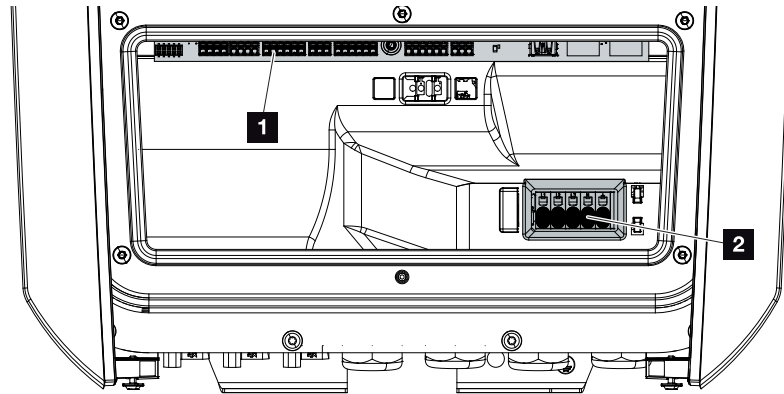

- 1 Smart Communication Board (SCB)
- 2 AC terminal

Smart Communication Board (SCB)

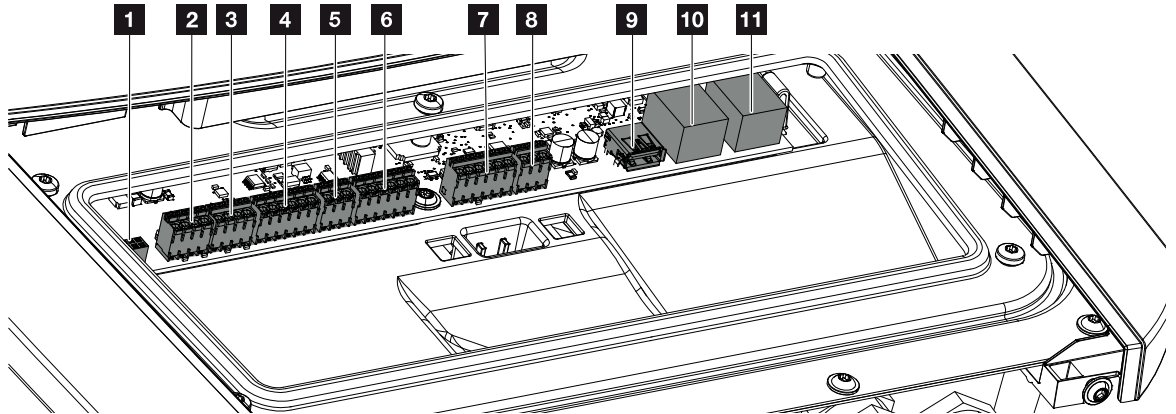

1	X603	Not used.
2	X1401	Potential-free switched outputs OUT 1 and OUT 2 (NO or NC contact) Loadable up to max. 24 V, 100 mA (ext. power supply unit required for supply).
3	X1402	Potential-free switched outputs OUT 3 and OUT 4 (NO or NC contact) Loadable up to max. 24 V, 100 mA (ext. power supply unit required for supply).
4	X401	Terminal for digital interface for ripple control receiver/external battery control
5	X403	Terminal for ripple control receiver CEI for Italy.
6	X601	Battery communication terminal.
7	X402	SPD monitor input connection (evaluating external overvoltage protection).
8	X452	Terminal for communication with the energy meter (KOSTAL Smart Energy Meter) via RS485.
9	X171	USB connection (5 V, 500 mA). For service purposes only.
10	X207	Ethernet connection (RJ45) LAN.
11	X206	Ethernet connection (RJ45) LAN.

The Smart Communication Board (SCB) is the communication and interface centre. All the connections for communicating with other components can be found on the SCB.



1

2

3

4

5

6

7

8

9

10

11

12

13

14

15

The control panel

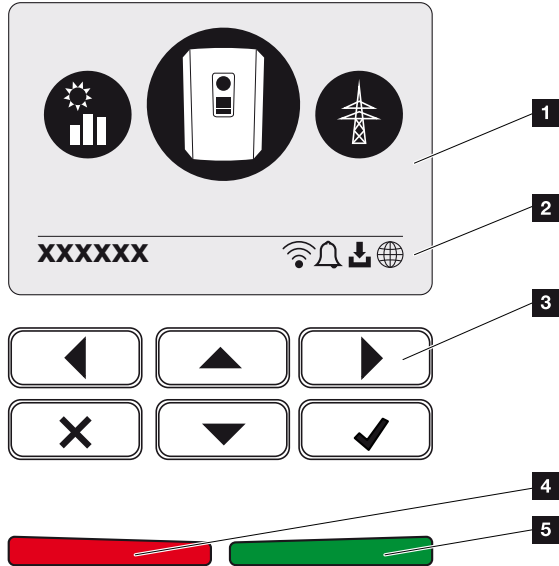

- 1 Display
- 2 Status line alternating (inverter status, event code, IP address, WLAN status, solar portal connection, software update available, events)
- 3 Control buttons
- 4 Red status LED for events
- 5 Green status LED for feed-in mode

Settings can be configured and data retrieved via the control panel.



1

2

3

4

5

6

7

8

9

10

11

12

13

14





15

The inverter menus

The inverter provides the following menu items for querying statuses and configuring the inverter:

INFO

There may be deviations depending on the software version.

Symbol	Function
	PV power status query
	AC feed-in capacity status query and public grid parameter
	House consumption status query
	Battery power status query
	Inverter configuration

2.3 Functions

Energy management system

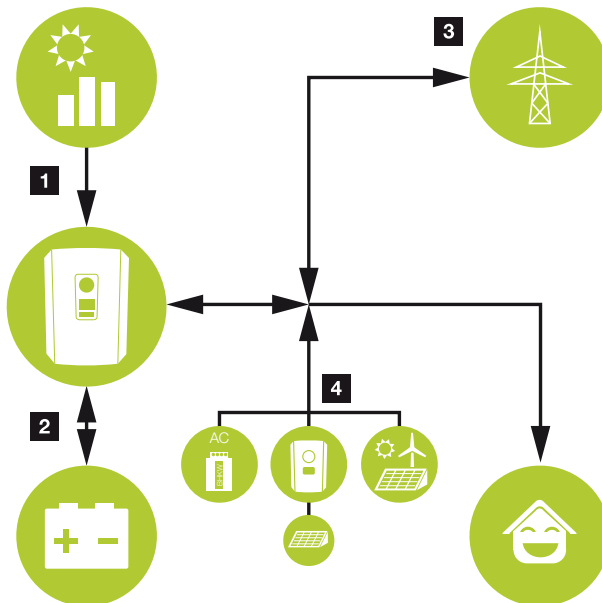

i INFO

AC power sources can be, for example, KOSTAL solar inverters, other inverters, combined heat and power (CHP) units, small wind turbines or other energy sources in your own house grid.

In order to store this energy in a connected battery, this function must be activated in the Webserver. **Webserver menu – Service menu – General, Page 156**

1 **PV energy:**

- For use by local consumers
- For charging the battery
- For feeding into the public grid

2 **Battery energy:**

- For use by local consumers
- For feeding into the public grid (only possible via external battery manager)

3 **Grid energy:**

- For use by local consumers
- For charging the battery from the public grid, e.g. to protect the battery in winter or via external battery control/battery manager.



1

2

3

4

5

6

7

8

9

10

11

12

13

14

15

4 AC power sources:

- For use by local consumers
- For charging the battery
- For feeding into the public grid

The energy management system (EMS) controls the distribution of energy between the DC side (PV generator) and the AC side (house grid, public grid). For this purpose, the EMS checks for consumption in the internal house grid. The logic of the EMS then calculates and controls the optimal usage of PV energy. Priority is given to use by self-consumers of the PV energy generated. The remaining generated PV energy is fed into the grid and remunerated.



1

2

3

4

5

6

7

8

9

10

11

12

13

14

15

Recording home consumption

INFO

In order for the home consumption to be displayed, a compatible energy meter must be installed in the house network.

Connecting up an external energy meter (via Modbus RTU) enables the inverter to monitor and optimally control the flow of energy in the home for 24 hours.

The PV energy generated is primarily used for consumers (such as lights, the washing machine or television).

The energy generated above and beyond this can be stored temporarily in a battery storage device or fed into the public grid.

INFO

For battery storage to be connected to the inverter, DC input 3 must be released for battery use. To do this, an activation code must be entered in the inverter. The activation code can be purchased from the KOSTAL Solar online shop.  **Activating battery connection, Page 233**

For more information  **Energy meter connection, Page 59**

- Using energy meter (Modbus RTU) to record home consumption
- 24-hour measurement
- Various types of energy meter can be used

INFO

You will find a list of **approved energy meters** and their purpose in the download area for the product on our website at <https://www.kostal-solar-electric.com>

INFO

Please observe the following instructions on connecting an energy meter:

Using original accessories and spare parts as well as approved energy meters is permitted for energy meters. KOSTAL accepts no liability and provides no support for any damage caused by non-certified/unapproved products.



1

2

3

4

5

6

7

8

9

10

11

12

13

14

15

Storing energy

If external battery storage is connected to DC input 3 on the inverter (can be released using the battery activation code), the PV energy generated can be stored and accessed later on for self-consumption.

- The connection and battery use at the DC input 3 on the inverter must be released beforehand in the inverter. To do this, the battery activation code can be purchased from the KOSTAL Solar online shop.
- You will find a list of approved KOSTAL Solar Electric battery storage systems on our website in the download area for the product.
- Using the smart generation and consumption forecast allows usage of the generated energy to be optimised (in addition to simply storing power) and all power limitations stipulated by law are fulfilled at the same time.



1

2

3

4

5

6

7

8

9

10

11

12

13

14

15

Shadow management

If a connected PV string is subjected to partial shading, caused, for example, by other parts of a building, trees or power lines, the entire PV string no longer achieves its optimum performance. The PV modules affected behave like a bottleneck and thereby prevent the string in question from performing better.

The intelligent shadow management integrated in the inverter now adapts the MPP tracker of the selected string so that the PV string can always deliver optimum performance in spite of partial shading.

Shadow management can be activated via the Webserver for each string.  **Webserver menu – Service menu – General, Page 155**



Communication

The inverter provides various interfaces for communication purposes. These establish a connection to other inverters, sensors, energy meters, batteries or a link to the Internet.

■ LAN

LAN connects the inverter to the local home network, through which it can then access the Internet and solar portal. In addition, there is a second LAN interface on the inverter's communication board to which another device (e.g. inverter) can be connected.

■ Wifi

Via Wifi, the inverter can be connected to a Wifi router located in the local home network, giving it access to the Internet and the solar portal.

■ Wifi access point

The inverter offers a Wifi access point for initial commissioning. This can then be used to connect to a smartphone or PC and carry out the initial commissioning via the web-based installation wizard.

■ RS485/Modbus (RTU)

Energy meters are connected to the Modbus interface and record the flow of energy within the house.

Secure communication

These days, secure data transfer is an important element of all devices linked to the Internet. All the data transferred externally from the inverter is of course encrypted for this reason.

■ Security concept

Encrypted transfer of data to the solar portal

■ Data encryption in line with AES and SSL standards



1

2

3

4

5

6

7

8

9

10

11

12

13

14

15

Ripple control receiver/smart meter

Once the system reaches a certain size, which may vary from one country to the next, the use of a ripple control receiver is mandatory. In some instances, the energy provider also requires a smart meter to be installed.

Contact your energy provider for more information.

If a smart meter gateway is fitted in your house installation, the inverter can be connected to the smart meter gateway using a control box. The control box is connected to the inverter like a ripple control receiver.

- Connection facility for ripple control receivers
- Connection facility for a control box for communicating with a smart meter gateway

For more information, see [☑ Active power control, Page 189](#)

Self-consumption control

To make the best possible use of the PV energy generated, self-consumption should be prioritised. To do this, the inverter allows consumers to be connected to it via an external relay. The consumers can then be switched on when there is sufficient PV power and thereby access the PV energy generated at that point in time.

For more information, see [☑ Switched outputs, Page 169](#).



1

2

3

4

5

6

7

8

9

10

11

12

13

14

15

External battery control

The inverter has a charge/discharge management system that can be configured via the Webserver under **Service menu > Battery settings**. Among other things, the **external battery control** can be activated here, which then implements the specifications of your energy supplier or other service provider, for example.

Via the external battery management, the external supplier has access to the charge/discharge management of the inverter and can control it in such a way that the battery energy can be used e.g. for home consumption or that the battery energy is fed into the public grid in order to use it e.g. for grid stabilisation (load peaks in the grid (peak shaving)) or to provide grid services (primary control power).



INFO

The system installer is responsible for the correct selection and installation of the meter structure in the house grid. The specifications of the energy supplier must be observed in this case.

The system owner is responsible for correctly using/selecting the internal or external charge/discharge management.



1

2

3

4

5

6

7

8

9

10

11

12

13

14

15

The Webserver

The Webserver is the graphic interface (displayed in the browser, e.g. Firefox, Microsoft Edge or Google Chrome) for querying and configuring the inverter.

The Webserver provides the following functions:

- Logging in to the device
- Querying the status
- Current power values for the PV generators
- Present consumption values
- Current values of grid connection (e.g. feed-in, consumption)
- Statistics
- Using the self-consumption terminal
- Displaying log data
- Displaying current version (e.g. software, firmware, hardware)
- Configuring the device
(e.g. software update, enabling options, battery configuration, network settings, activating solar portal, implementing settings specified by the energy supplier, etc.)

For more information, see  **Webserver, Page 133.**



1

2

3

4

5

6

7

8

9

10

11

12

13

14

15

The data logger

A data logger is integrated in the inverter. The data logger is a data storage system, which collects and stores the yield and performance data of the inverter and the storage system. Yield data is saved every 5 minutes.



INFO

Once the storage time has elapsed, the oldest data is always deleted.

For long-term backup, the data must be backed up with a PC or sent to a solar portal.

Saving interval	Storage time
5 minutes	Max. 365 days

For more information, see [☑ System monitoring, Page 204](#).



1

2

3

4

5

6

7

8

9

10

11

12

13

14

15

Event codes

Should an event or fault occur during operation, it is indicated on the inverter display and on the Webserver and is stored in the inverter and solar portal (only if connected).

For more information, see [📄 Event codes, Page 222](#).

Service concept

The inverter includes smart monitoring. Should an event occur during operation, an event code for this is shown on the display and on the Webserver.

As the operator of the system, in the event of a service call-out, you can then read out the message and obtain assistance from your installer or service partner.



1

2

3

4

5

6

7

8

9

10

11

12

13

14

15

KOSTAL Solar Portal

The KOSTAL Solar Portal allows operation of the inverters to be monitored via the Internet. This protects your investment in a PV system against yield losses, e.g. through active e-mail alerts if events occur.

Registering for the KOSTAL Solar Portal is free of charge at www.kostal-solar-portal.com.

Functions include:

- Worldwide online access to the portal
- Graphic representation of the power and yield data
- Visualisation of data and thus being made aware of how to optimise self-consumption
- Notification of events by e-mail
- Data export
- Sensor evaluation
- Display and proof of a potential active power reduction by the grid operator
- Storage of log data for long-term and reliable monitoring of your PV system
- Providing system data for the KOSTAL Solar App

Additional information about this product is available on our website

www.kostal-solar-electric.com under **Products > Monitoring software > KOSTAL Solar Portal**.





1

2

3

4

5

6

7

8

9

10

11

12

13

14

15

KOSTAL Solar App

The free KOSTAL Solar App offers you professional monitoring of your photovoltaic system. You can use the KOSTAL Solar App to simply and easily access all functions on your smartphone or tablet at any time.

To set up and use the app, you will need access to the KOSTAL Solar Portal and to have an inverter set up there. To log in to the app, you will need to use the same access data as for the KOSTAL Solar Portal.

You can use the KOSTAL Solar App to easily monitor your photovoltaic system and to display relevant system data both at home and when you are out and about. It allows you to access the consumption and generation data over various time periods, such as day, week, month and year, and to view your photovoltaic system's historical data. This means that with the KOSTAL Solar App you are always up to date.

Download the free KOSTAL Solar App today and benefit from new and advanced functionalities.

Additional information about this product is available on our website

www.kostal-solar-electric.com under **Products > Monitoring software > KOSTAL Solar App**.



KOSTAL Solar App





KOSTAL Solar Plan configuration software

Our free KOSTAL Solar Plan software simplifies the inverter layout process.

Just enter the system data and individual customer data and receive a recommendation for a KOSTAL solar inverter tailored to the planned solar system. All KOSTAL solar inverters are considered for this. In addition, the customer's electricity consumption is considered and the possible self-consumption and potential self-sufficiency quotas are displayed using standard load profiles.

Self-consumption and potential self-sufficiency are displayed.

The KOSTAL Solar Plan covers the following areas of the inverter layout:

- **Rapid layout**

Manual inverter layout taking account of the inverter specifications

- **Layout**

Automatic PV inverter layout with possible consideration of power consumption.

- **Storage layout**

Automatic hybrid/storage inverter layout with possible consideration of power consumption.

As well as providing an improved inverter layout, the KOSTAL Solar Plan also supports preparing quotations. Customer, project and installer data is added to the technical data entered by the user and is included with the quotation as a PDF overview. The planning data can also be saved in a project file and edited if required.

You can find additional information about this product on our website

www.kostal-solar-electric.com in the section *Installer portal*.





3. Installation

3.1	Trip control signal connection at inverter	46
3.2	Transport and storage.....	47
3.3	Scope of delivery	48
3.4	Installation.....	49
3.5	Electrical connection	53
3.6	Overview of Smart Communication Board (SCB).....	57
3.7	Energy meter connection	59
3.8	Connecting ripple control receiver	63
3.9	Connecting the signal contact for the external overvoltage protection (SPD – Surge Protective Device).....	68
3.10	Connection of switched outputs.....	70
3.11	Communication connection	71
3.12	Connecting battery	74
3.13	Closing the inverter	78
3.14	Connecting battery's DC cables.....	79
3.15	Connecting solar module	81
3.16	Initial commissioning	85
3.17	Configuring settings in the Webserver	95



1

2

3

4

5

6

7

8

9

10

11

12

13

14

15

3.1 Trip control signal connection at inverter

If the inverter is to be controlled by the energy supplier via an external trip control signal, this is connected to the inverter as follows. No further settings are required in the inverter's Webserver for this function.

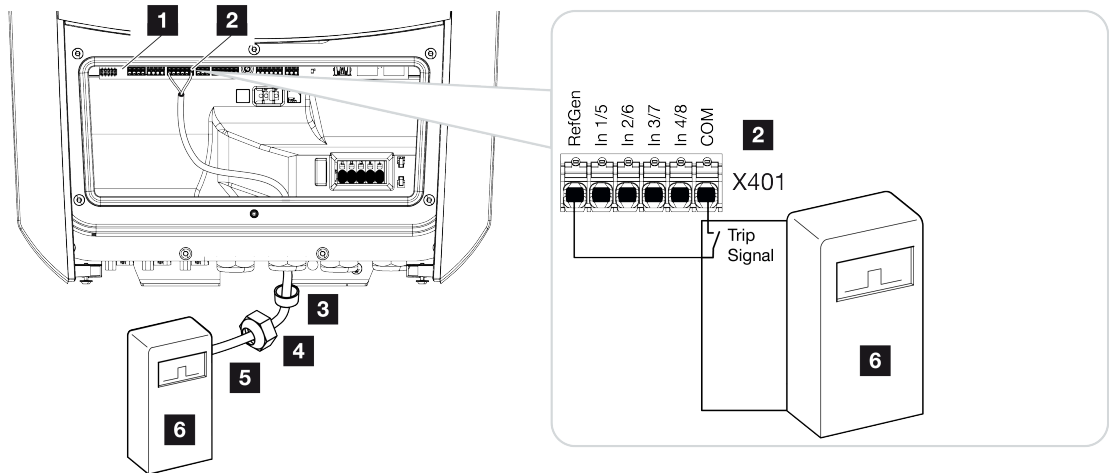

- 1 Smart Communication Board
- 2 Terminal
- 3 Sealing ring
- 4 Union nut
- 5 Control line
- 6 Ripple control receiver from the energy supply company with trip signal



1

2

3

4

5

6

7

8

9

10

11

12

13

14

15

3.2 Transport and storage

The function of the inverter has been tested and it has been carefully packaged prior to delivery. Upon receipt, check the delivery for completeness and any transport damage.



POSSIBLE DAMAGE

Potential risk of damage when setting the inverter down. Whenever possible, place the inverter on its back after unpacking.

Complaints and damage claims are to be directly addressed to the shipping company. If stored for a longer period before installation, all inverter components must be kept dry and dust-free in the original packaging.

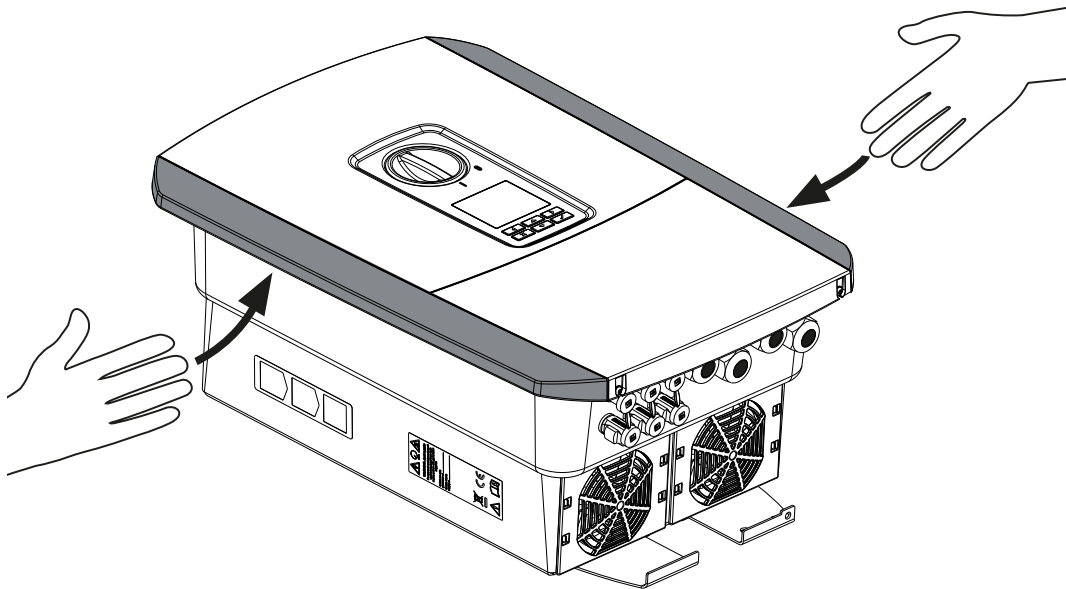

For enhanced inverter transport, use the grip strips on the left and right side of the inverter.



1

2

3

4

5

6

7

8

9

10

11

12

13

14

15

3.3 Scope of delivery

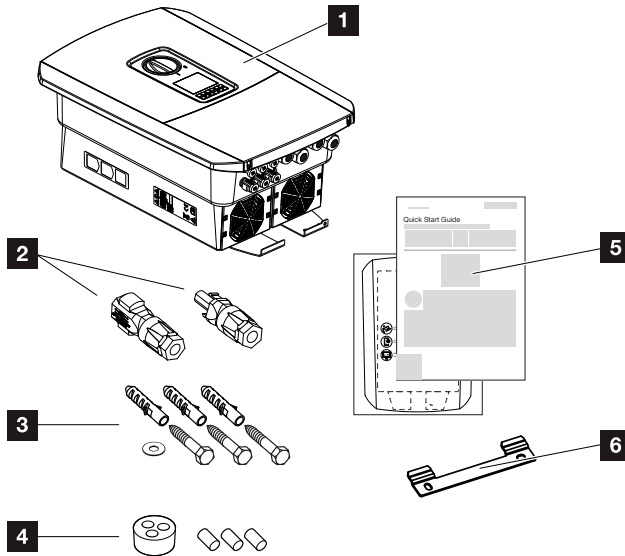

- 1 Inverter
- 2 DC plug connector (each DC input: 1× plug, 1× socket)
- 3 3× screws 6×50 with screw anchor S8 and 1× washer
- 4 Plug seals for the cable gland of the network and signal cables
- 5 Short manual and drilling template
- 6 Wall mount



1

2

3

4

5

6

7

8

9

10

11

12

13

14

15

3.4 Installation

Selecting the installation site.



IMPORTANT INFORMATION

Loss of warranty due to incorrect installation

Observe these instructions when selecting the installation site. Failure to observe these instructions may limit guarantee claims or render them fully null and void.

- Be absolutely sure to maintain the clearance around the inverter in order that the inverter remains cool.
- To mount the inverter, use the wall mount and fastening screws that are suitable for the substrate.



Protect inverter against exposure to direct sunlight.



Protect inverter from rain and splash water.



Protect inverter from falling parts which could enter the inverter's ventilation openings.

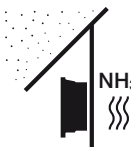

Protect the inverter against dust, contamination and ammonia gases. Rooms and areas containing livestock are not permitted as installation sites.



Mount inverter on a stable installation surface that can safely bear the weight. Plasterboard walls and wood planking are not permitted.



Mount inverter on a non-flammable installation surface.

WARNING! Some of the inverter components can reach temperatures of over 80 °C during operation. Select the installation site in accordance with the information provided in these instructions. Always keep the ventilation openings clear.



1

2

3

4

5

6

7

8

9

10

11

12

13

14

15

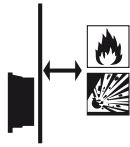

A sufficient safety distance from flammable materials and potentially explosive areas in the vicinity must be ensured.



Inverters can cause noise when in operation. Install inverter in such a way that people are not disturbed by operation noises.

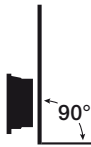

Mount inverters on vertical installation surfaces.

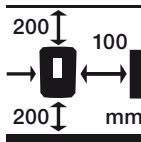

Maintain minimum distances and the necessary clearance.

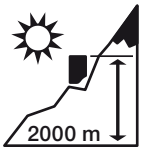

Inverter may only be installed up to an altitude of 2000 m.



The ambient temperature must be between -20 °C and +60 °C.



The air humidity must be between 4% and 100% (condensing).

4...100 %



Install inverters so that they are not accessible to children.



Inverters must be easily accessible and the display clearly legible.



Wifi installation site

The inverter can also be connected to the internet via Wifi instead of LAN. Make sure that there is also a good connection to the Wifi router at the installation site. Changing the installation location at a later date involves a lot of effort. The range is approx. 20-30 m. Walls reduce the range considerably.

The following points should be noted:

- Check in advance, e.g. with your mobile device, whether there is sufficient Wifi reception at the installation site.
- Measure the field strength. This should be as high as possible.
- If necessary, use repeaters to improve Wifi reception at the installation site.

Wall mounting

! IMPORTANT INFORMATION

Be absolutely sure to maintain the clearance around the inverter in order that the inverter remains cool.

! IMPORTANT INFORMATION

To install the inverter, use the wall mount with two retaining bolts (included in scope of delivery) that are suitable for the substrate. Fix the inverter to the wall at the bottom using a third bolt and washer (included in scope of delivery).

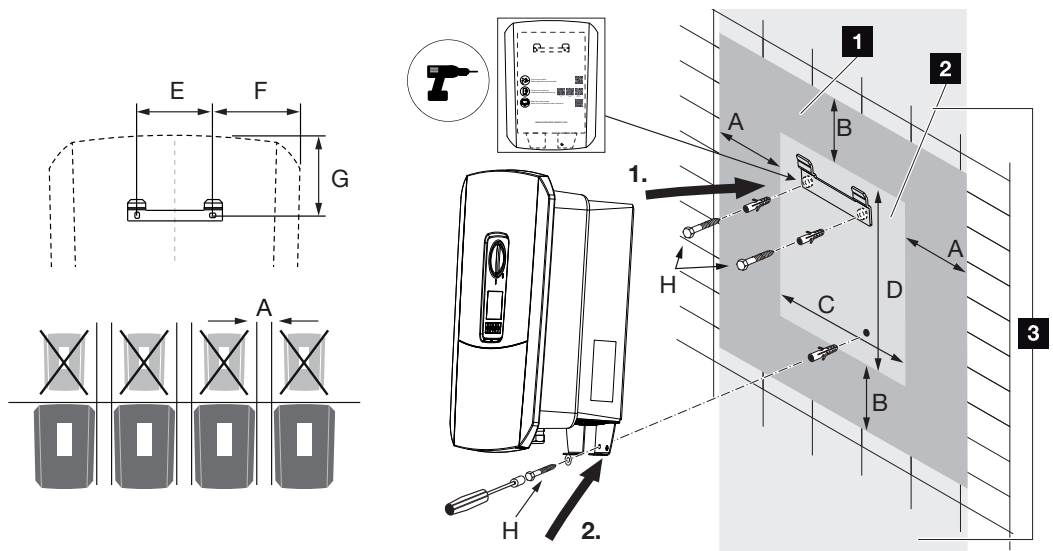

- 1 Clearance
- 2 Outer dimensions of the inverter
- 3 No other inverters may be mounted above or below the inverter.

The necessary dimensions for wall mounting and distances can be found in the table below. Use the drilling template supplied:

Dimensions in mm							
A	B	C	D	E	F	G	H
100	200	406	563	122	141	128	min. DIN571 A2-70 6x50



1

2

3

4

5

6

7

8

9

10

11

12

13

14

15

3.5 Electrical connection

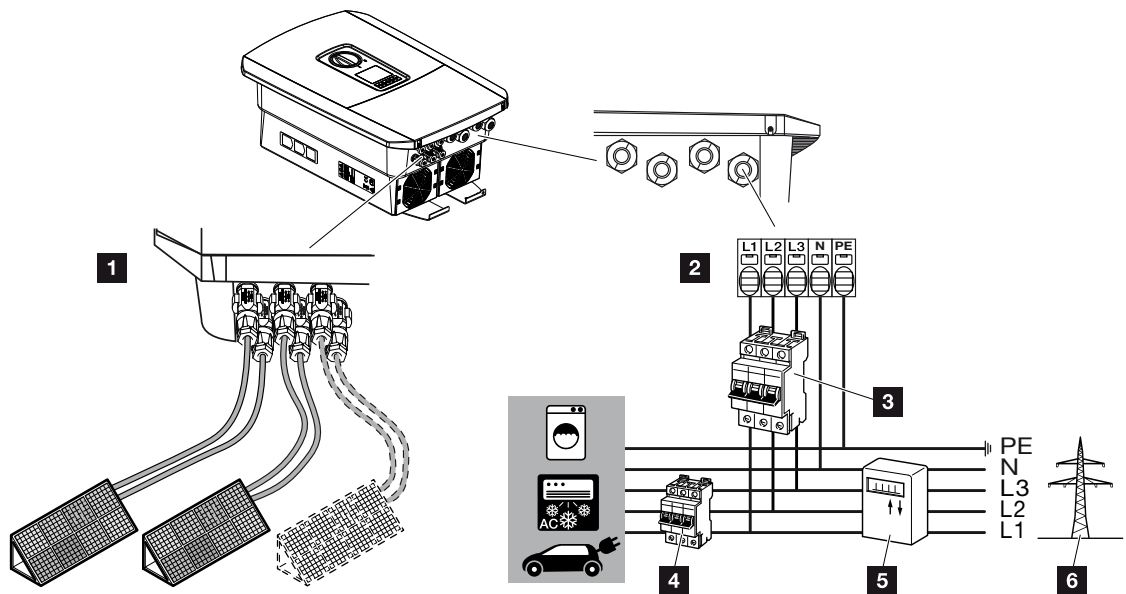

IMPORTANT INFORMATION

A type A RCD ≥ 300 mA can be used on the AC side as a residual current device (RCD). Compatibility with a type A RCD is set in the Webserver by going to **Service menu** > **External hardware settings** > **Residual current protection equipment**. (Default setting: compatible with type A RCD.)

1 Inverter connections: DC connections

2 Inverter connections: AC terminal

NOTE! Ensure that the phases of the AC terminal and the phases in the house grid are assigned uniformly.

3 External connections: Line circuit breaker for inverter

4 External connections: Line circuit breaker for consumers

5 External connections: Energy meter

6 External connections: Public grid



Connecting the mains cable

1. De-energise the house grid.



DANGER

Risk of death due to electrical shock and discharge!

De-energise device and secure against being switched on again. **De-energising the inverter, Page 99**

2. Secure home fuses against reactivation.
3. Switch the DC switch on the inverter to **OFF**.
4. Remove screws on the bottom cover and take off the cover.



IMPORTANT INFORMATION

Whenever working inside the inverter, only ever use insulated tools to prevent short-circuits.

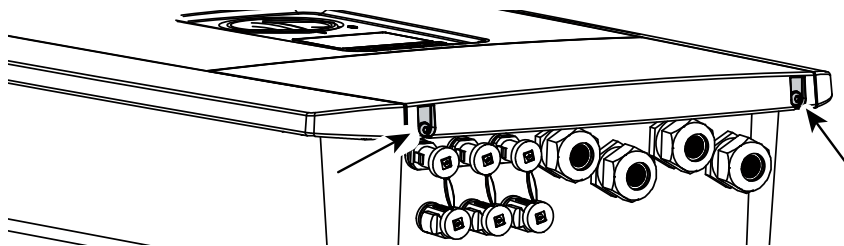

5. Remove screws of terminal compartment and take off cover.

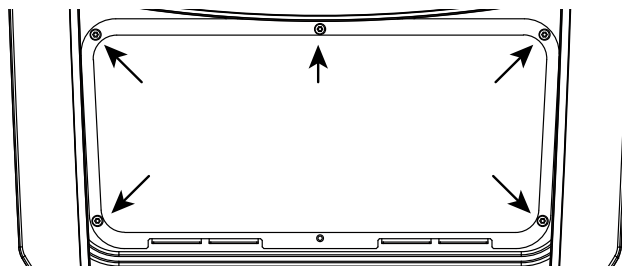

6. Correctly lay the mains cable from the power distributor to the inverter.



1

2

3

4

5

6

7

8

9

10

11

12

13

14

15

**IMPORTANT INFORMATION**

See **Technical data, Page 223** for the dimensioning of the required AC line circuit breaker.

Single-wire cables (type NYY-J or NYM-J) without core end sleeves can be used with the AC terminal.

When using cables with fine wires (type H05../H07RN-F), core end sleeves must be used. Ensure that the contact length is 18 mm.

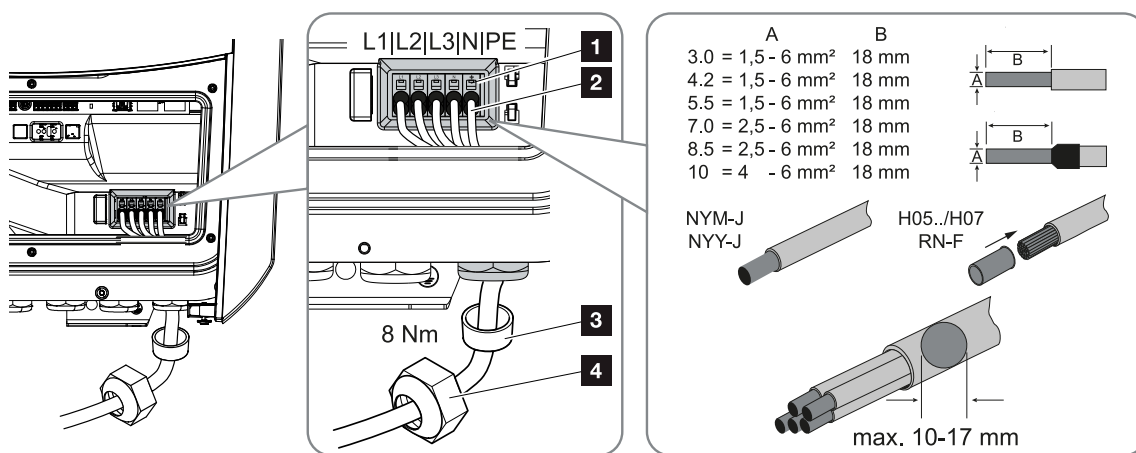

7. Insert mains cable (2) into the inverter and seal with sealing ring (3) and union nut (4). Tighten union nut to the prescribed torque. Torque: 8 Nm (M25).
8. When threaded connections are not used, leave the sealing ring in the threaded connections.
9. Connect the wires of the mains cable to the AC terminal (1) in accordance with the labelling.

**IMPORTANT INFORMATION**

To connect the AC cables, the inverter is equipped with spring-loaded terminal strips. For this, the wires should be inserted into the large round openings (lt. 1) of the terminal. The length of stripped insulation is 18 mm. Core end sleeves should be used with stranded cables.



1

2

3

4

5

6

7

8

9

10

11

12

13

14

15

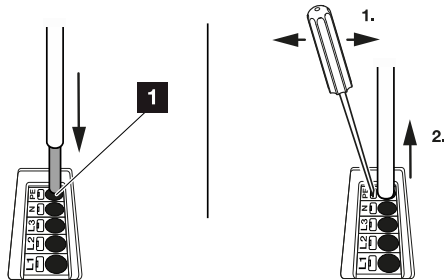

10. Install a line circuit breaker in the mains cable between the inverter and the feed meter to protect it against overcurrent.

**CAUTION****Risk of fire due to overcurrent and heating of the mains cable**

If mains cables are too small, they can heat up and cause a fire.

- Use a suitable cross-section
- Install line circuit breaker to secure against overcurrent.

**IMPORTANT INFORMATION**

This product may generate a direct current in the outer protective earthing conductor. A type A or B RCD ≥ 300 mA can be used on the AC side as a residual current device (RCD). Use of a type A RCD is enabled in the Webserver by going to **Service menu** > **External hardware settings** > **Residual current protection equipment**. (Default setting: type A RCD enabled.)

11. In countries in which a second PE connection is required, connect this at the marked place on the housing (outside).

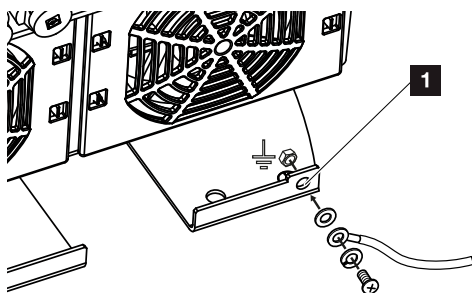

- ✓ The AC connection is connected.

3.6 Overview of Smart Communication Board (SCB)

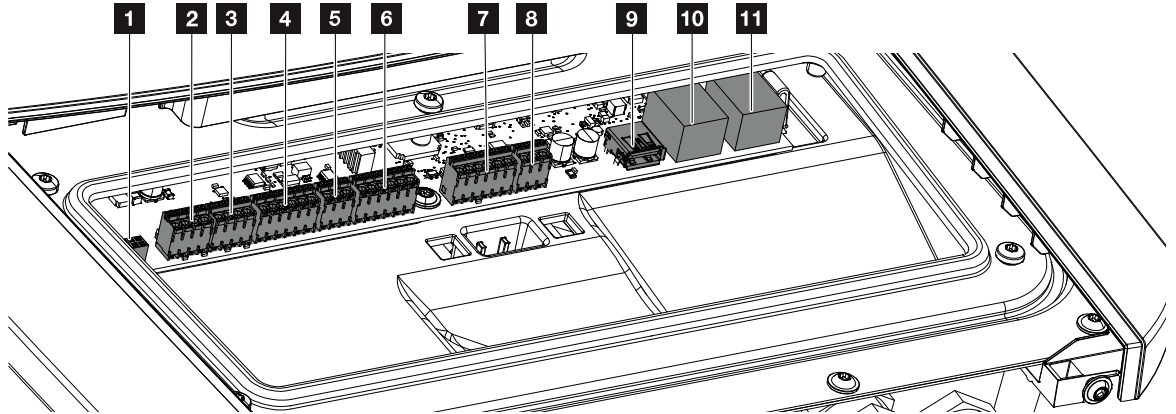

Item	Designation	Terminal	Pin	Explanation
1	Not used	X603		-
2	Digital switched outputs	X1401	1–2	Potential-free switched outputs OUT 1 (NO or NC contact)
			3–4	Potential-free switched outputs OUT 2 (NO or NC contact)
3	Digital switched outputs	X1402	5–6	Potential-free switched outputs OUT 3 (NO or NC contact)
			7–8	Potential-free switched outputs OUT 4 (NO or NC contact)
4	Digital interface terminal for ripple control receiver/external battery control	X401	1	REF (+12 to 14 V supply voltage)
			2	Input 1
			3	Input 2
			4	Input 3
			5	Input 4
			6	COM (0 V ground)
5	Terminal for ripple control receiver CEI for Italy	X403	1	common ref connection
			2	commando locale connection
			3	segnale esterno connection
6	Battery communication terminal	X601	1	VDD (+12 to 14 V supply voltage)
			2	CANopen High interface (data +)
			3	CANopen Low interface (data -)

Item	Designation	Terminal	Pin	Explanation
			4	RS485 interface B
			5	RS485 interface A
			6	GND (0 V ground)
7	SPD monitor input connection (evaluating external overvoltage protection device)	X402	1	Not used
			2	
			3	
			4	
			5	PLC monitor
			6	GND (0 V ground)
8	Terminal for energy meter (Modbus RTU)	X452	1	Interface A RS485/Modbus RTU
			2	Interface B RS485/Modbus RTU
			3	GND
9	USB 2.0 interface	X171	1	USB 2.0 max. 500 mA (for service purposes)
10	Ethernet connection (RJ45)	X207	1	RJ45 max. 100 Mbit (LAN connection for connection e.g. to a router or for other devices, e.g. inverter, KSEM)
11		X206	1	

3.7 Energy meter connection

Wiring diagram for energy meter – house connection (position 1)

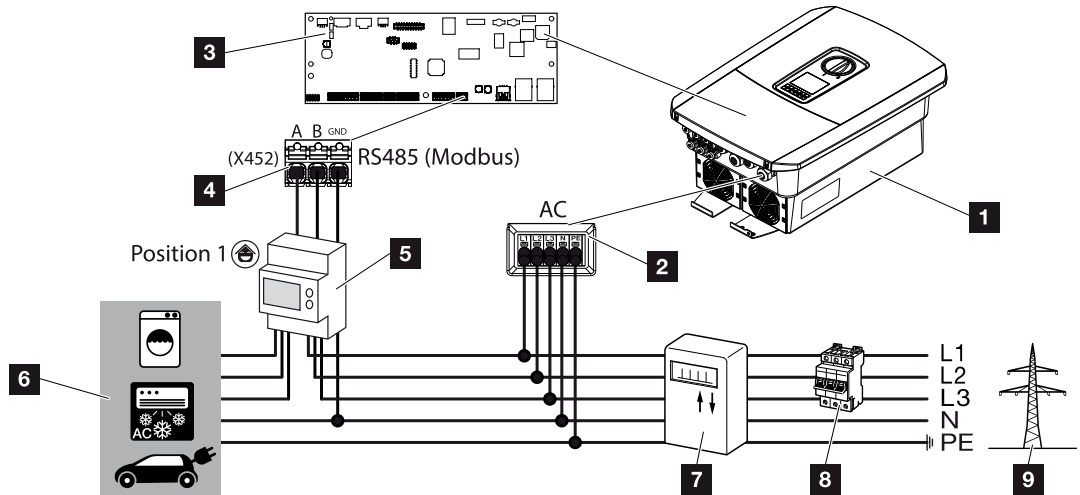

Wiring diagram for energy meter – grid connection (position 2)

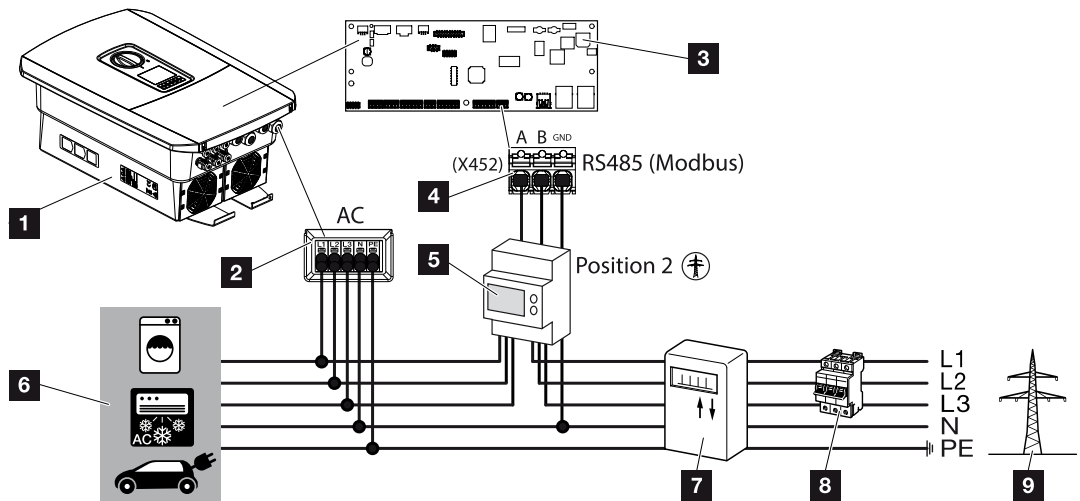

- 1 Inverter
- 2 Inverter – AC terminal
- 3 Smart Communication Board
- 4 Terminal for energy meter
- 5 Digital energy meter (Modbus RTU)
- 6 Consumer device



1

2

3

4

5

6

7

8

9

10

11

12

13

14

15

- 7 Purchase and feed meter or smart meter
- 8 Line fuse for house
- 9 Public grid



Connecting energy meter

The energy meter is installed on a top-hat rail in the meter box or the main distributor.



INFO

Only energy meters which have been approved for the inverter by KOSTAL Solar Electric may be used.

You will find an [up-to-date list of approved energy meters](#) in the download area for the product on our website.

The energy meter can be fitted in 2 positions in the house network (position 1 = home consumption, position 2 = grid connection point). Both installation positions are possible, but position 2 is preferable. The installation position is queried and set in the installation wizard or can be set in the Webserver.

The diagram only provides one example because the connections may differ depending on the energy meter used.

1. De-energise the house grid.



DANGER

Risk of death due to electrical shock and discharge!

De-energise device and secure against being switched on again. **De-energising the inverter, Page 99**

2. Fit the energy meter on the top-hat rail in the control cabinet or power distributor.
3. Correctly route the communication cable from the inverter to the control cabinet and connect to the energy meter following the wiring diagram provided by the manufacturer.



INFO

The communication cable is subject to the following requirements:

Conductor cross-section from 0.2 to 1.5 mm²

Max. length 30 m

Length of stripped insulation 8 mm

Observe the specifications for cable cross-sections in the instructions for the energy meter.

4. Connect communication cable in inverter to terminal for energy meter.



1

2

3

4

5

6

7

8

9

10

11

12

13

14

15

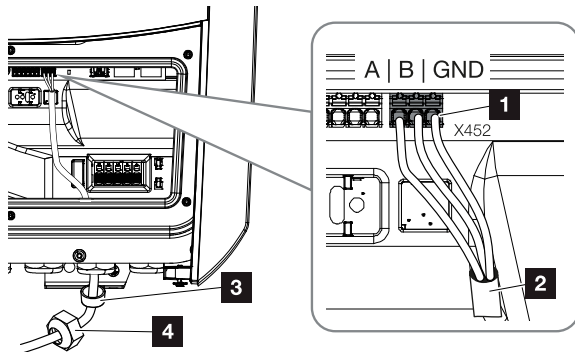

- 1 Terminal for energy meter (Modbus RTU)
 - 2 Communication cable to energy meter
 - 3 Sealing ring
 - 4 Union nut
- ✓ The energy meter is connected.

The type of energy meter used is selected when the inverter is first installed or can be set using the inverter menu or Webserver.

3.8 Connecting ripple control receiver

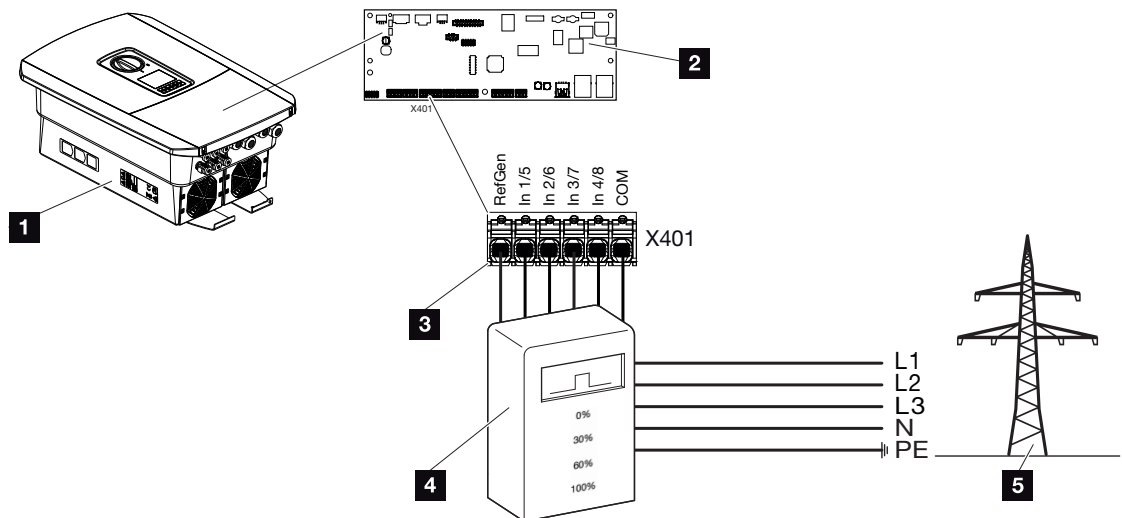

- 1 Inverter
- 2 Smart Communication Board (SCB)
- 3 Control line for ripple control receiver
- 4 Ripple control receiver
- 5 Energy supply company

Several energy supply companies offer the owners of PV systems the possibility of regulating their system with variable active power control and thus increasing the feed-in into the public grid to up to 100 %.

i INFO

In some applications, a compatible energy meter may be seen as an attractively priced alternative to the ripple control receiver. Here the feed-in may well be limited by the energy supply company, but the inverter controls the flow of energy (self-consumption in house grid and feed-in to the public grid) in such a way that the self-produced energy is not lost or loss is kept to an absolute minimum.

Dynamic active power control can be activated in the inverter to this end. **☑ Active power control, Page 189**

Ask your energy supply company or installer what application rule applies to you or whether there is an alternative (e.g. smart meter) better suited to you.

If a ripple control receiver is already connected to another KOSTAL inverter in your house network, you can use the control signals of this ripple control receiver. In order to do this, receipt of broadcast control signals must be activated in the Webserver by going to **Service menu > Energy management.☑ Webserver menu – Service menu – General, Page 155**



1

2

3

4

5

6

7

8

9

10

11

12

13

14

15

Connecting ripple control receiver

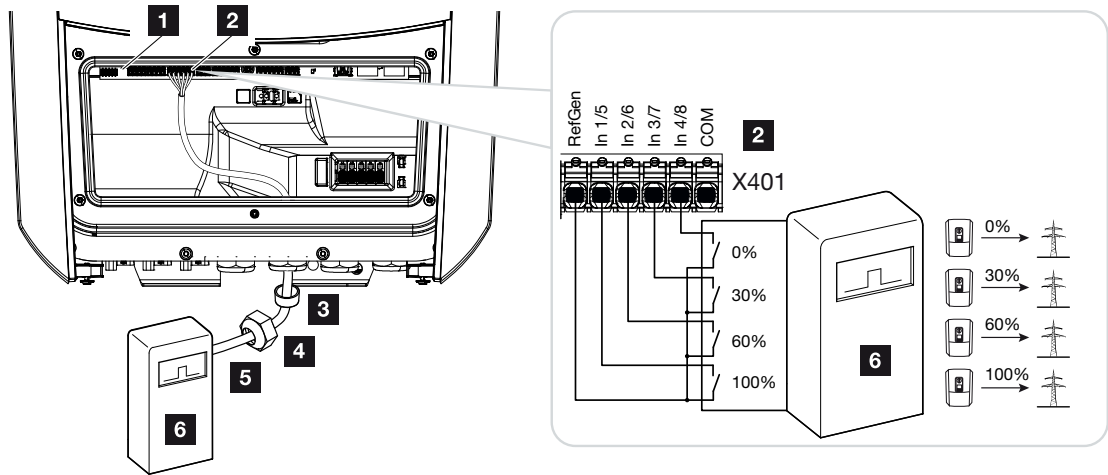

Fig. 1: Ripple control receiver electrical connection

- 1 Smart Communication Board
- 2 Terminal
- 3 Sealing ring
- 4 Union nut
- 5 Control line
- 6 Ripple control receiver



1

2

3

4

5

6

7

8

9

10

11

12

13

14

15

Connecting CEI control signals for Italy

For Italy, the ripple control receiver is connected as follows.

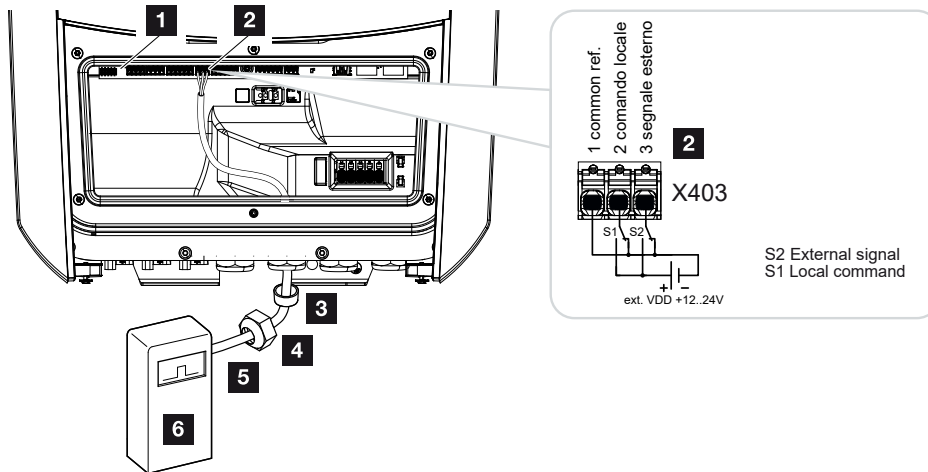

- 1 Smart Communication Board
- 2 Terminal
- 3 Sealing ring
- 4 Union nut
- 5 Control line
- 6 Ripple control receiver



IMPORTANT INFORMATION

For Italy (standard CEI0-21), there must be no voltage applied to terminal X403 (VDD). Connection to an external voltage source and a changeover switch to GND is mandatory here.



1

2

3

4

5

6

7

8

9

10

11

12

13

14

15

Trip control signal connection at inverter

If the inverter is to be controlled by the energy supplier via an external trip control signal, this is connected to the inverter as follows. No further settings are required in the inverter's Webserver for this function.

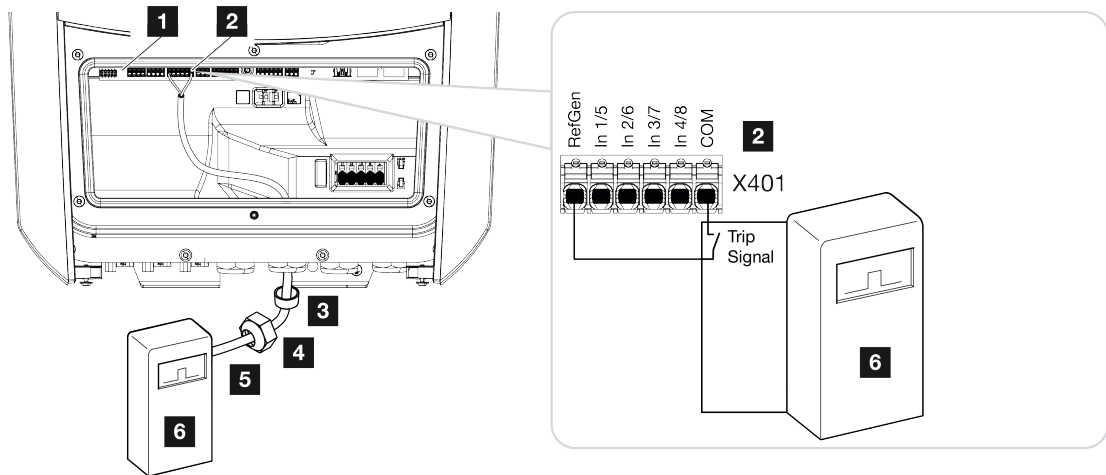

- 1 Smart Communication Board
- 2 Terminal
- 3 Sealing ring
- 4 Union nut
- 5 Control line
- 6 Ripple control receiver from the energy supply company with trip signal



Electrical connection

Perform the following steps:

1. De-energise the house grid.



DANGER

Risk of death due to electrical shock and discharge!

De-energise device and secure against being switched on again. [☑ De-energising the inverter, Page 99](#)

2. Fit ripple control receiver in control cabinet or power distributor.
 3. Correctly route the communication cable from the inverter to the control cabinet and connect to the ripple control receiver following the wiring diagram provided by the manufacturer.
 4. Connect communication cable in inverter to terminal for ripple control receiver (torque: 0.2 Nm).
 5. Once the inverter has undergone initial commissioning, the ripple control receiver must still be configured in the Webserver. The function that forwards the ripple control receiver's signals (distribution of broadcast control signals) to other inverters in the same house network can also be activated. [☑ Activating active power control, Page 193](#)
- ✓ The ripple control receiver is connected.

More information about configuration [☑ Active power control, Page 189](#)

3.9 Connecting the signal contact for the external overvoltage protection (SPD – Surge Protective Device)

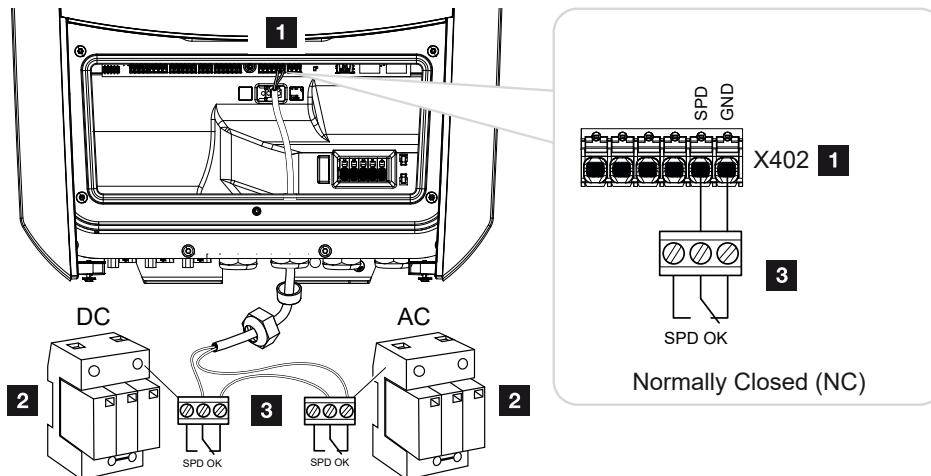

Fig. 2: Overvoltage protection (SPD) as NC contact

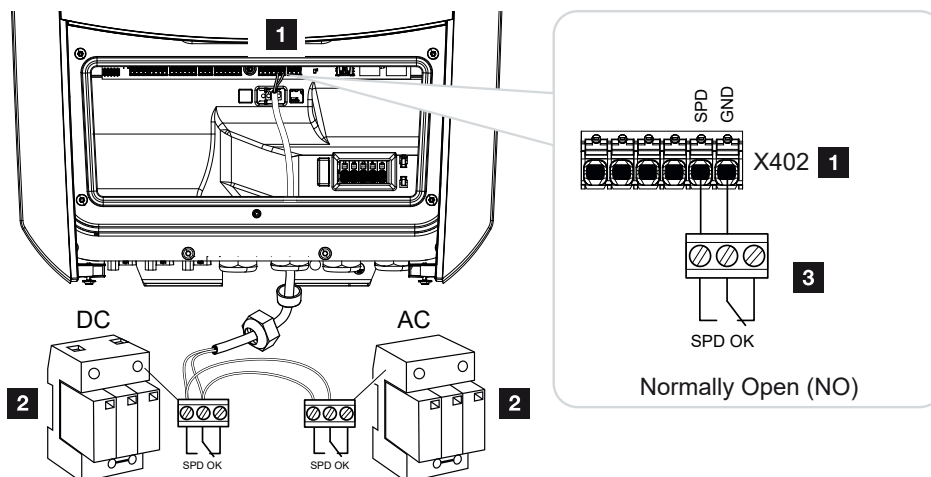

Fig. 3: Overvoltage protection as NO contact

- 1 Connection terminal X402 for Smart Communication Board (SCB)
- 2 Surge protection devices (SPD) for AC and DC side
- 3 Control line from SPD to inverter

To protect the PV system from overvoltages, overvoltage protection (SPD type 2) should be installed on the DC side between the inverter and the PV generator and on the AC side between the inverter and the grid.



1

2

3

4

5

6

7

8

9

10

11

12

13

14

15

The inverter can evaluate the message output of the overvoltage modules (SPD) and output a message if an event occurs. The cable is connected without potential to the inverter's terminal X402 by the SPD. After commissioning the inverter, the overvoltage protection must be configured in the Webserver as normally open (NO) or normally closed (NC).

Perform the following steps

1. De-energise the house grid.



DANGER

Risk of death due to electrical shock and discharge!

De-energise device and secure against being switched on again. **De-energising the inverter, Page 99**

2. Install the surge protection device (SPD) for AC and DC in the control cabinet or power distributor.
3. Correctly route the signal cable from the inverter to the control cabinet and connect to the SPD following the wiring diagram provided by the manufacturer.
With two SPDs, pay attention to how the signal cables are connected to each other: Series (for NC) or parallel (for NO).



INFO

The signal cable is subject to the following requirements:

Conductor cross-section from 0.2 to 1.5 mm²

Max. length 30 m

Length of stripped insulation 8 mm

Observe the specifications for cable cross-sections in the manufacturer's instructions.

4. Connect the communication cable in the inverter to terminal X402 for the surge protection device.
 5. Once the inverter has undergone initial commissioning, the overvoltage protection must still be configured in the Webserver. **Webserver menu – Service menu – General, Page 162**
- The overvoltage protection is connected.



1

2

3

4

5

6

7

8

9

10

11

12

13

14

15

3.10 Connection of switched outputs

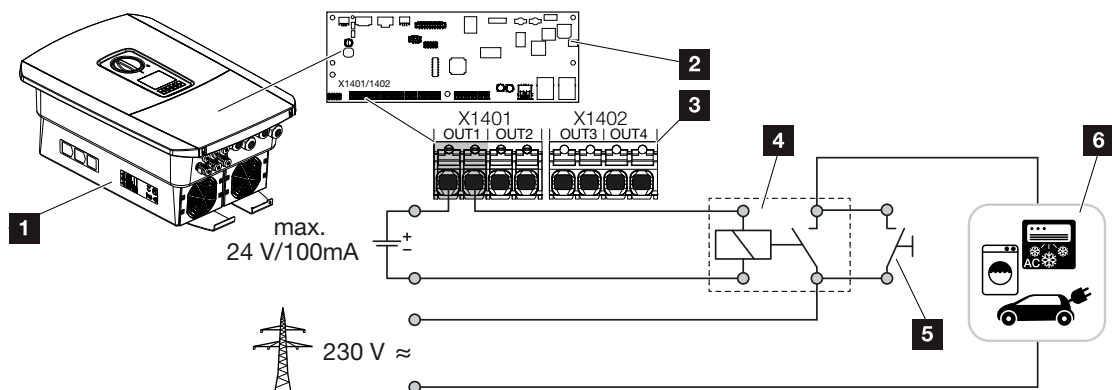

- 1 Inverter
- 2 Smart Communication Board
- 3 Terminal with four switched outputs (OUT 1-4)
- 4 Load relay
- 5 Jumper switch
- 6 Consumers/actuators

The inverter allows consumers to be connected to it via an external load relay, which can be switched on when there is sufficient PV or grid surplus feed-in power and thereby use the PV energy generated at that point in time.

If there is an event message, the inverter can trigger an actuator connected to the switched output (warning light, message signal, smart home system), providing information about the event that occurred.

i INFO

The communication cable is subject to the following requirements:

Wire cross-section from 0.2 to 1.5 mm²



Length of stripped insulation 8 mm

More information about connection and configuration **☑ Switched outputs, Page 169.**



3.11 Communication connection

The inverter offers two ways to connect to other devices, the local home network or the Internet. Two LAN interfaces and Wifi are available in the inverter for this purpose.

-  **Connection via LAN, Page 71**
-  **Connection via Wifi, Page 73**

Connection via LAN

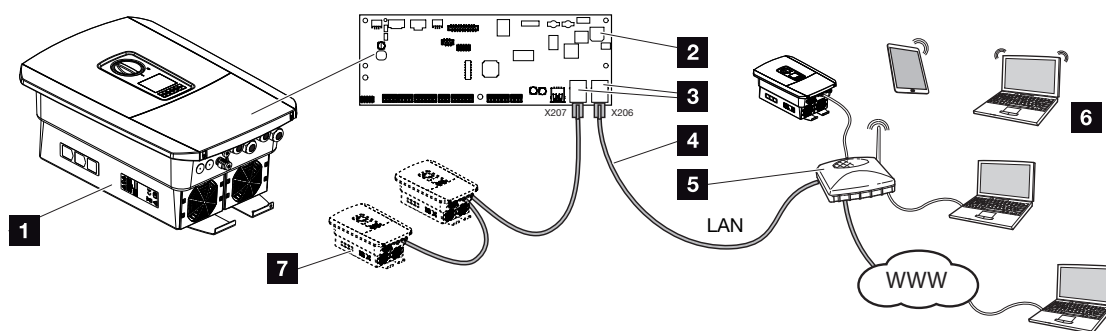

- 1 Inverter
- 2 Smart Communication Board
- 3 RJ45 connection sockets (Ethernet/LAN)
- 4 LAN cable
- 5 Router with access to the Internet
- 6 Computer/router/tablet/KOSTAL inverter (for configuration or data retrieval)
- 7 Other devices connected via LAN, e.g. KOSTAL solar inverter

The Smart Communication Board is the inverter's communication hub. Computers, routers, switches and/or hubs can be connected to the RJ45 connections.

If the Ethernet cable is connected to a router, the inverter is integrated into your own network and can be contacted by all computers or KOSTAL inverters incorporated into the same network.

Additional LAN devices can be connected via the second LAN interface in the inverter. Here, the inverter serves as a switch.



1

2

3

4

5

6

7

8

9

10

11

12

13

14

15

Connecting communication

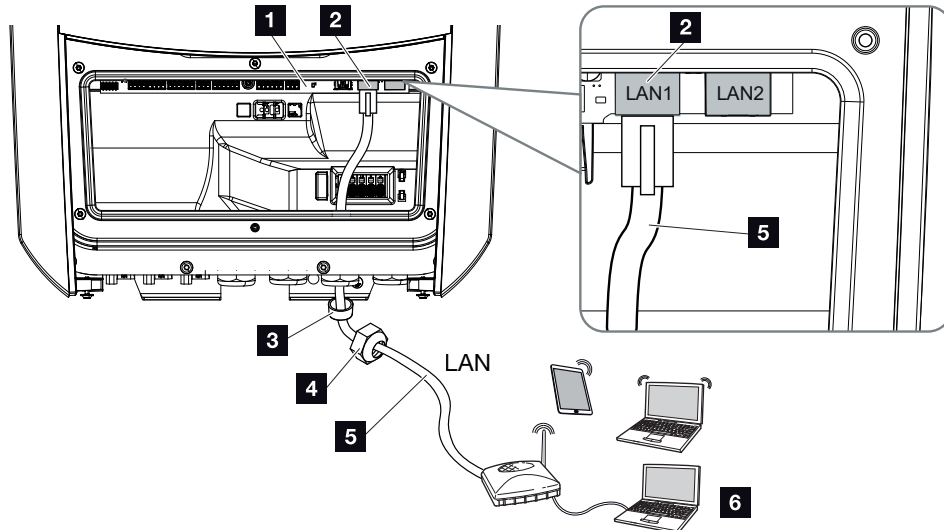

- 1 Smart Communication Board
- 2 LAN connection (RJ45 Ethernet)
- 3 Sealing ring
- 4 Union nut
- 5 Ethernet cable
- 6 Computer (for configuration or data retrieval)

1. De-energise the inverter's terminal compartment.



DANGER

Risk of death due to electrical shock and discharge!

De-energise device and secure against being switched on again. **De-energising the inverter, Page 99**

2. Insert Ethernet cable into the inverter and seal with sealing ring and union nut. Tighten union nut to the prescribed torque. Torque: 8 Nm (M25).



INFO

For connection with a computer or computer network (Ethernet 10BaseT, 10/100 Mbit/s), an Ethernet cable of category 5 (Cat 5e, FTP) or better with a max. length of 100 m is to be used.

3. Connect Ethernet cable to LAN interface of Smart Communication Board.



1

2

3

4

5

6

7

8

9

10

11

12

13

14

15

4. Connect the Ethernet cable to the computer or router.
- ✓ The inverter is connected to the internal network.

Connection via Wifi

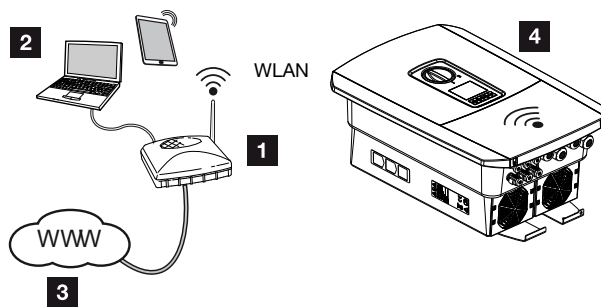

- 1 Router (Wifi/LAN) in the home network with access to the Internet
- 2 Computer/tablet (for configuration or data retrieval)
- 3 Internet
- 4 Inverter with Wifi client

If you want to connect the inverter to the home network via Wifi, it is important to have a sufficiently strong signal quality at the installation site **Wifi installation site, Page 51**

The connection to the router can be configured during the initial installation or later via the inverter's Webserver.

To do this, the Wifi interface in the inverter must be set to **Client mode** via the Webserver under **Settings > Network > Wifi > Wifi mode** and a wireless network must be selected.



1

2

3

4

5

6

7

8

9

10

11

12

13

14

15

3.12 Connecting battery

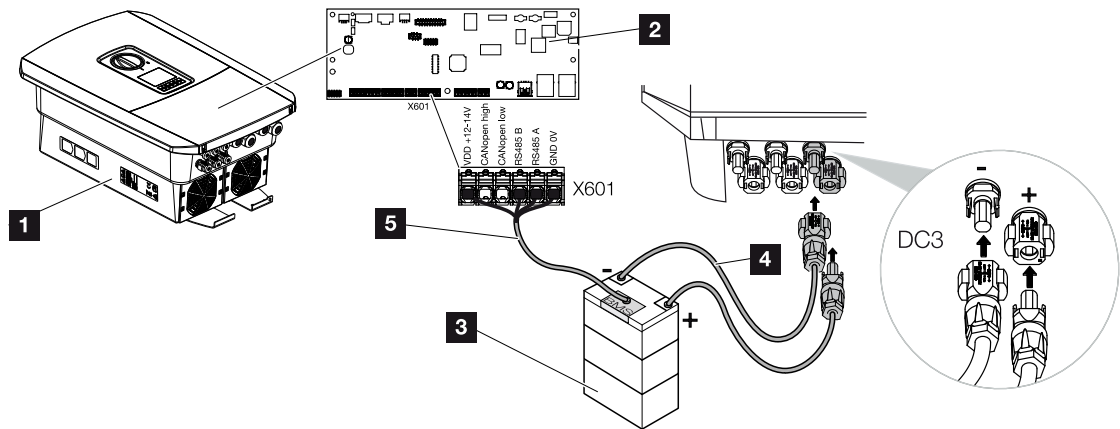

- 1 Inverter PLENTICORE plus G2
- 2 Smart Communication Board
- 3 Battery storage with battery management system
- 4 DC cables for battery storage
- 5 Communication cable to battery storage

On the inverter, you can connect a battery storage system to DC input 3 in place of a PV string.

However, this can only be done if DC input 3 has been released for this option. The battery storage connection is activated by entering a battery activation code. You can purchase the battery activation code from the KOSTAL Solar online shop.

Please note the following:

- Battery use must be released in the inverter.
- Only battery storage systems (manufacturers) which have been approved by KOSTAL Solar Electric GmbH may be connected to the inverter.



Activation of battery input

If DC input 3 on the inverter has not been activated for battery use, the battery activation code must be entered in the inverter so that it can be activated. There are three ways of doing this.

INFO

Be sure to use a valid activation code. If the details entered are incorrect, the inverter will be blocked after the 5th attempt and can only be enabled again by completely disconnecting the inverter from the AC and DC voltage supply.

Inputting code upon initial commissioning:

1. During initial commissioning, the commissioning wizard asks for the battery activation code under Extra options. When this happens, enter the 10-digit battery activation code using the control buttons on the inverter and confirm your input.
 2. Once this is acknowledged, DC input 3 can be used to connect battery storage and a battery type can be selected.
- ✓ Activation is complete.

Inputting code via Webserver:

After initial commissioning, the battery activation code can be entered via the Webserver.

1. Calling up Webserver
 2. Go to **Service menu** > **Extra options** > **Release new option**.
 3. Enter the 10-digit battery activation code and confirm. The battery type should then be selected.
- ✓ Activation is complete.

Inputting code via inverter menu:

1. After initial commissioning, the battery activation code can be entered in the inverter via the following menu item:
 2. **Settings** > **Extra options** > **Activate options**
 3. Enter the 10-digit battery activation code and confirm. The battery type should then be selected.
- ✓ Activation is complete.



Connecting battery communication

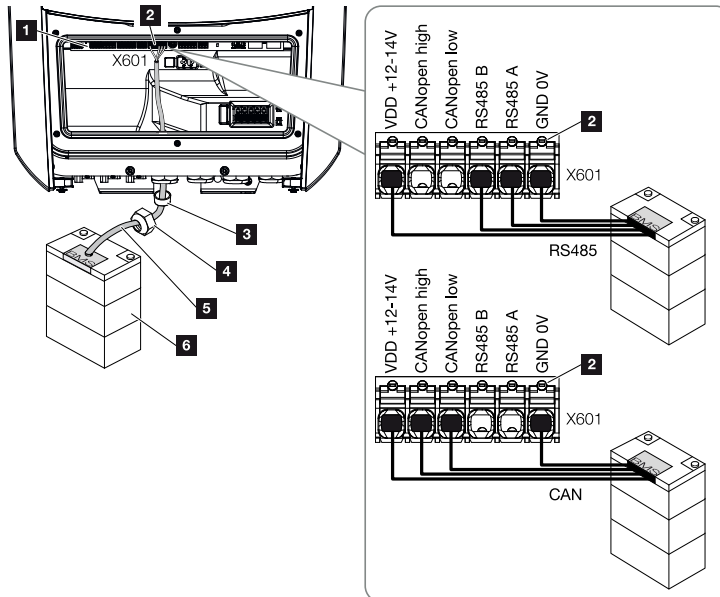

- 1 Smart Communication Board
- 2 Battery storage communication line terminal (depending on battery system)
- 3 Sealing ring
- 4 Union nut
- 5 Control line
- 6 Battery storage

1. The communication cable may only be connected to the inverter if the terminal compartment of the inverter and battery storage are voltage-free. De-energise inverter and battery storage.



DANGER

Risk of death due to electrical shock and discharge!

During operation, high voltages are present on the live parts and cables inside the product. Touching live parts or cables will result in death or life-threatening injuries from electrical shock.

- De-energise inverter and battery storage. Please also observe the instructions in the operating manual provided by the battery manufacturer.

2. Insert communication cable of battery storage into the inverter and seal with sealing ring and union nut. Tighten union nut to the prescribed torque. Torque: 8 Nm (M25).



1

2

3

4

5

6

7

8

9

10

11

12

13

14

15

i INFO

The communication cable is subject to at least the following requirements. Please consult the manual provided by the battery manufacturer for more details.

Wire cross-section 0.2-1.5 mm²

Outer diameter 5-10 mm

Max. length 30 m

Length of stripped insulation 8 mm

Twisted pair (e.g. Cat. 5e or better)

3. Connect the communication cable to the communication interface of the Smart Communication Board.
4. In the battery storage unit, connect the communication cable to the battery management system. To do this, consult the operating manual provided by the battery manufacturer.

i INFO

To prevent communication errors between the battery and the inverter, both devices must be connected via an earth potential.

- ✓ The communication cable has been connected.



1

2

3

4

5

6

7

8

9

10

11

12

13

14

15

3.13 Closing the inverter

1. Tighten all cable glands and check that they are properly sealed.
2. Check the fit of connected wires and strands in the inverter.
3. Remove any foreign objects (tools, wire cuttings, etc.) from the inverter.
4. Install the terminal compartment cover and screw it tight (2.0 Nm).
5. Fit cover on inverter and screw it tight (1.5Nm).

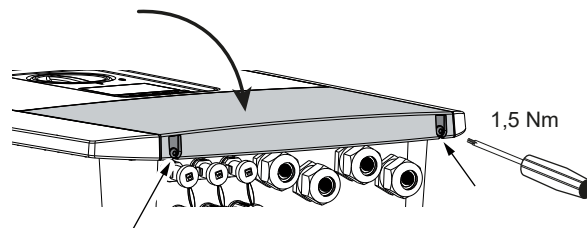
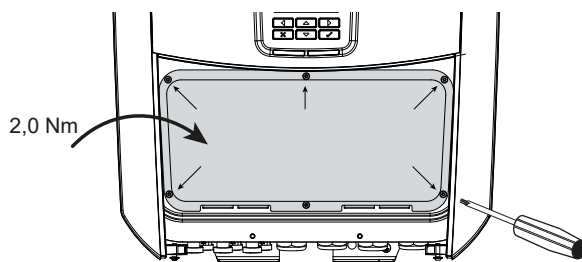



3.14 Connecting battery's DC cables

The battery's DC cables may only be connected to the inverter if the inverter and battery storage are voltage-free.

1. De-energise the battery storage and inverter.



DANGER

Risk of death due to electrical shock and discharge!

The battery's DC cables may be energised.

- Be sure to de-energise the battery storage system. Please also observe the instructions in the operating manual provided by the battery manufacturer.
-
2. Correctly fit the plug on the positive cable and the socket on the negative cable. The inverter is equipped with plug connectors from PHOENIX CONTACT (type SUNCLIX). During installation, always observe the most recent specifications from the manufacturer (e.g. permissible tightening torque etc.). Information on the SUNCLIX installation instructions can be found at: www.phoenixcontact.com
 3. When mounting the sockets and plugs on the battery's DC cables, ensure their polarity is correct!



IMPORTANT INFORMATION

Use flexible and tin-plated cables with double insulation according to EN 50618.

We recommend a cross-section of 6 mm². Please observe the specifications of the plug manufacturer and the technical data for the inverter.

4. Plug the sockets and plugs of the battery's DC cables onto the inverter. Retain the plug seals from the plug connectors.



1

2

3

4

5

6

7

8

9

10

11

12

13

14

15

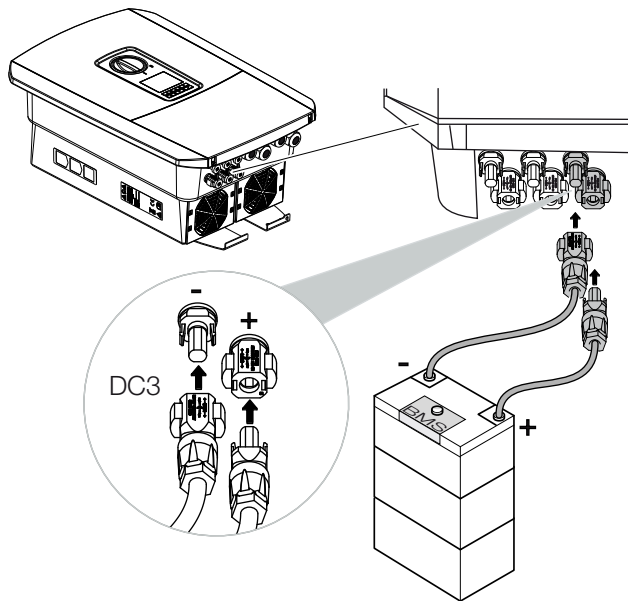

5. Configuration and selection of battery type must take place after initial installation in the Webserver.
- ✓ The battery's DC cables are connected.



3.15 Connecting solar module

Solar module connections



WARNING

Risk of fire due to improper installation!

Incorrectly fitted plugs and sockets may heat up and cause a fire. During installation, be sure to follow the manufacturer's requirements and manual. Properly mount plugs and sockets.



WARNING

Serious burns due to arcs on the DC side!

DC cables must never be connected to or disconnected from the device during operation, as dangerous arcs may form. De-energise DC side, then mount or remove plug connector!



WARNING

Injuries can result from destruction of the device!

When the maximum permitted input voltage/current at the DC inputs is exceeded, this may result in serious damage, which may destroy the device and cause serious injury to anyone present. Even briefly exceeding the voltage can cause damage to the device.

Note the following before connecting the DC plugs

- In order to ensure an optimal layout of the solar modules and the highest possible yields, the system should be designed within the voltage range between U_{MPPmin} and U_{MPPmax} . KOSTAL Solar Plan should be used as a planning tool for this.
- Check for the correct planning and wiring of the modules and then measure the DC idling voltage.
- Please ensure that the maximum permitted DC idling voltage is not exceeded.
- Log these measuring values and make them available in the event of complaints.
- If the output of the solar modules is higher than that specified in the technical data, it must be ensured that the working point is still within the MPP voltage range of the inverter.
- The solar module types used in one PV string should all be the same. This avoids loss of yield.



1

2

3

4

5

6

7

8

9

10

11

12

13

14

15

- The maximum short-circuit current of the PV string must not exceed the maximum permissible short-circuit current of the inverter's DC connections.

Failure to comply with this will render any manufacturer's warranty, guarantee or liability null and void unless it can be proven that the damage was not due to non-compliance.



Connecting solar modules

Only solar modules of the following category may be connected: Class A as specified in IEC 61730.

The PV generators may only be connected to the inverter when this is voltage-free.



DANGER

Risk of death due to electrical shock and discharge!

The PV generators/cables may be live as soon as they are exposed to light.

1. De-energise the inverter.



DANGER

Risk of death due to electrical shock and discharge!

De-energise device and secure against being switched on again.  **De-energising the inverter, Page 99**

2. If there is more than one inverter in a PV system, ensure that no cross-connection occurs when the PV generators are connected.



INFO

Damage possible

If the PV generators are incorrectly connected (including cross-connection on the inverter itself), the inverter may be damaged. Check the connections before commissioning.

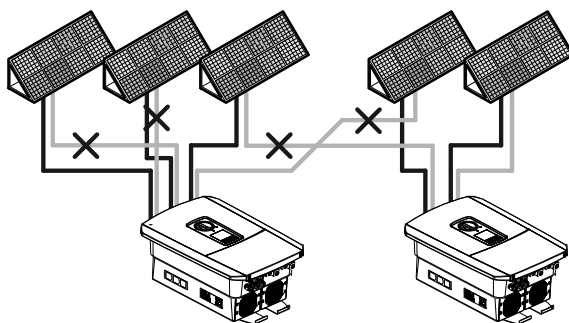

3. Check the strings for earth faults and short circuits and rectify these where appropriate.
4. Correctly fit the plug on the positive cable and the socket on the negative cable. The inverter is equipped with plug connectors from PHOENIX CONTACT (type SUNCLIX). During installation, always observe the most recent specifications from the manufac-



1

2

3

4

5

6

7

8

9

10

11

12

13

14

15

turer (e.g. use of special tools, permissible tightening torques etc.).
Information on the SUNCLIX installation instructions can be found at:
www.phoenixcontact.com

- When mounting the sockets and plugs on the DC cables used by the solar modules, ensure their polarity is correct! The poles of the PV strings (PV field) must not be earthed.



IMPORTANT INFORMATION

Use flexible and tin-plated cables with double insulation according to EN 50618.

We recommend a cross-section of 6mm². Please observe the specifications of the plug manufacturer and the technical data for the inverter.

- Plug the sockets and plugs of the DC cables onto the inverter. Retain the plug seals from the plug connectors.



IMPORTANT INFORMATION

The solar module types used and the orientation in one PV string should be the same.

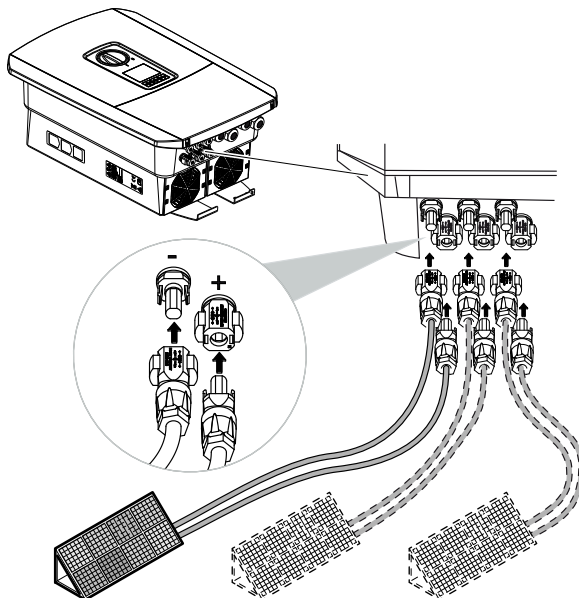

- ✓ The DC side is connected.



3.16 Initial commissioning

The display or the inverter's Webserver can be used for initial commissioning. The required activation codes are requested during initial commissioning.

Initial commissioning via display

The inverter display is used to carry out initial commissioning. Here, the data is entered on the inverter.

Initial commissioning via Webserver

The inverter's integrated Webserver is used to carry out initial commissioning. An additional device, e.g. a PC or smartphone that accesses the Webserver, is required to enter the data.

To do this, the user must first select and set up the network connection via the inverter display before a connection is made via the input device.

Possible connection types are:

- **Wifi access point:** After switching on the inverter, it provides a Wifi access point. A connection to the inverter's Wifi access point can be established using a smartphone. The access data for this is shown as a QR code on the inverter's display.
- **LAN:** The inverter is connected to the local network via a LAN connection. The Webserver can then be accessed via a LAN-enabled device.

After selecting the connection method, the inverter's website is accessed and initial commissioning can be carried out.



Initial commissioning procedure

1. Activate supply voltage via the line circuit breaker.
 2. Switch the inverter's DC switch to ON.
- The installation wizard is shown on the display.



INFO

The installation process may vary depending upon the software version of the inverter. Information on how to operate the menu: [☑ Control panel, Page 101](#)

Continue with:

- [☑ Initial commissioning via display, Page 87](#)
- [☑ Initial commissioning via web browser, Page 91](#)



Initial commissioning via display

The inverter display is used to carry out initial commissioning. Here, the data is entered on the inverter.

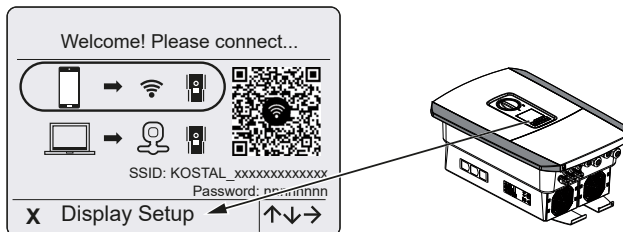

1. Press **X** on the inverter to start the installation via the display.
 - The **Language** menu is displayed.
2. Select language and confirm.
 - To do so, use the arrow keys to select a language. Confirm using **ENTER**.
3. Press the right arrow key to go to the next installation item.
 - The **Date and time** menu is displayed.
4. Select the time zone and set the date/time or have it detected automatically. Confirm using **ENTER**.

i INFO

Entering the date/time ensures that the downloaded log data has the correct time assigned to it.

5. Press the right arrow key to go to the next installation item.
 - The **Energy management** menu is displayed.
6. Use the arrow keys to select the corresponding menu item and press the **ENTER** key.
7. For **Max. grid feed-in**, enter the value that the energy supply company specified. Do this by pressing **ENTER** and using the arrow keys to enter the value. Confirm each digit with **ENTER**. At the end, confirm the input with $\sqrt{}$.
8. Use the arrow keys to select the **Energy meter** field and press **ENTER**. Select the installed energy meter from the list and confirm with **ENTER**.

i INFO

A list of **approved energy meters** and their purpose is available in the download area for the product on our website at www.kostal-solar-electric.com



1

2

3

4

5

6

7

8

9

10

11

12

13

14

15

9. Use the arrow keys to select the **Sensor position** field and press **ENTER**. Select the position of the installed energy meter in the building services and confirm with **ENTER**.

**INFO**

Position 1 (home consumption) or 2 (grid connection) states the installation position for the energy meter in the house grid.

10. Press the right arrow key to go to the next installation item.
 - The **Modbus SunSpec (TCP)** menu is displayed.
11. If you need the Modbus SunSpec protocol via TCP, e.g. for externally connected monitoring of the inverter, you can activate it here. Press **ENTER** to adopt the settings and activate the Modbus/SunSpec protocol.
12. Press the right arrow key to go to the next installation item.
 - The **Solar Portal** menu appears on the display.
13. Select the corresponding menu item with the arrow keys.
14. Press **ENTER** and select the solar portal you are using. Confirm the entries with **ENTER**.
15. To activate the transfer, highlight the item and confirm with the **ENTER** key.
 - The transfer is activated.
16. Press the right arrow key to go to the next installation item.
 - The **Extra options** menu appears on the display.

**INFO**

This item can be used to release options by entering an activation code in the inverter. The activation code, e.g. for connecting a battery to DC input 3 on the inverter, can be purchased from our online shop.

**INFO**

The extra options currently released are shown under **Released options**.

17. Select **Release option** and confirm the input with the **ENTER** key.
18. Enter the code you previously purchased from the KOSTAL Solar Webshop.
19. At the end, confirm the input with **√**.
20. Press the right arrow key to go to the next installation item.
 - The **Battery type** menu is displayed.



1

2

3

4

5

6

7

8

9

10

11

12

13

14

15

21. If you have enabled a battery system to be used, select the battery type with the arrow keys. Confirm the entries with **ENTER**.

INFO

A list of **approved battery storage systems** is available in the download area for the product on our website at www.kostal-solar-electric.com

22. Press the right arrow key to go to the next installation item.
→ The **Updates** menu appears on the display.
23. Select the update method for installing future software updates on the inverter. Confirm the entries with **ENTER**.

INFO

You can choose between the system update methods **Manual updates, Find out about updates** and **Automatic updates**. The **Automatic updates** method is recommended. For the system update methods **Find out about updates** and **Automatic updates**, the inverter must be connected to the Internet.

24. Press the right arrow key to go to the next installation item.
→ The **Country/guideline** menu appears on the display.
25. Select country or guideline used. Confirm the entries with **ENTER**.
26. Press the right arrow key to go to the next installation item.
→ **Apply settings** appears on the display.
27. Press **ENTER** to adopt the entries.

INFO

If an incorrect country setting has been selected, it can be reassigned using the inverter's menu item **Reset national guideline**.

28. The settings are applied by the inverter.
✓ The inverter restarts after the installation, if necessary. Initial commissioning is completed.

The inverter is in operation and can now be used.



1

2

3

4

5

6

7

8

9

10

11

12

13

14

15

i INFO

If there is a software update available for the inverter, install this first.

You can find the latest software update in the download area for the product on our website at www.kostal-solar-electric.com

i INFO

In France, the installer is personally responsible for obtaining any additional mandatory labels as required and attaching them to the inverter and feed cables.



1

2

3

4

5

6

7

8

9

10

11

12

13

14

15

Initial commissioning via web browser

Initial commissioning via the web browser can be carried out using the inverter's Wifi access point or a LAN connection.

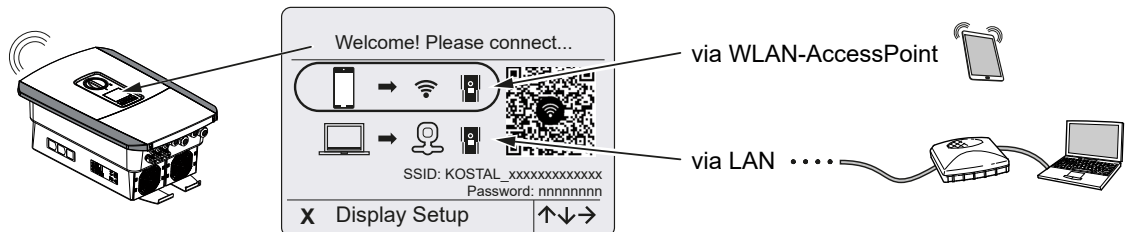

Select a connection for initial commissioning:

Selection: Wifi access point

The inverter's Wifi access point is used for the setup.

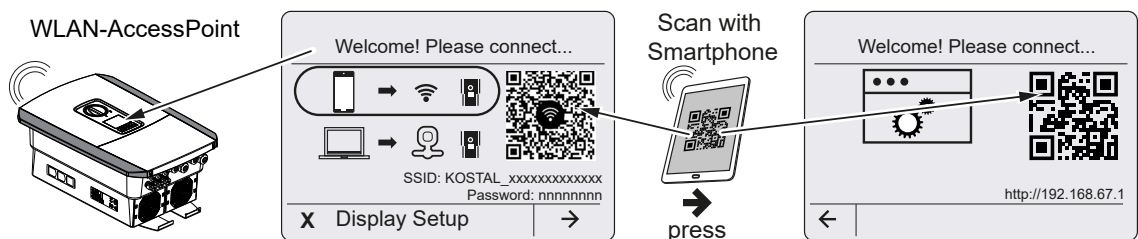

1. Choose to connect via the Wifi access point for initial commissioning:
2. Scan the QR code with your smartphone and connect to the inverter's Wifi access point. If this is not possible, you can establish the connection manually. Use the displayed SSID (KOSTAL_<inverter serial number>) and password (P<inverter item number>).
3. Press the right arrow key on the inverter.
 - The QR code for the Webserver for the initial setup wizard is displayed.
4. Scan the QR code for the Webserver with your smartphone or enter the IP address displayed.
 - ✓ The Webserver connection is established and the initial setup wizard is displayed. Continue with **Setup wizard, Page 93.**

If the Webserver initial setup wizard does not start in the browser, enter the Wifi IP address (192.168.67.1) shown on the inverter display into a web browser on your smartphone.

i INFO

If the settings for the Wifi access point are not changed after initial commissioning (SSID/ password), the Wifi access point will be deactivated again after 120 minutes for security reasons. The Wifi access point can be configured in the Webserver under **Settings > Network > Wifi > Wifi Mode > Access Point.**



1

2

3

4

5

6

7

8

9

10

11

12

13

14

15

Selection: LAN cable

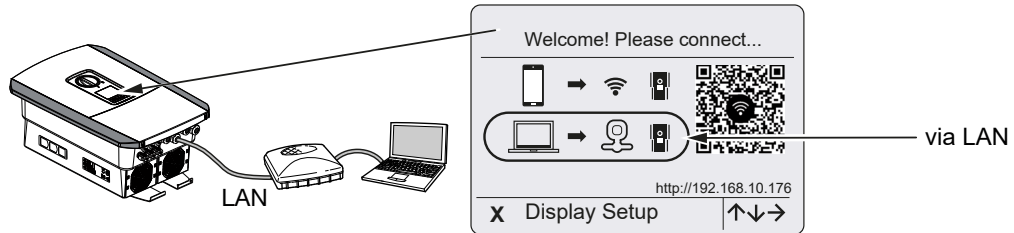

The inverter is connected to a router in the local network via a LAN cable and automatically obtains an IP address via a DHCP server.

1. The inverter's Webserver can now be accessed in a web browser using an input device (e.g. PC). To do this, enter the IP address shown on the inverter display into a web browser on your input device.
- ✓ The Webserver connection is established and the initial setup wizard is displayed. Continue with  **Setup wizard, Page 93.**



1

2

3

4

5

6

7

8

9

10

11

12

13

14

15

Setup wizard

As soon as the connection has been established, the web page for initial setup of the inverter opens automatically in the connected device's web browser. If this is not the case, please enter the inverter's IP address manually in the browser. The address is shown on the inverter display.



INFO

If a message appears saying that the inverter's Wifi is not connected to the Internet and mobile data should be used instead, continue to stay connected to the inverter's Wifi.

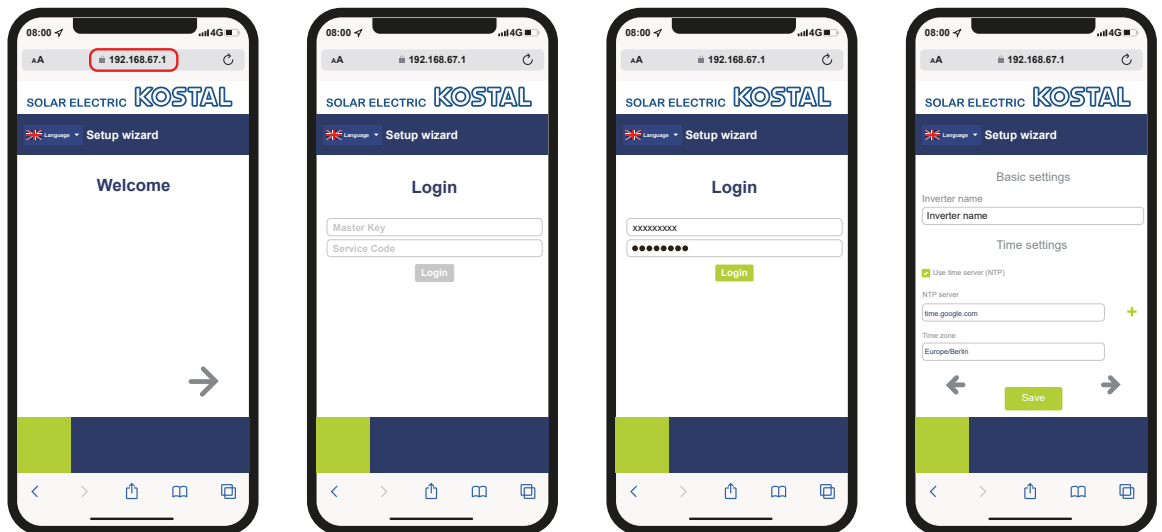

1. Press the right arrow key.
 2. Log in to the inverter as an **installer** with the **master key** and **service code** . You will find the **master key** on the inverter's type plate.
 3. Follow the instructions of the initial installation wizard. Information on the individual menu items can be found at  **Webserver– menus, Page 144**.
 4. Save each page using the **Save** button.
 5. Press the right arrow key to move to the next page.
- Setup completed.



1

2

3

4

5

6

7

8

9

10

11

12

13

14

15

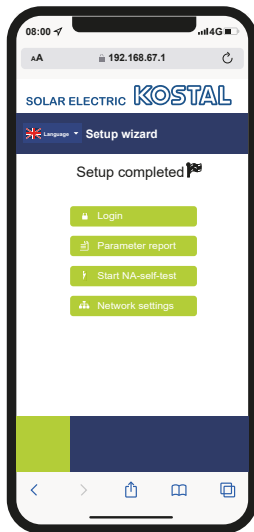

6. Finally, you can implement network settings, download the parameterisation report and, if necessary, start the NA protection self-test.
 - ✓ The inverter has been set up and is ready for operation.



3.17 Configuring settings in the Webserver

After the initial installation, more settings can be made using the inverter's menu or more conveniently via the Webserver.

To do this, use a PC or tablet to log in on the Webserver as an installer. Initial commissioning is completed.



INFO

Parameters governed by the grid, limitations and guidelines can only be modified with a service code.

To log in as an installer, you need the master key from the inverter's type plate and your service code, which can be requested from our service team.

Information about our service team can be found on our website at www.kostal-solar-electric.com > **Service and support**.

The following settings still need to be configured after initial commissioning:

- Inverter settings made by the installer
- Mandatory settings for grid feed-in defined by energy supply company.
- Registration for KOSTAL Solar Portal, if not already done.
- With a battery connected, select the battery type and configure the battery.
- Make further settings, such as changing the password or updating the inverter software.



4. Operation and operating the device

- 4.1 Switching on the inverter 97
- 4.2 Switching off the inverter 98
- 4.3 De-energising the inverter 99
- 4.4 When working on the DC feed cables 100
- 4.5 Control panel 101
- 4.6 Operational status (display) 103
- 4.7 Operational status (LEDs) 107
- 4.8 Inverter menu structure 108
- 4.9 Description of inverter menus 116



1

2

3

4

5

6

7

8

9

10

11

12

13

14

15

4.1 Switching on the inverter

1. Activate supply voltage via the line circuit breaker.
2. If present, switch on the battery storage unit using the battery switch.

INFO

For more information about operation, refer to the operating manual for the battery storage system.

- The battery storage unit starts up.
- 3. Move the DC switch on the inverter to ON position.  **DC switch on the inverter, Page 26**
If external DC voltage separators are present, activate the DC strings consecutively.
- The inverter starts up.
- During start-up, the LEDs in the control panel of the inverter light up briefly.
- The screensaver appears on the display and shows the device type. The screensaver is deactivated when a key is pressed twice.

INFO

When no key has been pressed for several minutes, the screensaver with the image of the inverter appears automatically on the display.

- ✓ The inverter is in operation.



1

2

3

4

5

6

7

8

9

10

11

12

13

14

15

4.2 Switching off the inverter

To interrupt the inverter's feed-in to the public grid, proceed as follows.

Additional steps are necessary for repair work on the inverter. **De-energising the inverter, Page 99.**

1. Turn the DC switch on the inverter to OFF. **DC switch on the inverter, Page 26**
2. If external DC voltage separators are present, switch off the DC strings consecutively.
3. If a battery is connected, switch off the battery storage.



INFO

A detailed description of how to switch off the battery storage is available in the operating manual provided by the battery manufacturer.

- ✓ The inverter no longer feeds into the public grid. The inverter remains energised and monitoring is still performed.



1

2

3

4

5

6

7

8

9

10

11

12

13

14

15

4.3 De-energising the inverter

When working in the terminal compartment

When working in the inverter's terminal compartment, this area must be de-energised.



DANGER

Risk of death due to electrical shock and discharge!

De-energise device and secure against being switched on again. **De-energising the inverter, Page 99**

It is imperative that these steps are carried out:

1. Turn the DC switch on the inverter to OFF. **DC switch on the inverter, Page 26**
 2. If used, switch off power supply for switched outputs **Switched outputs, Page 169**
 3. Switch off the AC line circuit breaker.
 4. Secure the entire voltage supply against being restarted.
- ✓ The inverter's terminal compartment is now voltage-free (high voltage). The Smart Communication Board (SCB) is still supplied with voltage by the PV string and can display values in the inverter's display. The levels of voltage on the SCB are very low and not dangerous at all. Work can now be carried out in the inverter's terminal compartment or on the AC line.



DANGER

Risk of death due to electrical shock and discharge!

Further steps should be taken when working on the DC feed cables (PV or battery). These steps can be found on the following page.



1

2

3

4

5

6

7

8

9

10

11

12

13

14

15

4.4 When working on the DC feed cables



DANGER

Risk of death due to electrical shock and discharge

During operation, high voltages are present on the live parts and cables inside the product. Touching live parts or cables will result in death or life-threatening injuries from electrical shock.

- Before opening the device, de-energise it and secure it against being switched on again.

When working on the DC feed cables, the inverter must be completely de-energised.

It is absolutely essential that these steps are taken in addition to those stated previously:

1. If present, switch off the connected battery storage.



INFO

A detailed description of how to switch off the battery storage is available in the operating manual provided by the battery manufacturer.

2. Disconnect all DC connections on the inverter. To do this, unlock the engaging clips with a screwdriver and disconnect the plug.



INFO

Information on the SUNCLIX mounting instructions can be found at:

www.phoenixcontact.com.

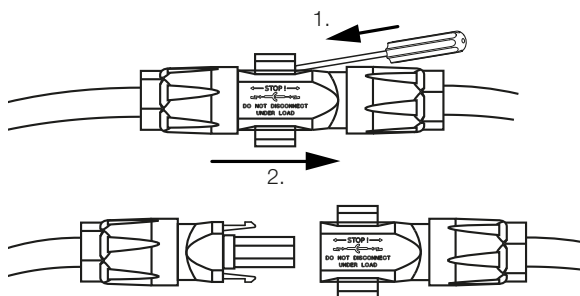

3. Ensure that all connections are voltage-free.
 - ✓ The inverter is now completely voltage-free. Work on the inverter or on the DC feed cables can now be carried out.

4.5 Control panel

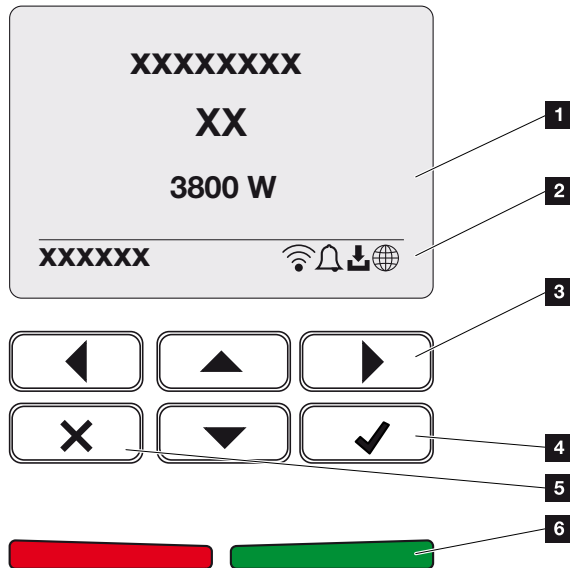

- 1 Display
- 2 Status display
- 3 Arrow key for navigating in the menus
- 4 ENTER key (for confirmation)
- 5 DELETE key (for clearing or for exiting the menu)
- 6 Status LEDs: fault (red), warning (flashing red), feed-in (green), feed-in limited (green flashing)

The inverter indicates the relevant operational status using two LEDs and the display.

i INFO

When no key has been pressed for several minutes, the screensaver with the image of the inverter appears automatically on the display.

The operating values can be retrieved and settings adjusted on the display.



1

2

3

4

5

6

7

8

9

10

11

12

13

14

15

Operation of the display

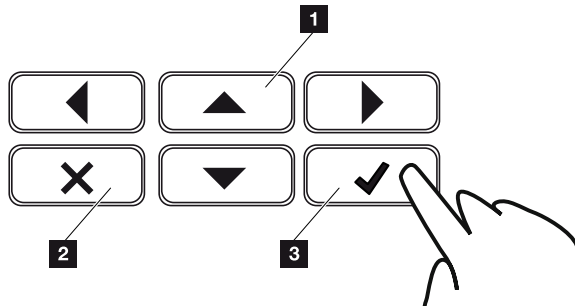

- 1 **UP/DOWN/LEFT/RIGHT:** Characters, buttons, functions and input fields are selected with the arrow keys.
- 2 **DELETE/Cancel:** Pressing **DELETE** deletes the selection, the entry or a value, cancels an entry or jumps to the menu above after confirming the entry.
- 3 **ENTER /Confirm:** Pressing the **ENTER** key activates the selected menu element or confirms the input. Touching the **ENTER** input box saves the value.

Entry of text and numbers

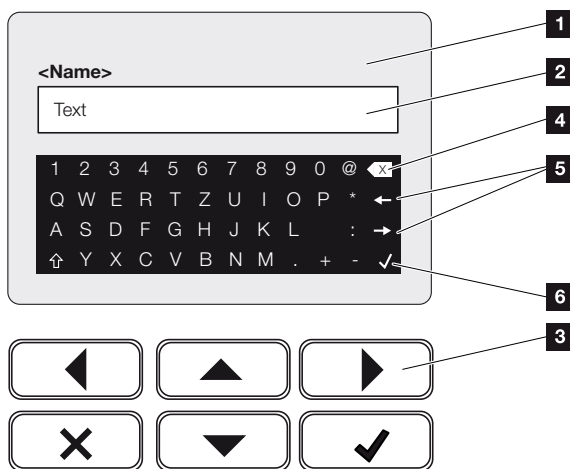

- 1 Inverter display
- 2 Input box
- 3 Select character using the arrow keys, confirm with **ENTER** or exit the menu with **X**.
- 4 Individual characters to the left of the cursor can be deleted with the backspace key.
- 5 The arrow keys can be used to move the cursor within the text.
- 6 Press the **ENTER** key to save the entry and close the menu.

The display can be used to enter texts and numbers (e.g. inverter name). When input is required, a keypad of letters and numbers appears under the input box in order to do this.

4.6 Operational status (display)

The inverter's operational statuses are shown on the inverter's display:

i INFO

the user interface/menu items in the inverter depend on the software installed in the inverter and may differ from the description here.

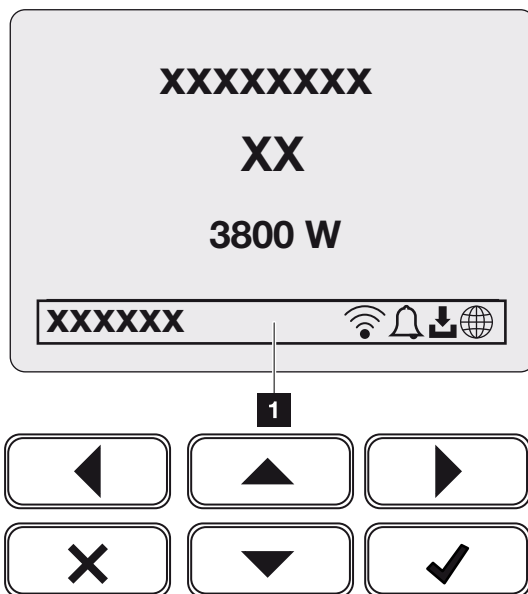



Fig. 4: Fig_control-panel_operational-status-G2

- 1 Display area, information and inverter status displayed

The following table explains the operational notifications that can appear on the display:

Symbol	Display	Explanation
---	Off	Input voltage on the DC side (photovoltaic modules) is too low or inverter switched off.
	Bell symbol	An event is present. Remedial measures can be found in the Event codes chapter Event codes, Page 222 . The event can be queried in the inverter menu by going to Service > Event list or can be viewed using the Down arrow key.



1

2

3

4

5

6

7

8

9

10



11

12

13

14

15

Symbol	Display	Explanation
	Software update symbol	There is a software update available for the inverter. The software update process can be started in the inverter menu under Service > Updates or via the inverter.
	Globe symbol	Shows a successful connection to the solar portal.
	Wifi icon	Displays the Wifi connection status.

Display	Explanation
IP address	The IP address of the inverter is displayed.
Insulation measurement	Device performs an internal check
Grid check	Device performs an internal check
Starting	Internal control measurements according to VDE 0126
Starting, including check of DC generators	Device performs an internal check
Feed in	Measurement successful, MPP control active (MPP = maximum power point)
Feed-in ext. regulated	Feed-in is regulated on the basis of a fault (e.g. PV energy is limited <input checked="" type="checkbox"/> Active power control, Page 189 , excess temperature, fault)
Shutdown by ext. signal	The feed-in is shut down as a result of an external signal from the energy supply company.
Event xxxx, yyyy	An event is present. Up to two active events can be displayed. Remedial measures can be found in the <input checked="" type="checkbox"/> Event codes, Page 222 "Event codes" chapter



1

2

3

4

5

6

7

8

9

10

11

12

13

14

15

Display	Explanation
Waiting time ...	<p>The device is not feeding into the public grid due to an event.</p> <p>Grid synchronisation: The inverter synchronizes itself with the public grid and feeds in.</p> <p>Grid check: A grid check is carried out.</p> <p>Grid error: There is an error in the public grid. As soon as this is rectified, the inverter feeds in again.</p> <p>Overheating: The inverter's temperature is too high. As soon as this has fallen, the inverter feeds in again.</p>
DC voltage too low	Electronics are ready for operation, DC voltage is still too low for feed-in.
Impermissible DC voltage	DC voltage still too high.
Ext. battery control active (only with battery connected)	The battery is controlled by an external management system. Ch. 8.1
Deep discharge protection (only with battery connected)	The battery which is connected to the inverter is charged from the public grid using an equalisation charge.
Equalisation charge (only with battery connected)	The battery which is connected to the inverter is charged from the public grid using an equalisation charge. It can only be activated with installer access via the service menu.
Service charging (only with battery connected)	The battery which is connected to the inverter is charged from the public grid using an equalisation charge. It must be activated via the service menu. It can only be activated with installer access via the service menu.



1

2

3

4

5

6

7

8

9

10

11

12

13

14

15

Display	Explanation
<p>Battery sleep mode (only with battery connected)</p>	<p>If the battery charging status falls below the min. SoC (e.g. 5% for BYD batteries), the battery sleep mode status is displayed and the battery is disconnected from the system. Sleep mode is exited as soon as the battery can be charged with excess power.</p> <p>If the SoC of the battery falls below the minimum allowed SoC, the battery receives a trickle charge of x% of the total battery capacity from the grid to protect the battery.</p> <p>Trickle charge:</p> <p>5% trickle charge the first time the SoC falls below the permitted value.</p> <p>10% trickle charge the second time the SoC falls below the permitted value.</p> <p>15% trickle charge the third time the SoC falls below the permitted value.</p> <p>Once sleep mode has been exited, the next trickle charge starts again with +5 %.</p>



1

2

3

4

5

6

7

8

9

10

11

12

13

14

15

4.7 Operational status (LEDs)

The LEDs on the front indicate the current operational status.

LEDs on the inverter

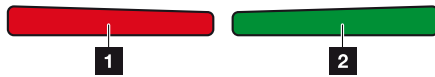
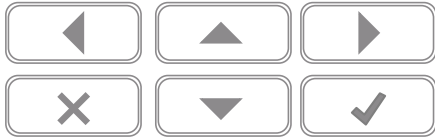

1 Red LED off:

There are no faults present.

Red LED flashing:

There is an event (warning) active.

Red LED lit up:

A fault has occurred. Remedial measures can be found in the "Event codes" chapter

☑ Event codes, Page 222.

2 Green LED off:

Inverter not feeding in.

Green LED flashing:

Inverter feeding in with limitation.

Green LED lit up:

The green LED signals the feed-in mode of the inverter.



1

2

3

4

5

6

7

8

9

10

11

12

13

14

15

4.8 Inverter menu structure

The screensaver is displayed after start-up or if no key has been pressed for a long time. Pressing any key activates the background lighting. The screensaver is exited by again pressing any key.

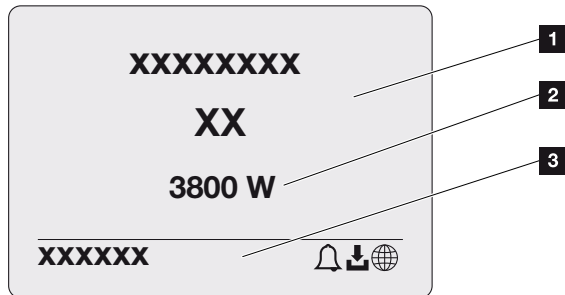

- 1 Inverter type with power class
- 2 Current AC power
- 3 Status line, alternates every 5 seconds with:
 - IP address (if configured)
 - Wifi status (if active)
 - Inverter status
 - Event code (if available)
 - Solar portal connection active (if configured)



1

2

3

4

5

6

7

8

9

10

11

12

13

14

15

Power flow diagram

When the screensaver is being displayed, the power flow diagram can be displayed by pressing another key. The diagram is a very clear representation of the current power flow in the house grid and includes the relevant power values. The arrows indicate the direction in which power is flowing at present.

Pressing the OK key exits the power flow diagram and switches to the inverter menu level.

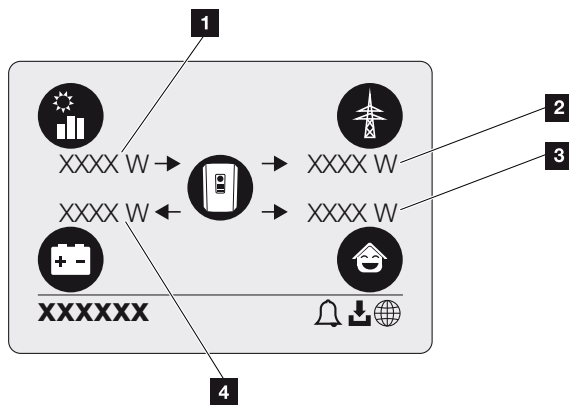

- 1 Indication of power being generated by the PV modules.
- 2 Indication of power, which is being fed into or drawn from the public grid.
- 3 Indication of power being consumed in the house.
- 4 Indication of power with which the battery is being charged or discharged.

i INFO

In order for the home consumption to be displayed, a compatible energy meter must be installed in the house network.

i INFO

The battery must be activated and connected before it can be displayed.

Overview of inverter menus



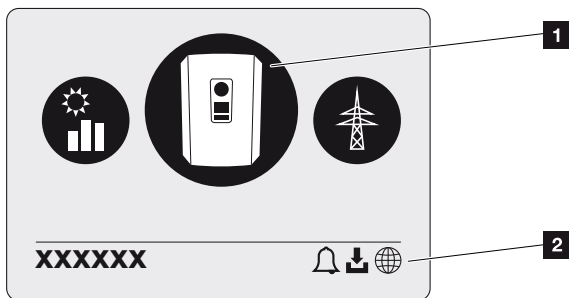

i INFO

The user interface/menu items in the inverter depend on the software installed in the inverter and may differ from the description here.



- 1 Active menu, selected using **ENTER**
- 2 Status line

The inverter provides the following menu items for querying statuses and configuring the inverter:

Symbol	Function
	Inverter settings
	Status query and information about the grid feed-in (AC side)
	House consumption status query
	Battery charge and discharge power status query
	PV generators status query (DC side)



1

2

3

4

5

6

7

8

9

10

11

12

13

14

15

The menus are listed individually on the following pages.



1

2

3

4

5

6

7

8

9

10

11

12

13

14

15

Menu Overview - Settings/information

Level 1	Level 2	Level 3	Level 4	
Settings/Information	Basic settings	Language	Select language	
		Inverter name	Enter name	
		Date/time	Set date/time	
	Communication	Network IPv4		Change IP and network parameters of the LAN interface.
				DNS server setting
		Wifi settings	Activate Wifi and select mode	
		Wifi IPv4	Change the Wifi module's IP settings.	
		Modbus SunSpec (TCP)	Activate Modbus SunSpec protocol	
	Solar portal	Portal		Select portal
				Activate or deactivate data export
	Device information	Article number	Article number	Article number
		Serial number	Serial number	Serial number
		Hardware	Hardware	Hardware version
		MC	MC	Main controller version
		IOC	IOC	Input-output controller version
		SW	SW	Software version
		National guideline	National guideline	Set national guideline
		Max. grid feed-in	Max. grid feed-in	Display of set limitation
	Extra options	Release options		Inputting an activation code, e.g. to connect a battery.
		Released options		Displays released options, which can be deactivated

Level 1	Level 2	Level 3	Level 4
	Service menu ¹	Service code input	Input for service code
		Fan test	Carry out a functional test on the fan
		Reset settings	Reset device to factory settings
		Event list ²	Shows the last 10 events with explanation
		Energy management	Input for max. feed-in capacity (default: max. inverter power)
		Select the energy meter connected to the inverter and the installation position ³	
		Reset national guideline ³	Reset the country setting
	Update	System update	Configure system update selection (automatic, manual or notification of updates)
Check for updates		Check for new software updates and install if available.	

¹ After entering the service code, additional menu items appear for configuring the inverter. The code can be requested for installers from the service team.

² A maximum of 10 events are displayed. Information about events can be found in the "Event codes" chapter.

³ Only possible with service code entry.



1

2

3

4

5

6

7

8

9

10

11

12

13

14

15

Menu Overview – AC side (grid)

Level 1	Level 2	Level 3
AC side (grid)	Current AC power	Shows the voltage (U), current (I) and power (P) per phase, which is being fed into the house grid.
	Yield overview	Shows the energy per day, month, year, total in Wh, kWh or MWh that has been fed into the house grid.
	Grid parameter	Shows the current grid frequency, the set power factor (cos phi), the current power and, if configured, the set power curtailment, e.g. to 70 %.

Menu Overview – House consumption

INFO

In order for the home consumption to be displayed, a compatible energy meter must be installed in the house network.

Level 1	Level 2	Level 3
Home consumption menu	Consumption	Shows the current consumption in the house and the source that covers it.
	Daily consumption	Shows the daily consumption in the house and the source that has covered it.
	Monthly consumption	Shows the monthly consumption in the house and the source that has covered it.



1

2

3

4

5

6

7

8

9

10

11

12

13

14

15

Level 1	Level 2	Level 3
	Degree of self-sufficiency	Degree of self-sufficiency shows self-consumption in relation to home consumption. This states the percentage of energy consumed in the building that has been covered by the PV/battery energy generated.
	Self-consumption rate	The self-consumption rate reflects the self-consumption in relation to the inverter's total generated power. This states the percentage of generated energy used for self-consumption.

Menu Overview – PV generator (DC side)

Level 1	Level 2	Level 3
PV generator menu (DC side)	Current DC power	Shows the voltage (U), current (I) and power (P) per DC input ⁴

Menu Overview – Battery

i INFO

The battery must be activated and connected before it can be displayed.

Level 1	Level 2	Level 3
Battery menu	Battery status	Shows the current charging status, voltage, charge or discharge current and number of battery cycles.

⁴ This is displayed depending on the model or use of the 3rd DC input. If there is a battery connected to DC3, no values are displayed for this.



1

2

3

4

5

6

7

8

9

10

11

12

13

14

15

4.9 Description of inverter menus

The menus are listed individually on the following pages.

Menu – Settings/information

The inverter and additional components (e.g. energy meter) are configured under "Settings/information".

■ Basic setting

Setting the general parameters.

Parameter	Explanation
Language	Selection of menu language
Inverter name	Enter the inverter name. The characters a–z, A–Z, 0–9 and "-" are permitted for the name change. Spaces or special characters are not possible. The browser connection to the Webserver can be established with the new name following the name change. It is still possible to gain access with the serial number.
Date/time	Enter the time and date. Setting the time zone Activate/deactivate or automatic determination of time. The NTP server can be configured via the Webserver.

■ Communication

Set the communication parameters for the inverter's Ethernet connection.



INFO

The "Automatic" option is activated by default. This means that the inverter acquires its IP address from a DHCP server or automatically generates an IP address.

If the inverter is not allocated an automatic IP address through a DHCP server, the inverter can be configured using the item **Manual**.

The data necessary for configuration, such as IP, router addresses etc., can be found on your router/gateway.



1

2

3

4

5

6

7

8

9

10

11

12

13

14

15

Parameter	Explanation
Network IPv4	<p>Activate the network protocol and configure the network interface (Ethernet) for the inverter.</p> <p>The Automatic option is activated by default.</p> <p>If configuring manually, the corresponding parameter values should be entered.</p> <p>Setting the DNS server:</p> <p>The Automatic option is activated by default.</p> <p>If configuring manually, the corresponding parameter values should be entered.</p>
Wifi settings	<p>Setting the communication parameters for the inverter's Wifi connection.</p> <p>The inverter offers various options here.</p> <p>Wifi mode: Wifi off</p> <p>The inverter's Wifi interface is deactivated.</p> <p>Wifi mode: Access point</p> <p>The inverter offers a Wifi access point. This can be used, for example, to log a PC or smartphone on to the inverter to configure or monitor the inverter.</p> <p>SSID: Displays the inverter's SSID. The SSID is KOSTAL_<serial number>.</p> <p>SSID visible: The SSID is visible to other devices in the Wifi search.</p> <p>Encryption: Select Wifi encryption.</p> <p>Password: Enter a password. By default, this is the article number found on the type plate.</p> <p>Radio channel: Select the radio channel. By default, this should be set to "Auto".</p> <p>QR code: Displays the data as a QR code. Scan the code with a smartphone and connect to the inverter.</p>



1

2

3

4

5

6

7

8

9

10

11

12

13

14

15

Parameter	Explanation
	<p>Wifi mode: Client</p> <p>The inverter is a Wifi client and can connect to a Wifi gateway in the local home network. In that case, a LAN connection no longer needs to be set up.</p> <p>Find networks: Press the button to search for available networks in the vicinity of the inverter. The available networks in the vicinity of the inverter are then displayed. Select your local network to which the inverter should connect.</p> <p>SSID: If the network you are looking for is not displayed, this may be because it has been configured to not be visible. You can then enter the network name yourself here.</p>
Wifi IPv4	<p>Configuration of the inverter's Wifi network interface. The Webserver on the inverter can be accessed via this IP address if there is a Wifi connection to the inverter.</p> <p>The Automatic option is activated by default.</p> <p>If configuring manually, the corresponding parameter values should be entered.</p> <p>Setting the DNS server:</p> <p>The Automatic option is activated by default.</p> <p>If configuring manually, the corresponding parameter values should be entered.</p>
Modbus/SunSpec (TCP)	Activates the SunSpec (TCP) protocol

■ **Solar portal**

Input for the solar portal configuration. If a solar portal is to be used, the log data and events are sent to the solar portal.

Parameter	Explanation
Solar portal	Selection of solar portal.
Activate	Activate to start sending to a solar portal.

■ **Device information**

Shows information about the versions installed on the inverter.



1

2

3

4

5

6

7

8

9

10

11

12

13

14

15

Parameter	Explanation
Article number	Article number of the inverter
Serial number	Inverter serial number
Hardware	Hardware version
MC	Main controller version
IOC	Input-output controller version
SW	Software version
National guideline	Shows the national guideline selected for the inverter.
Max. output power	Shows the inverter's maximum output power.

■ Extra options

This function can be used to release additional options/functions for the inverter.

Parameter	Explanation
Release option	Enter an activation code, e.g. to connect a battery. This must be purchased in advance from the KOSTAL Solar Webshop.
Released options	Overview of options currently released in the inverter



INFO

The activation code can be purchased from the KOSTAL Solar Webshop.

The following link will take you to the shop: shop.kostal-solar-electric.com

■ Service menu

The installer or an experienced user can use the inverter's service menu to implement settings on the inverter.



INFO

The service menu items depend on the inverter software installed and may differ from the description here.

Some menu items can also be run without a service password. However, these items should only be run by experienced users because otherwise under certain circumstances the inverter may no longer function perfectly.

For the complete service menu to be displayed, the installer must request a code from the inverter manufacturer's service team.

The code is entered by going to the **Service code input** menu item.

Once the service code has been entered and confirmed, additional service menu entries appear.

Parameter	Explanation
Service code input	Input of service code and enabling of additional menu items.
Fan test	Starting the fan test
Reset settings	Reset inverter to factory settings. This resets the following settings: Language, inverter name, date/time, network settings, protocol, log data and solar portal.
Event list	Shows the last 10 events with date. Selecting an event and pressing the "OK" key displays a detailed view of the event.
Energy management	<ul style="list-style-type: none"> ■ Maximum grid feed-in Set the maximum feed-in capacity. Requirements relating to this are generally specified by the energy supply company (e.g. a limitation to 70 %). The inverter's max. power serves as the default. NOTE! Incorrect settings due to lack of expertise. The system operator is responsible for correctly setting the active power limitation. Your grid operator will provide details of the permissible active power for your system. We recommend that the installer configures all the settings. ■ Energy meter (only available once a service code has been entered) Select the installed energy meter in the building services. ■ Sensor position Select the position of the energy meter in the building services (grid connection or house consumption).
Reset national guideline (only available once a service code has been entered)	<p>Reset the country setting. After resetting, the inverter starts the commissioning wizard after a restart.</p> <p>NOTE! Should the inverter not restart automatically, switch it off using the DC switch and also the AC line circuit breaker. Wait 10 seconds and then restart in reverse order.</p>



■ **Update menu**

The update menu can be used to set the software update method or to install updates manually.



INFO

You can find the latest update in the download area for the product on our website at www.kostal-solar-electric.com

Parameter	Explanation
System update	<p>Select the inverter's system update method (software update).</p> <ul style="list-style-type: none"> ■ Manual updates The update must be carried out manually. ■ Find out about updates The inverter checks at regular intervals whether new software is available. A software update symbol appears on the inverter or in the Webserver if there is an update. The installation must then be started manually. ■ Automatic updates The inverter checks at regular intervals whether new software is available and then installs it automatically. This setting is recommended.
Look for updates	The system looks for current updates from the manufacturer. If a new update is available, it is displayed and can then be installed.

Menu – AC side (grid)

Shows the current values of the AC side.

■ **Current AC power**

Shows the current performance data of the grid side (AC) and how this is distributed to the phases.

Parameter	Explanation
Phase 1	Shows the voltage, current and power that is being fed into or taken from the public grid.
Phase 2	



1

2

3

4

5

6

7

8

9

10

11

12

13

14

15

Parameter	Explanation
Phase 3	

■ **Yield overview**

Indicates the energy generated by the PV generators.

Parameter	Explanation
Day	Shows the yield values for the current day (from 00 to 24 hours).
Month	Shows all yield values for the current month (from day 1 to day 31).
Year	Shows all yield values for the current year (from 1 Jan. to 31 Dec.).
Total	Shows the total yield since commissioning.

■ **Grid parameter**

Shows the inverter's current grid parameters.

Parameter	Explanation
Current grid frequency [Hz]	Shows the grid frequency.
Current cos phi	Indicates the current power factor (cos phi).
Current power	Shows how much power the inverter is feeding into the house grid
Limitation on [W]	Shows the current power curtailment setting.

Menu – House consumption

Shows the home consumption and from which sources the home consumption is being covered (PV generator, battery or public grid).



INFO

In order for the home consumption to be displayed, a compatible energy meter must be installed in the house network.



1

2

3

4

5

6

7

8

9

10

11

12

13

14

15

**INFO**

A list of **approved energy meters** and their purpose is available in the download area for the product on our website at www.kostal-solar-electric.com

- **Current home consump.**

Parameter	Explanation
Consumption	Current home consump.
From PV	Share of home consumption being covered by PV.
From grid	Share of home consumption being covered by the public grid.
From battery	Share of home consumption being covered from the battery.

- **Daily house consumption**

Parameter	Explanation
Consumption	Home consumption of current day
From PV	Share of home consumption that has been covered by PV.
From grid	Share of home consumption that has been covered by the public grid.
From battery	Share of home consumption that has been covered from the battery.

- **Monthly house consumption**

Parameter	Explanation
Consumption	Home consumption of current month
From PV	Share of home consumption that has been covered by PV.
From grid	Share of home consumption that has been covered by the public grid.
From battery	Share of home consumption that has been covered from the battery.

- **Degree of self-sufficiency**



1

2

3

4

5

6

7

8

9

10

11

12

13

14

15

The degree of self-sufficiency indicates what percentage of the house's total power requirement is covered by self-generated PV energy. The higher the value, the less energy has had to be purchased from the energy supplier.

Parameter	Explanation
Day	Display for current day (from 00 to 24 hours)
Month	Display for current month (from day 1 to day 31)
Year	Display for current year (from 1 Jan. to 31 Dec.)
Total	Display for since initial commissioning

■ **Self-consumption rate**

The self-consumption rate shows the relationship between self-consumption and the total energy generated using the PV generators.

Parameter	Explanation
Day	Display for current day (from 00 to 24 hours)
Month	Display for current month (from day 1 to day 31)
Year	Display for current year (from 1 Jan. to 31 Dec.)
Total	Display for since initial commissioning

Menu – PV generator (DC side)

Shows the current values of the PV generators.

■ **Current DC power**

Shows the generated voltage, current and energy of the PV generators per DC input.

Parameter	Explanation
DC1	Shows the generated voltage, current and power of the PV generators for DC input 1
DC2	Shows the generated voltage, current and power of the PV generators for DC input 2



1

2

3

4

5

6

7

8

9

10

11

12

13

14

15

Parameter	Explanation
DC3	Shows the generated voltage, current and power of the PV generators for DC input 3 The values are only displayed if the inverter has a DC input 3 and if this has been configured as a PV input. If there is a battery connected to DC input 3, this is not shown.

Menu – Battery

Displays the current battery values.

■ Battery status

If a battery is connected to the PLENTICORE plus G2, the current battery values are displayed here.

Parameter	Explanation
Charging status	Shows the battery's charging status (only when battery is connected).
Voltage	Shows the battery's voltage.
Charge / discharge current	A charging shows that the battery is being charged. A discharge shows that the battery is being discharged.
Number of cycles	Shows the battery's charging cycles.



1

2

3

4

5

6

7

8

9

10

11

12

13

14

15

5. Connection types

5.1	Connecting the inverter/computer	127
5.2	Settings on the computer	128
5.3	Connecting the inverter/computer	129
5.4	Disconnecting the inverter from the computer	131
5.5	Connection via KOSTAL Solar App	132



1

2

3

4

5

6

7

8

9

10

11

12

13

14

15

5.1 Connecting the inverter/computer

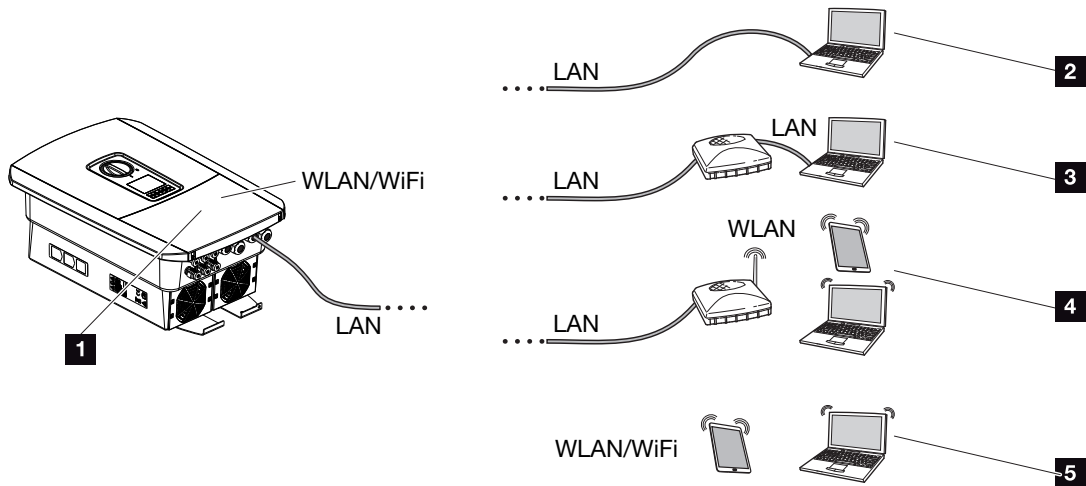

- 1 Inverter with LAN/Wifi interface
- 1 Inverter with LAN interface
- 2 Direct connection via LAN (only with manual IP configuration)
- 3 LAN connection via switch/hub/router
- 4 Wifi connection via Wifi router
- 5 Direct connection via Wifi with the inverter

The inverter can be contacted via a computer or tablet using various types of connection to configure it or retrieve data. Several settings should be noted here. These are explained in more detail on the following pages.

i INFO

If the inverter is to be accessed via the Internet, this shouldn't take place using unencrypted HTTP access (port 80).

Instead, preference should be given to encrypted access via HTTPS (port 443) and a VPN connection.

For settings relating to the router or Internet, please contact the provider of the router, your provider or a network specialist.



5.2 Settings on the computer

The items listed below relate to the Windows 10 operating system.

- In the computer's Internet protocol (TCP/IP), the options ***Automatically acquire IP address*** and ***Automatically acquire DNS server address*** must be activated. (If the computer can already access the network in which the inverter is located, these settings are no longer required.)

You can go to the Internet protocol (TCP/IP) settings via the control panel:

Control Panel > Network and Sharing Center > Change Adapter Settings.

Right-click on ***LAN connection > Properties > Select "Internet protocol (TCP/IPv4)" > Properties.***

- In the computer's LAN settings, the option "Use proxy server for LAN" must be deactivated.

You can reach the LAN settings via the control panel:

Control Panel > Internet options > Tab: Connections > LAN settings.



1

2

3

4

5

6

7

8

9

10

11

12

13

14

15

5.3 Connecting the inverter/computer

This variant is mainly used when configuring using the Webserver on site.



INFO

Use a patch cable of category 5 (Cat 5e) or better with a length of max. 100 m.

1. De-energise the inverter's terminal compartment.



DANGER

Risk of death due to electrical shock and discharge!

De-energise device and secure against being switched on again. **De-energising the inverter, Page 99**

2. Remove the cover.
3. Remove the terminal compartment's cover.

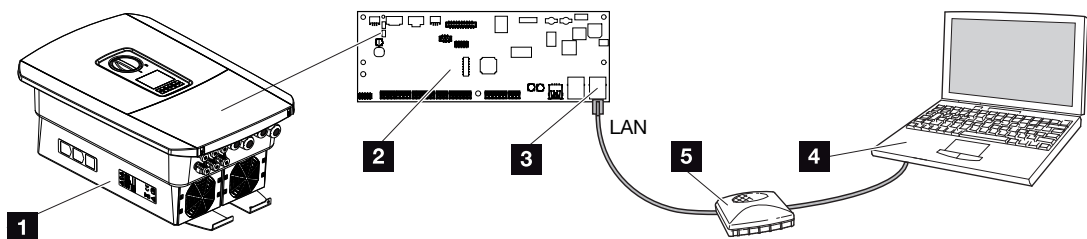

- 1 Connect device and computer with Ethernet cable
- 2 Smart Communication Board with LAN interface
- 3 Ethernet cable (LAN)
- 4 PC
- 5 Router
4. Insert Ethernet cable into the inverter and seal with sealing ring and union nut. Tighten union nut to the prescribed torque. Torque: 8 Nm (M25).
5. Connect Ethernet cable to LAN interface of Smart Communication Board.



1

2

3

4

5

6

7

8

9

10

11

12

13

14

15

**INFO**

If the inverter is connected directly to the PC and has not yet been given its own IP address via a DHCP server, an IP address must be configured manually for the inverter in the inverter. This can then be entered into the browser's address bar on the PC to access the Webserver.

Connecting the Ethernet cable to a router integrates the inverter into your own network and the inverter can then be contacted by all computers incorporated in the same network.

6. Connect Ethernet cable to a router or computer.
7. Close cover of terminal compartment and inverter (2.0 Nm).
8. Activate fuses and DC switch.
- ✓ The inverter is connected to the computer.



1

2

3

4

5

6

7

8

9

10

11

12

13

14

15

5.4 Disconnecting the inverter from the computer

1. De-energise the inverter's terminal compartment.



DANGER

Risk of death due to electrical shock and discharge!

De-energise device and secure against being switched on again. **De-energising the inverter, Page 99**

2. Remove cover of inverter and terminal compartment.
3. Unplug the Ethernet cable from the inverter and computer.



INFO

Leave the Ethernet cable connected to the inverter. This makes it possible to easily carry out further queries or setting configurations on the inverter.

If connecting through a router, for example, there is no need to remove the connection.

4. Close the inverter cover.
 5. Activate fuses and DC switch.
- ✓ The inverter is once again in operation.



1

2

3

4

5

6

7

8

9

10

11

12

13

14

15

5.5 Connection via KOSTAL Solar App

The free KOSTAL Solar App offers you professional monitoring of your photovoltaic system. You can use the KOSTAL Solar App to simply and easily access all functions on your smartphone or tablet at any time.

To set up and use the app, you will need access to the KOSTAL Solar Portal and to have an inverter set up there. To log in to the app, you will need to use the same access data as for the KOSTAL Solar Portal.

You can use the KOSTAL Solar App to easily monitor your photovoltaic system and to display relevant system data both at home and when you are out and about. It allows you to access the consumption and generation data over various time periods, such as day, week, month and year, and to view your photovoltaic system's historical data. This means that with the KOSTAL Solar App you are always up to date.

Download the free KOSTAL Solar App today and benefit from new and advanced functionalities.





6. WebsERVER

- 6.1 The WebsERVER..... 134
- 6.2 Accessing the WebsERVER..... 137
- 6.3 WebsERVER – menu structure 139
- 6.4 WebsERVER– menus..... 144

6.1 The Webserver

Webserver – start screen

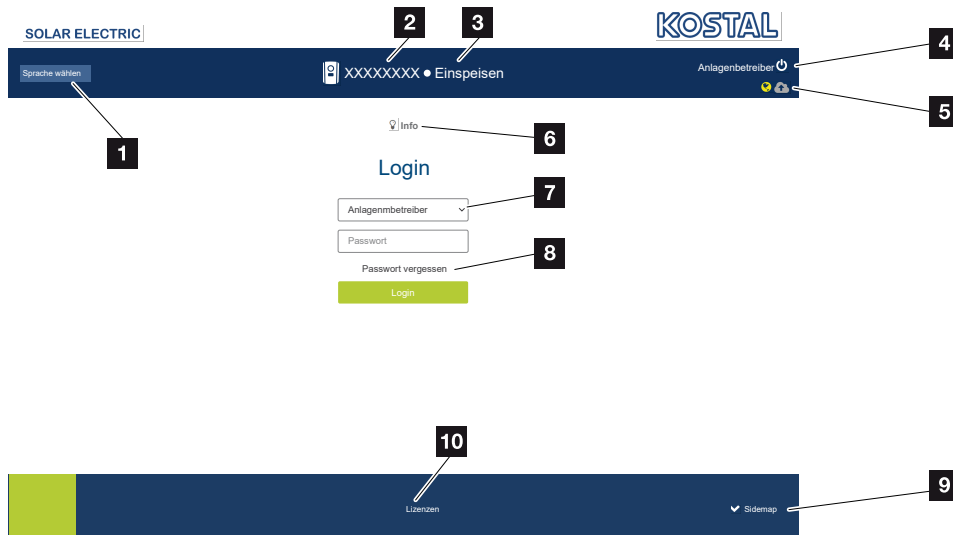

- 1 Language selection
- 2 Name of the inverter
- 3 Inverter status message
- 4 Webserver login/logout
- 5 Status messages

Globe symbol: Solar portal connection

Software update symbol: Software update available

- 6 Retrieval of device information
- 7 Login as plant owner or installer
- 8 With the **Forgotten password** button the user can assign a new password for the Webserver or create a new password generally for logging in for the first time.
- 9 Access to sitemap
- 10 Licence information

The Webserver forms the graphic interface between the inverter and user. Even if you don't log in, you can find information about your PV system here, including, for example, device information and the current status of the inverter. Go to **Login** to log in as **Plant owner** or **Installer**.

! INFO

To log in as a plant owner, you need a password, which has to be generated for the first login by clicking on **Forgotten password**. For this, you also need the master key from the type plate.

To log in as an installer, you need the master key from the inverter's type plate and your service code, which can be requested from our service team. **📄 Type plate, Page 235**

Webserver– menus

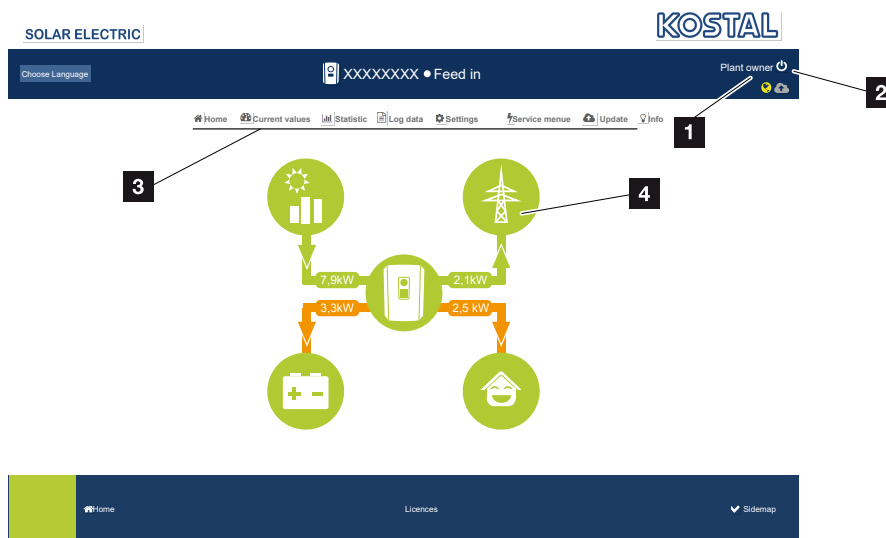

- 1 User logged in
- 2 Logout from the Webserver
- 3 Inverter menus
- 4 Energy flow diagram

Once you have logged in as plant owner or installer, you can choose from various menu items.

i INFO

Depending on user role (installer or plant owner), different menu items can be accessed. Due to different software versions, the Webserver may display different menu items to those described here.

The Webserver allows the user to view key information, current values, events and inverter versions.



1

2

3

4

5

6

7

8

9

10

11

12

13

14

15

The **Statistics** provide an overview of the yield.

The **Settings** and **Service menu** allow the inverter to be configured quickly and easily. More information about the inverter can be found under **Log data**.

On the next few pages, you will find details of how to log in to the Webserver and explanations of individual menu items.



6.2 Accessing the Webserver

The Webserver is accessed on the inverter from a computer using a web browser (e.g. Microsoft Edge, Internet Explorer, Firefox or Google Chrome). Both devices must be on the same network.

INFO

Any device (e.g. a tablet PC) that has a browser can be used to access the Webserver.

Information about the connection and settings on the computer.  **Connection types, Page 126**

A user can log in to the Webserver as a **Plant owner** or **Installer** using **Login**.

To log in to the Webserver as an installer, you will need a personal service code and the master key for the inverter (can be found on the inverter's type plate). After logging in, the installer can access advanced setting options, which are not available to the normal plant owner. These settings require specialist knowledge.

INFO

You can request a service code from our service team.  **Warranty and service, Page 237**

Use **Logout** to log out of the Webserver.



Logging in to the Webserver

Launch an Internet browser.

1. Enter the inverter's IP address in the browser's address bar and confirm with **ENTER**.



INFO

The IP address is shown alternately in the inverter display or can be queried in the inverter menu.

- The Webserver is called up.
2. As the plant owner, log in with your password.

If you want to log in as an installer, enter the following data:

Master key: Master key from the type plate

Service code: Installer service code

Confirm the danger notice and disclaimer.



IMPORTANT INFORMATION

To log in for the first time as the plant owner, you first have to have a password. You can get one by selecting **Forgotten password**. In the following menu, enter the master key and a new password. You will find the master key on the inverter's type plate.

The password must comprise at least 8 characters and include the following characters:
a-z, A-Z, 0-9

Should you forget your password, it can be re-assigned in the same way.

- ✓ The Webserver's menu opens.

Configuring settings in the Webserver

After logging in, the required settings can be implemented on the inverter via the Webserver or the inverter's values can be queried.

6.3 WebsERVER – menu structure

INFO

Depending on user role (installer or plant owner), different menu items can be accessed. Due to different software versions, the WebsERVER may display different menu items to those described here.

"Home" menu

	Level 1	Level 2	Level 3
	Home	Display of power flow diagram	-

"Current values" menu

	Level 1	Level 2	Level 3
	Current values	PV generator	Shows voltage, current, power for each DC input
		Inverter	Shows inverter status and active events
		House consumption	Shows the home consumption and the sources from which the home consumption is being covered (solar generator, battery or public grid).
		Grid	Shows voltage, current, power per phase and the grid parameters
		Battery	If a battery is connected to the inverter, the current battery values are displayed here

"Statistics" menu

	Level 1	Level 2	Level 3
	Statistics	Daily yield	Shows yield for current day
		Monthly yield	Shows yield for current month
		Annual yield	Shows yield for current year
		Total yield	Shows total yield

"Log data" menu

	Level 1	Level 2	Level 3
	Log data	Log data	Download log data from inverter

"Settings" menu

	Level 1	Level 2	Level 3
	Settings	Basic setting	Assign inverter name
			Set date and time
			Assign new password
		Network	Set up LAN network settings (TCP/IP)
			Set up Wifi network settings.
		Modbus/SunSpec (TCP)	Activate inverter's Modbus/SunSpec (TCP) protocol.
Solar portal	Selection of solar portal. Activate/deactivate the transfer of data to the portal and connection test.		
Reset system owner settings	The values for the basic settings, network, Modbus/SunSpec and solar portal are reset to the factory settings	<p>NOTE! The option "Automatically acquire IP address" is activated for the network by default. This means that the inverter obtains its IP address from a DHCP server. In this case, the same IP address is usually assigned to the inverter via the DHCP server.</p>	

"Service– general" menu

	Level 1	Level 2	Level 3
	Service menu	Energy management ⁵	Select the installed energy meter and the installation position. Set the limitation of the feed-in capacity (configurable without service code). Activate the function for receiving control signals from a ripple control receiver.
		Generator settings	Activate shadow management per MPP input or use of external module controls.
		Battery settings	Select battery type, battery control, battery use from a certain power level, activate intelligent battery control and time-controlled battery use. Activate the storage of excess AC energy from local generation , located in the same house grid, in a connected battery.
		External hardware settings	Set compatibility with residual current devices/RCD type A circuit breakers.
		Digital inputs ⁵	Set function of digital inputs (e.g. operating mode of ripple control receiver and activate function for forwarding of control signals or for external battery control).
		CEI inputs	Activate the CEI input (terminal X403). The switchable shutdown limits must be configured under "Grid and system protection".
		Switched output	Set the functions of the 4 switched outputs (e.g. for load control, for a heat pump with SG Ready label, events).
		Extra option	Release extra option via activation code (e.g. battery use on DC3).

⁵ Can only be changed with service code

Menu "Service – grid parameterization"

	Level 1	Level 2	Level 3
	Service menu	Parameterization report	Overview of parameters set in the inverter
		Reactive power settings ⁶	Reactive power configuration
		Start-up ramp ⁶	Configuration of start-up ramp if there is a start-up or grid error
		LVRT/HVRT ⁶	LVRT/HVRT
		P(f) ⁶	Configuration of power reduction in the case of overfrequency P(f)
		P(U) ⁶	Configuration of power reduction in the case of overvoltage P(U)1
		Settling time ⁶	Configuration of the settling time. Setting the settling time with external control, reactive power or active power by means of ripple control receiver or Modbus
		Grid and system protection ⁶	Grid and system protection. Configuration of the grid and system protection: Voltage L-N, frequency, start-up voltage, start-up frequency, start-up waiting time for start, start-up waiting time for grid error
Grid and system protection self-test	Self-test for grid and system protection Performs a self-test and outputs the result for it		

"Update" menu

	Level 1	Level 2	Level 3
	Update	Update	Perform inverter software update. Configure system update (automatic, manual, find out about updates).

⁶ Can only be changed with service code

"Info" menu

	Level 1	Level 2	Level 3
	Info	Device information	Shows device and network information as well as events that are pending in the inverter.



6.4 Webserver– menus

The following menus are available to the user in the Webserver. A more detailed description of the individual items is provided on the following pages:

- **Home**

Shows power flow diagram

- **Current values**

Using various statistics, the user can display the current values for daily, monthly, annual and total yield. Detailed information can be displayed by expanding the statistics.

- **Statistics**

Shows information about the inverter's yield data for daily, monthly, annual or total time periods.

- **Log data**

Here the inverter's log data can be downloaded in full or for a limited time period.

- **Settings**

These menu items can be used to configure the basic settings for the inverter (e.g. inverter name, network settings, specifications relating to remuneration, retrieval of log data).

- **Service menu**

These menu items can be used by the installer to configure the inverter's hardware (e.g. active power reduction or special grid settings which have been specified by the energy provider).

- **Update**

This menu item can be used to update the inverter via a software update and to configure the system update method, e.g. to automatic updates.

- **Info**

On the Info page the user can view events pending in the inverter and the inverter's installed versions (e.g. software, MC, IOC, hardware). This information can also be viewed without logging into the Webserver.



1

2

3

4

5

6

7

8

9

10

11

12

13

14

15

Webserver menu – Home

■ Home

Shows the power flow diagram. The directions of flow for the energy to and from the inverter are shown. The values indicate the power currently present.

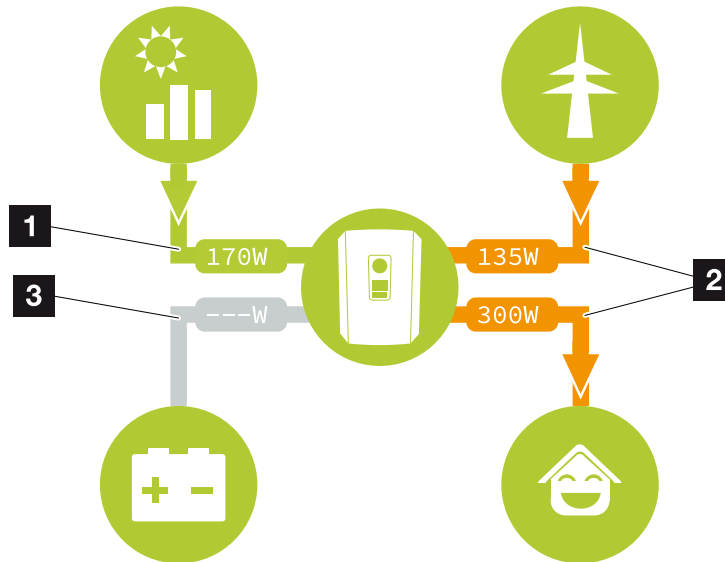

- 1 Green: Energy is being supplied
- 2 Orange: Energy is being purchased/consumed
- 3 Grey: No energy flow



Webserver menu – Current values

Menu items to display the current energy values of the AC and DC side.

■ PV generator

Shows the generated voltage, current and energy of the PV generators per DC input.

Parameter	Explanation
<i>DC input x</i>	Shows the generated voltage, current and power of the PV generators per DC input.

■ Inverter

Shows the current status of the inverter, current performance data of the grid side (AC) and how the energy is distributed to the phases.

Parameter	Explanation
<i>Status</i>	Inverter operational status. For more information, see ☑ Operational status (display), Page 103
<i>Digital inputs</i>	Signal status of digital interface terminal for ripple control receiver (input 1-4). The display shows whether the feed-in is currently limited, e.g. by the energy supplier or by an external battery management system. Settings, e.g. for user-defined active/reactive power reduction, can be made by going to Service menu > Digital inputs . ☑ Why active power control?, Page 190
<i>Output power</i>	Shows how much inverter power is being fed into the home network.
<i>Grid frequency</i>	Shows the current grid frequency
<i>Cos phi</i>	Indicates the current power factor (cos phi)
<i>Limitation on</i>	Shows the current power curtailment setting. If an energy meter (e.g. a KOSTAL Smart Energy Meter) is fitted in the house grid and power limitation is set, the active power is dynamically limited taking home consumption into consideration. This means that in addition to the set power curtailment, the home consumption is added up to the maximum power limit of the inverter.
<i>Phase x</i>	Shows the power values per phase (x = 1, 2 or 3)



1

2

3

4

5

6

7

8

9

10

11

12

13

14

15

■ House consumption

Display of the current home consumption and the sources from which home consumption is covered.



INFO

In a device network comprising multiple KOSTAL inverters, the data is merged in the portal. Correct and complete visualisation takes place exclusively in the KOSTAL Solar Portal and in the KOSTAL Solar App and not in the individual inverter.

Parameter	Explanation
Current home consumption covered by	Shows the home consumption and the source from which it is currently covered.

■ Grid

Shows the current performance data of the grid side (AC).

Parameter	Explanation
Grid	<p>Feed-in: PV energy is fed into the public grid.</p> <p>Consumption: Energy is purchased from the public grid to cover home consumption.</p>

■ Battery

If a battery is connected to the inverter (only possible if DC3 has been released), the current battery values are displayed.



INFO

If all values are at zero, the battery is in sleep mode. You can check the status of the battery by going to **Current values > Inverter**.

Parameter	Explanation
Status	<p>Charge: The battery is being charged.</p> <p>Discharge: Energy is being drawn from the battery.</p>

Parameter	Explanation
Battery status	<p>Normal: Normal state</p> <p>Equalisation charge: The battery is charged from the grid for protection.</p> <p>Deep discharge protection: The battery is charged from the grid to protect against deep discharge.</p> <p>Ext. battery control: The battery is regulated via an external control system.</p> <p>Battery sleep mode: If the battery charging status falls below the configured minimum SoC, this status is displayed and the battery is disconnected from the system. As soon as sufficient excess PV power is available, sleep mode is cancelled and the battery is switched on again.</p> <p>Service charging: Service charging can only be started by the installer.</p>
Voltage	Shows the battery's charge/discharge voltage.
Current	Shows the battery's charge/discharge current.
Power	Shows the battery's charge/discharge power.
Charging status	Shows the battery's charging status in %.
Charging cycles	Shows the battery's charging cycles.

WebsERVER menu – Statistics

Shows the yield for the day, month, year and total.

■ Yield statistics

Displays the yield/consumption values.

Parameter	Explanation
Day	Shows the yield/consumption values for the current day.
Month	Shows the yield/consumption values for the current month.
Year	Shows the yield/consumption values for the current year.
Total	Shows all yield/consumption values that have accumulated in the inverter.

Parameter	Explanation
Diagram	<p>Self-consumption: Displays the self-consumption of all of the energy produced.</p> <p>Degree of self-sufficiency: The degree of self-sufficiency indicates what percentage of the house's total power requirement is covered by self-generated PV energy. The higher the value, the less energy has had to be purchased from the energy supplier.</p>
CO2 saving	Shows the purely arithmetical CO2 saving that has been saved by the PV energy generated.
House consumption	<p>Shows the home consumption.</p> <p>From PV: Shows how much PV energy has been used for home consumption.</p> <p>From grid: Shows how much energy has been obtained from the public grid.</p> <p>From battery: Shows how much energy from the battery has been used for home consumption.</p>

Websver menu – Log data

Access the log data from the inverter.

INFO

The data is saved in the inverter for around 365 days. When the internal memory is full, the oldest data will be overwritten.

Parameter	Explanation
Log data download	<p>Restricted time period: Download a selected time period of log data from the inverter (max. 100 days).</p>

The log data of the inverter can be downloaded as a file (logData.csv). The data in the file is in CSV format and can be viewed with any spreadsheet programme (e.g. Excel).

For more information, see  **The log data, Page 205.**

The data is saved on your hard drive. After saving, this data can be displayed and further processed.

i INFO

If the inverter is not connected to a solar portal, the log data should be regularly backed up.

WebsERVER menu – Settings

In Settings you can configure the inverter and the external components (e.g. ripple control receiver etc.).

■ **Basic settings**

Set the general parameters of the inverter.

Inverter name

Set the general parameters of the inverter.

Parameter	Explanation
<i>Inverter name</i>	Input for inverter name (max. 63 characters). The following characters are permitted: a–z, A–Z, 0–9 and "-". Spaces or special characters are not possible. Following the name change the browser connection to the WebsERVER can be established with the new name or can continue using the IP address.

■ **Time setting**

Set time/date or select a time server.

Parameter	Explanation
<i>Date and time</i>	Input for time/date. The time can be taken from the PC.
<i>Time zone</i>	Setting the time zone
<i>Use time server (NTP)</i>	Activate/deactivate a time server (NTP server). After activation, the time from the time server is used. By using the NTP server, the switch between summer and winter time is also performed automatically.
<i>NTP server</i>	Input for IP address or name of NTP server (Network Time Protocol). Other, alternative NTP servers can be added via Plus (+). There are numerous free NTP servers on the network which can be used here.

■ **Change password**

Change Webserver password.

Parameter	Explanation
Change password	Change Webserver password. The password must comprise at least 8 characters and include the following characters: lower-case letters (a-z), upper-case letters (A-Z) and numbers (0-9).

■ **Network**

Set the inverter's network communication parameters for LAN.

Parameter	Explanation
Automatically acquire IPv4 address	If the box is ticked, the IP address is generated automatically by a DHCP server. Most routers provide a DHCP server as standard. NOTE! The option "Automatically acquire IP address" is activated by default. This means that the inverter obtains its IP address from a DHCP server.
IPv4 address (only with manual configuration)	Enter the IP address of the inverter NOTE! If the inverter is not allocated an IP address automatically through a DHCP server, the inverter can be configured manually. NOTE! The data necessary for configuration, such as IP, subnet mask, router and DNS addresses, can be found on your router/gateway.
Subnet mask (only with manual configuration)	Enter the subnet mask, e.g. 255.255.255.0
Router/gateway (only with manual configuration)	Enter the IP address of the router
DNS server 1 (only with manual configuration)	Enter the IP address of the DNS server (Domain Name System)



1

2

3

4

5

6

7

8

9

10

11

12

13

14

15

Parameter	Explanation
DNS server 2 (only with manual configuration)	Enter the IP address of the backup DNS server (Domain Name System)

Set the inverter's network communication parameters for Wifi.

Parameter	Function
Wifi settings	<p>Setting the communication parameters for the inverter's Wifi connection.</p> <p>The inverter offers various options here.</p> <p>Wifi mode: Wifi off The inverter's Wifi interface is deactivated.</p> <p>Wifi mode: Access point The inverter offers a Wifi access point. This can be used, for example, to log a PC or smartphone on to the inverter to configure or monitor the inverter.</p> <p>SSID: Displays the inverter's SSID. The SSID is KOSTAL_<serial number>.</p> <p>SSID visible: The SSID is visible to other devices in the Wifi search.</p> <p>Encryption: Select Wifi encryption.</p> <p>Password: Enter a password. By default, this is the article number found on the type plate.</p> <p>Radio channel: Select the radio channel. By default, this should be set to "Auto".</p> <p>QR code: Displays the data as a QR code. Scan the code with a smartphone and connect to the inverter.</p>

Parameter	Function
	<p>Wifi mode: Client</p> <p>The inverter is a Wifi client and can connect to a Wifi gateway in the local home network. In that case, a LAN connection no longer needs to be set up.</p> <p>Find networks: Press the button to search for available networks in the vicinity of the inverter. The available networks in the vicinity of the inverter are then displayed. Select your local network to which the inverter should connect.</p> <p>SSID: If the network you are looking for is not displayed, this may be because it has been configured to not be visible. You can then enter the network name yourself here.</p>
DHCP server	<p>The DHCP service is automatically activated when LAN Mode > Access Point is started and no other DHCP service has been detected in the network.</p> <p>The DHCP service is deactivated when the LAN mode is changed or switched off.</p> <p>IP address allocation: Enter the IP range (start-end) and the validity (period 1-28 days).</p>

■ **Modbus/SunSpec (TCP)**

Activate the protocol, which can be used in the inverter to exchange data with external data loggers linked to the inverter via the LAN interface.

Parameter	Explanation
Activate Modbus	<p>Output of the parameter port (1502) and the parameter ID (71) for Modbus/SunSpec.</p> <p>Activate the protocol on the LAN TCP/IP interface. Used for an external data logger, for example.</p> <p>Little-endian and big-endian can be chosen for the byte order.</p> <p>NOTE! KOSTAL devices and most partner applications use the default setting "little-endian". In some cases it may be necessary to change the byte order to "big-endian".</p>

■ **Solar portal**

Input for the solar portal configuration. If you want to use a solar portal, the log data and events can be sent to the solar portal. **i**

i INFO

The solar portal can only be used for inverters which are linked to the Internet.

Parameter	Explanation
<i>Use portal</i>	Activates the transfer to the solar portal.
<i>Portal</i>	Select the KOSTAL Solar Portal or other portals. When selecting Other portals , a portal code must be entered and confirmed with Apply .
<i>Last transfer</i>	Indicates when the inverter last transferred data to the solar portal (provided the function is active).
<i>Last successful transfer</i>	Indicates when the inverter last successfully transferred data to the solar portal (provided the function is active).
<i>Activate log data export with FTP push</i>	<p>If Use portal has been activated and the KOSTAL Solar Portal has been selected, the log data can be transferred to an external FTP server and saved. A description of the data can be found at Log file: Entries, Page 207.</p> <p>To do this, activate the log data export and configure the FTP push settings.</p> <p>Server: Enter the server address at which the FTP server can be reached.</p> <p>Port: Enter port address (default value is 80)</p> <p>Directory: Specify the directory in which the files are to be stored on the server.</p> <p>Export interval: Select the time interval for the transfer.</p> <p>Use encryption: Use encryption for the data transfer. The server must support encryption for this function to work.</p> <p>Authentication required: If the server is accessed using an ID and password, enter the data for this here.</p> <p>Connection status: Displays the current connection status with the server.</p> <p>Last successful export: Time of the last successful data transfer.</p>



■ Reset system owner settings

Reset system owner settings to factory settings.

Parameter	Explanation
<i>Reset system owner settings</i>	<p>The values for the basic settings, network, Modbus/Sun-Spec and solar portal are reset to the factory settings</p> <p>NOTE! The option "Automatically acquire IP address" is activated for the network by default. This means that the inverter obtains its IP address from a DHCP server. In this case, the same IP address is usually assigned to the inverter via the DHCP server.</p>

Webserver menu – Service menu – General

In the service menu, the installer will find more options for configuring the inverter. Configuring these settings requires precise knowledge of the requirements of the public grid specified by the energy supply company (e.g. reduction of active power, setting of parameters specified by the energy supply company).

INFO

The settings in this menu require special knowledge of the grid configuration.

■ Energy management (only configurable with service code)

Select the connected energy meter on the inverter and the restriction for feeding into the public grid.

INFO

You will find a list of **approved energy meters** and their purpose in the download area for the product on our website at <https://www.kostal-solar-electric.com>

Parameter	Explanation
<i>Energy meter</i>	Selection of connected energy meter.
<i>Sensor position</i>	<p>Select the position of the energy meter fitted in the building services.</p> <p>Grid connection point = position 2</p> <p>Home consumption = position 1</p> <p> Energy meter connection, Page 59</p>



1

2

3

4

5

6

7

8

9

10

11

12

13

14

15

Parameter	Explanation
Limitation of active power to [W] (configurable without service code)	<p>Set the max. feed-in capacity. Requirements relating to this are generally specified by the energy supply company (e.g. a limitation to 70 %). The inverter's max. power serves as the default. Use the calculator to easily calculate the reduction.</p> <p>NOTE! Incorrect settings due to lack of expertise. The system operator is responsible for correctly setting the active power limitation. Your grid operator will provide details of the permissible active power for your system. We recommend that the installer configures all the settings.</p>
Activate the function for receiving broadcast control signals	<p>If there is a ripple control receiver connected to another inverter's digital inputs, the signals for active and reactive power control can be allocated to all inverters in the local area network (LAN) by means of UDP broadcast. A local energy manager can also generate signals for active and reactive power control in the local area network.</p> <p>Activated: The inverter is controlled by means of a ripple control receiver connected to another inverter.</p> <p>Deactivated (default): The signals are not evaluated. The inverter is not controlled by means of a ripple control receiver connected to another inverter.</p>

■ Generator settings

MPP tracking optimisation settings.

Parameter	Explanation
Generator settings	<p>Shadow management: If PV strings are in partial shading, the PV string affected no longer achieves its optimum performance. If shadow management is activated, the inverter adapts the MPP tracker of the selected PV string such that it can operate at maximum possible performance.</p>

■ Battery settings

If a battery is connected to the inverter, its behaviour and usage of the battery can be configured here.

! IMPORTANT INFORMATION

If a battery is set up at a later date via the Webserver or inverter, use the DC switch to switch the inverter off and on again after configuration so that the settings are adopted.

Parameter	Explanation
Battery type	Select the battery connected to the inverter.
Battery control	<p>The battery can be controlled by an external battery management system (e.g. energy supplier). In this case, the charge/discharge capacity of the battery is controlled by the external supplier. The plant owner then receives remuneration for the energy provided, e.g. from the external supplier.</p> <p>☑ External battery control, Page 198</p> <p>Internal (standard):</p> <p>The external control is deactivated.</p> <p>Via digital I/O:</p> <p>External battery management is carried out via the digital inputs on the Smart Communication Board (terminal X401) of the inverter. A presetting can be selected or the digital inputs can be configured according to the provider's specifications.</p> <p>If there are no control signals, the system switches to internal control. It is still possible to read out the device status in parallel using Modbus (TCP)/SunSpec. ☑ External battery control, Page 198</p> <p>Via Modbus (TCP):</p> <p>The external battery management is provided via the Modbus RTU protocol. The control signals are received via the LAN interface. If there are no control signals, the system switches to internal control. It is still possible to read out the device status in parallel using Modbus (TCP)/SunSpec.</p>
Battery discharge as of grid demand of [W]	<p>Input of a minimum grid demand value as of which the battery is used. (Standard 50 W.)</p> <p>Example: If a value of 200 W is set, the battery can only be released to cover the home consumption when the measured grid demand from the public grid exceeds 200 W. The battery is blocked again for home consumption when the grid demand falls 50 W below the set value (in this example 150 W).</p>



Parameter	Explanation
Min. state of charge (SoC) [%]	<p>Set the minimum depth of discharge of the battery.</p> <p>If the smart battery control is also activated, the depth of discharge is automatically adjusted depending on the weather conditions and forecast to make optimum use of the battery.</p>
Smart battery control	<p>Charging and discharging of the battery are controlled completely automatically here. This function should only be activated if the connected PV power is greater than the PV power of the inverter (limitation of inverter set e.g. to 70 %). You should not use this function if an electric vehicle is charged via a wallbox, as no clear consumption forecast can be determined here.</p> <p>If Storage of excess AC energy from local generation (Smart AC Link function) has been activated, the "Smart Battery Control" function is not available.</p> <p>You will find a detailed description in Smart battery control.</p>
Storage of excess AC energy from local generation	<p>If there is an additional AC energy source in the local house grid (e.g. an additional PV system or a combined heat and power unit), the AC energy generated by this source can be stored in a battery connected to the PLENTICORE plus.</p> <p>NOTE! The function can only be activated if the energy meter has been installed at the grid connection point (position 2) and there is a battery connected to the inverter. If storing surplus AC energy from local generation (Smart AC Link function) has been activated, the "Smart Battery Control" function is not available.</p> <p>Activated: The AC energy generated can be stored in the battery.</p> <p>Deactivated: Extra generated AC energy is not stored in the battery.</p>



Parameter	Explanation
<i>Time-controlled battery usage</i>	<p>The charging and discharging operation can be configured very flexibly at different times (tariff periods).</p> <p>There are times when the costs of electricity procurement are relatively high (different tariff models). Therefore, it may make sense to allow the battery to discharge during these periods and to allow charging outside of these periods.</p> <p>The times set here can be overridden by the specifications of an activated external battery management system.</p> <p>Battery charge blocked: battery discharge permitted in the event of demand from house.</p> <p>Battery discharge blocked: battery charge permitted in the event of excess power.</p>
<i>Advanced battery options – Service charging (only possible with service code)</i>	<p>Start service charging to 100%</p> <p>If the SoC of the battery is very low during initial commissioning, this function can be used to charge the battery to 100% once. This is done with solar power or, if there is not enough solar energy available, with energy from the public grid. In this case, "Service charging" is displayed on the inverter.</p>

■ External hardware settings (only configurable with service code)

Setting hardware settings.

Parameter	Explanation
Residual current protection equipment	<p>Compatibility of type A RCD:</p> <p>If this function has been activated, type A RCDs can be used as residual current protection equipment. In such cases, the inverter shuts down when the residual current becomes incompatible with a type A RCD.</p> <p>If the function is deactivated, a type B RCD must be used as residual current protection equipment if an RCD is stipulated.</p>

■ Digital inputs (only configurable with service code)

Parameter	Function
none	There is nothing connected to the digital inputs.
External battery control	If you have activated external control via the digital I/O ports in the "Battery settings" menu, you can define the functions of the inputs here. Assign the desired charge or discharge power to the inputs.
active power control	<p>For the connection of a ripple control receiver with standard switching specifications.</p> <p>Detailed description in chapter Self-consumption. ☑ Active power control, Page 189</p> <p>Activate the distribution of ripple control signals in the house grid.</p> <p>Activated: If a ripple control receiver is connected to the inverter, the control signals of this ripple control receiver are distributed in the local LAN network by means of UDP. Other inverters can therefore also be controlled using the connected ripple control receiver.</p> <p>Deactivated: The control signals are not distributed in the local LAN network by means of UDP.</p>
User-defined active/reactive power control	<p>For the connection of a ripple control receiver. Unlike the standard active power control, here you can specify up to 16 settings. These are usually specified by the energy supply company.</p> <p>Detailed description in chapter Self-consumption. ☑ Active power control, Page 189</p> <p>Activate the distribution of ripple control signals in the house grid.</p> <p>Activated: If a ripple control receiver is connected to the inverter, the control signals of this ripple control receiver are distributed in the local LAN network by means of UDP. Other inverters can therefore also be controlled using the connected ripple control receiver.</p> <p>Deactivated: The control signals are not distributed in the local LAN network by means of UDP.</p>



■ Switched outputs

The inverter is equipped with four switched outputs. The switched outputs can switch external consumers for the purpose of increasing self-consumption or can be configured as indicators for statuses or events. A detailed description can be found in and a description of installation in [☑ Connection of switched outputs, Page 70](#).

Set the function of the switched outputs (terminal X1401 and X1402) on the Smart Communication Board. The 2-pin terminal can be assigned various functions.

Parameter	Explanation
Output	Shows outputs 1-2 on terminal X1401 and outputs 3-4 on terminal X1402.
Operating mode	<p>Select mode:</p> <p>Off: The switched output is deactivated.</p> <p>Load control: Switches on loads when conditions are set (e.g. PV excess).</p> <p>SG ready: Using the SG Ready function is a simple and cost-effective solution to increase PV self-consumption by using a heat pump. The inverter makes it possible to control a heat pump compatible with SG Ready. The SG Ready specification's operating statuses 2 (normal operation) and 3 (start-up recommendation) are supported.</p> <p>Wallbox: For controlling a wallbox so that it starts the charging process for an electric vehicle connected to the wallbox under certain conditions. The wallbox must have a control input. For more information, please refer to your wallbox's manual.</p> <p>Events: The output is switched when a certain event occurs. The event must be selected from the list.</p> <p>External control: The output can be switched by an external energy management system via the Modbus/TCP protocol.</p>



Parameter	Explanation
State	<p>Select the function of the switched output. Function as potential-free normally open contact (NO) or normally closed contact (NC).</p> <p>Normally open contact (NO)</p> <p>Normally, the contact is open. The contact is closed when the set conditions are met.</p> <p>Normally closed (NC).</p> <p>Normally, the contact is closed. The contact is opened when the set conditions are met.</p>
Battery use for switching based on PV power	The settings made here apply to all outputs where switching is configured based on PV power.

■ Evaluation of overvoltage protection

Activate the evaluation of an external message signal. The inverter can evaluate the message output of the overvoltage modules (SPD) and output a message if an event occurs. Information on connection and wiring can be found under  **Connecting the signal contact for the external overvoltage protection (SPD – Surge Protective Device), Page 68.**



INFO

The setting can only be carried out by an installer with a service code.

Evaluation of the external message signal	Activate the function
The monitor signal is interconnected as	<p>Select overvoltage module switching status</p> <p>Normally open contact (NO)</p> <p>Normally, the contact is open. If an error occurs, the contact closes and the inverter issues a message.</p> <p>Normally closed (NC).</p> <p>Normally, the contact is closed. If an error occurs, the contact opens and the inverter issues a message.</p>

■ Extra options

This function can be used to release additional options for the inverter. This may be e.g. releasing the DC3 input to connect battery storage.



Parameter	Explanation
Release new option	Enter an activation code, e.g. to connect a battery. This first has to be purchased from the KOSTAL Solar online shop. NOTE! The activation code can be purchased from the KOSTAL Solar online shop. The following link will take you to the shop: shop.kostal-solar-electric.com
Released options	Overview of options currently released in the inverter

See also

External battery control [▶ 198]

Webserver menu – Service menu – Grid parameterization

The following menu items can be used to set the parameters in the inverter, which are specified by the grid operator.

**IMPORTANT INFORMATION**

The settings may only be adjusted by trained and qualified electricians.

The electrician is responsible for ensuring that the applicable standards and regulations are observed and implemented. Work that could affect the electrical power system of the respective energy supply company at the site of the solar energy feed-in may only be carried out by qualified electricians expressly authorised (licensed) by the energy supply company.

This includes changes to the factory preset parameters of the inverter.

Parameters may only be changed on the inverter by qualified electricians who are familiar with the system and at the request of the grid operator.

Inappropriate settings can be hazardous and lead to injury or even death of the user or third parties. Material damage to the device and other equipment can also occur.

- **Display parameterisation report**

The parameterisation report provides an overview of the parameters set in the inverter.

- **Reactive power settings (only configurable with service code)**

The following can be selected:



Parameter	Explanation
No reactive power mode active	No reactive power is set.
Reactive power Q	The grid operator (energy supply company) specifies a fixed reactive power in Var.
Displacement factor $\cos \phi$	The grid operator specifies a fixed displacement factor $\cos \phi$.
Reactive power/voltage characteristic curve Q(U)	The grid operator specifies a characteristic curve Q(U).
Displacement factor/power curve $\cos \phi$	The grid operator specifies a characteristic curve for $\cos \phi$ (P).

■ Configuration of the start-up ramp (only configurable with service code)

Parameter	Explanation
Ramp time [s]	States the inverter's wait time in seconds after a restart or grid error before starting up. The ramp time is also used for P(f) and P(U).

■ Configuration of LVRT/HVRT (only configurable with service code)

Parameter	Explanation
LVRT	Configuration of Low-Voltage-Ride-Through LVRT is the electrical ability to provide dynamic grid support through electrical generation units.
HVRT	Configuration of High-Voltage-Ride-Through HVRT is the electrical ability to provide dynamic grid support through electrical generation units.

■ Configuration of power reduction if overfrequency occurs P(f) (only configurable with service code)

Parameter	Explanation
Reduction curve	The characteristic curve is defined by a change in frequency which is expressed as a percentage of the rated frequency and causes a 100% change in rated output.

Parameter	Explanation
Conditions for returning to normal mode	Input of frequency range and waiting time in seconds

- Configuration of power reduction if overvoltage occurs P(U) (only configurable with service code)

Parameter	Explanation
Reduction curve	The characteristic curve is defined by a voltage start and end point. The power is reduced by 0% at the start point and by 100% at the end point.
Settling time	Selection of the settling time
Conditions for returning to normal mode	The reduction in power ends once the voltage has fallen below the specified value and the stated waiting time has passed.

- Settling time (only configurable with service code)

Set the settling time when externally controlling the reactive power or active power using ripple control receiver or Modbus.

Parameter	Explanation
Settling time [s]	When externally controlling the reactive power (Q, cos φ), the settling time can be set in seconds. Select the specifications of the grid operator (energy supply company) here.
Mode	With external control of active power, the following parameters can be set. Standard: no further details needed (default) PT1: Selection of the settling time in seconds. Power gradient: Input of maximum power limit gradient. Enter the specifications of the grid operator (energy supply company) here.

- Grid and system protection (only configurable with service code)

The settings for the grid and system protection may only be changed in exceptional cases for good reason and in consultation with the grid operator (energy supply company).

Parameter	Explanation
Shutdown limits for voltage	The settings for the grid and system protection may only be changed in exceptional cases for good reason and in consultation with the grid operator (energy supply company). Enter the specified values in the corresponding fields.
Shutdown limits for frequency	
Use switchable shutdown limits	
Start-up conditions	

■ **Grid and system protection self-test**

Performs a self-test with the set values and outputs the result.

WebsERVER menu – Update

A software update can be imported into the inverter using this menu.

Various update methods are available to the user for this purpose.

Parameter	Explanation
System update	<p>Manual updates:</p> <p>The inverter must be updated manually. To do this, click on Look for updates or drag an update file into the lower field.</p> <p>To start the inverter update, select the Execute button. <input checked="" type="checkbox"/> Updating software, Page 219</p> <p>Find out about new updates:</p> <p>The inverter checks at regular intervals whether an update is available. If a new update is available, this is indicated by the software update symbol in the header. To start the inverter update, select the Execute button.</p> <p>Automatic updates (recommended):</p> <p>If this is selected, a new update is installed on the inverter as soon as it is available.</p>
Look for updates	<p>This function can be used to search for current updates on the manufacturer's server.</p> <p>To start the inverter update, select the Execute button. <input checked="" type="checkbox"/> Updating software, Page 219</p>

Webserver menu – Info

Displays all events and version numbers of the inverter.

■ Device information - Devices

Shows information about the versions installed on the inverter. Information about the device can also be viewed without logging in to the Webserver.

Parameter	Explanation
Name of device	Name of inverter. Can be changed by going to Settings > Basic settings .
Serial number	Inverter serial number
Article number	Article number of the inverter
SW	Software version (SW)
MC version	Main controller software version
IOC version	I/O controller software version
HW version	Hardware version
Country setting	Shows the inverter's country setting
Battery input	Status of DC input 3 battery

■ Device information – Network

Provides information about the assigned network settings.

LAN parameter	Explanation
Network information	<p>Static</p> <p>The network settings have been assigned manually.</p> <p>DHCP</p> <p>The network settings have been obtained automatically.</p>
IPv4 address	Shows the specified IP address of the inverter
Subnet mask	Shows the specified subnet address
Gateway	Shows the router/gateway address
DNS server	Shows the address of the 1st and 2nd DNS server (Dynamic Name Server)
MAC address	Shows the physical address of the network interface



WLAN parameter	Explanation
Network configuration	<p>Wifi off</p> <p>The inverter's Wifi interface is deactivated.</p> <p>Access point</p> <p>The inverter offers a Wifi access point.</p> <p>Client</p> <p>The inverter is a Wifi client and can connect to a Wifi gateway in the local home network.</p>
Network information	<p>Static</p> <p>The network settings have been assigned manually.</p> <p>DHCP</p> <p>The network settings have been obtained automatically.</p>
IPv4 address	Shows the specified IP address of the inverter
Subnet mask	Shows the specified subnet address
Gateway	Shows the router/gateway address
DNS server	Shows the address of the 1st and 2nd DNS server (Dynamic Name Server)
MAC address	Shows the physical address of the network interface

Solar portal parameters	Explanation
Last connection to the solar portal	Last transfer in minutes or time

■ Device information – Events

Up to 10 events can be displayed. Additional information about the event can be displayed via Info (i) next to the event.



7. Switched outputs

7.1	Switched outputs at a glance.....	170
7.2	Connection for self-consumption control.....	173
7.3	Set up self-consumption control for load control	176
7.4	Set up self-consumption control for heat pumps (SG Ready)	179
7.5	Set up self-consumption control for wallbox.....	181
7.6	Set up switched output for reporting events.....	183
7.7	Switched output via external control.....	185



1

2

3

4

5

6

7

8

9

10

11

12

13

14

15

7.1 Switched outputs at a glance

Four digital switched outputs with a load capacity of 24 V/100 mA each are available at the inverter's X1401/X1402 terminals. These can be used to control existing loads or actuators.

In addition, events that occur can be signalled. If there is an event message, the inverter can trigger an actuator connected to the switched output (warning light, message signal, smart home system), providing information about the event that occurred.

For this purpose, the switched outputs can be configured for the different operating modes via the Webserver. The corresponding switched output is activated or deactivated as soon as the configured conditions occur.

In the **Load control**, **SG ready** and **Wallbox** modes, you can select the basis for the switched output to be activated. You can decide whether the output switches based on the excess power fed into the utility grid or when a certain PV power is exceeded.

The **Battery use for switching based on PV power** area can be used to configure how a connected battery is used. The settings made here apply to all switched outputs that switch based on **PV power**. If the switch-on conditions are met, the battery may be discharged to the set SoC by the connected consumer.

For information on connecting self-consumption control, see [☑ Connection for self-consumption control, Page 173](#).

Configure self-consumption control

1. Call up the Webserver.
2. Go to **Service menu > Switched outputs**.
3. Under Configuration for **Output x**, select the **Operating mode** and the **Status** of the switch.
4. Go to **Output x:...** and configure the conditions, such as **Switch output based on > PV power** or **Grid excess**.
5. If **Switch output based on PV power** has been selected, the **Battery use for switching based on PV power** can be configured if desired. This setting applies to all switched outputs that are to be switched based on PV power.

The switched output is only activated when SoC [%] >=: This specifies from which SoC the affected switched output and, therefore, the battery can be used. If the switched outputs are to be used independently of the battery's SoC, set the value to 5%. This means that the battery is always used jointly. If you want the battery to have a reserve, set the value higher or to 100%. This means that charging the battery has higher priority than using the switched output.

Allow battery discharge only if SoC [%] >= If the output has been activated, the battery can be used. It is discharged down to the SoC entered here. If the battery should not be used, set the value to 100%.



1

2

3

4

5

6

7

8

9

10

11

12

13

14

15

6. Save the settings.
- ✓ Configuration is complete.

Possible operating modes

- **Load control:** The switched output is activated as soon as the configured excess occurs. A consumer can then be switched on via a relay [Set up self-consumption control for load control, Page 176](#)
- **SG ready:** Generated energy can be made available to a heat pump [Set up self-consumption control for heat pumps \(SG Ready\), Page 179](#)
- **Wallbox:** Use energy to charge an electric vehicle [Set up self-consumption control for wallbox, Page 181](#)
- **Events:** Activate the switched output for certain events, e.g. to activate a signal horn [Set up switched output for reporting events, Page 183](#)
- **External control:** The output is switched externally (via Modbus/TCP) and can thus switch a consumer, e.g. a battery [Switched output via external control, Page 185](#)

Possible statuses

- **Normally open contact (NO):** Normally the contact is open (NO = normally open). The contact is closed when the set conditions are met.
- **Normally closed contact (NC):** Normally the contact is closed (NC = normally closed). The contact is opened when the set conditions are met.

See also

- [Set up self-consumption control for load control \[▶ 176\]](#)
- [Set up self-consumption control for heat pumps \(SG Ready\) \[▶ 179\]](#)

Switched outputs



1

2

3

4

5

6

7

8

9

10



11

12

13

14

15

-  Set up self-consumption control for wallbox [[▶ 181](#)]
-  Set up switched output for reporting events [[▶ 183](#)]
-  Switched output via external control [[▶ 185](#)]



1

2

3

4

5

6

7

8

9

10

11

12

13

14

15

7.2 Connection for self-consumption control

The inverter offers the option of connecting consumers to the inverter via an external load relay or directly to the switched outputs (e.g. OUT1).

If the PV or grid excess power is sufficiently high, the switched output is then switched on to access the PV energy that is currently being generated.

Connection options:

- Use of a load relay to decouple and control 230 V loads.
- Direct connection to the digital input's switched output, e.g. for a heat pump or wallbox or to the input module of a smart home system.

Check which connection method is required for the device. For more information, please refer to the manual of the device to be controlled.

Connection example with load relay:

- **Load control operating mode:** Here, an external load (e.g. washing machine or air conditioning system) is triggered.
- **Events operating mode:** As soon as an event is present, an external load (e.g. lamp or signal horn) is triggered.

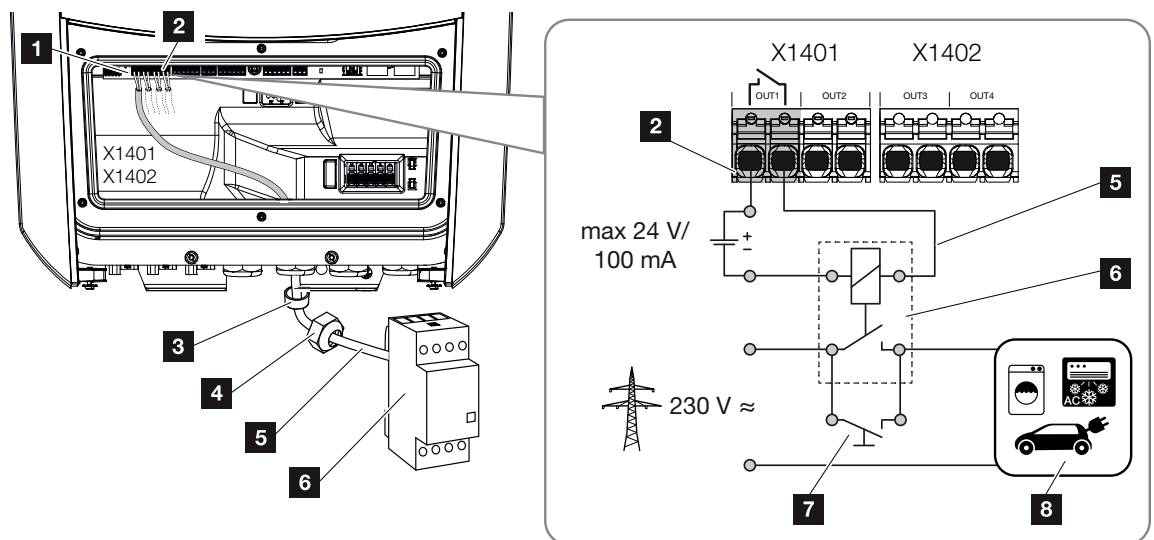

- 1 Smart Communication Board (SCB)
- 2 Terminal for self-consumption control
- 3 Sealing ring
- 4 Union nut
- 5 Control line
- 6 Load relay/connection via potential-free contact



1

2

3

4

5

6

7

8

9

10

11

12

13

14

15

- 7 Jumper switch
- 8 Consumer device

Connection example, direct connection to the switched output via potential-free contact:

- **SG Ready operating mode:** Here, the switching signal (e.g. contact closes) for using the PV energy is transferred directly to the heat pump's digital input.
- **Wallbox operating mode:** The charging process is started as soon as the contact is closed. The wallbox offers a digital/signal input for this purpose.
- **Events/external control operating mode:** The external device is controlled via a digital/signal input. This can be, for example, a KNX control unit or another smart home system.

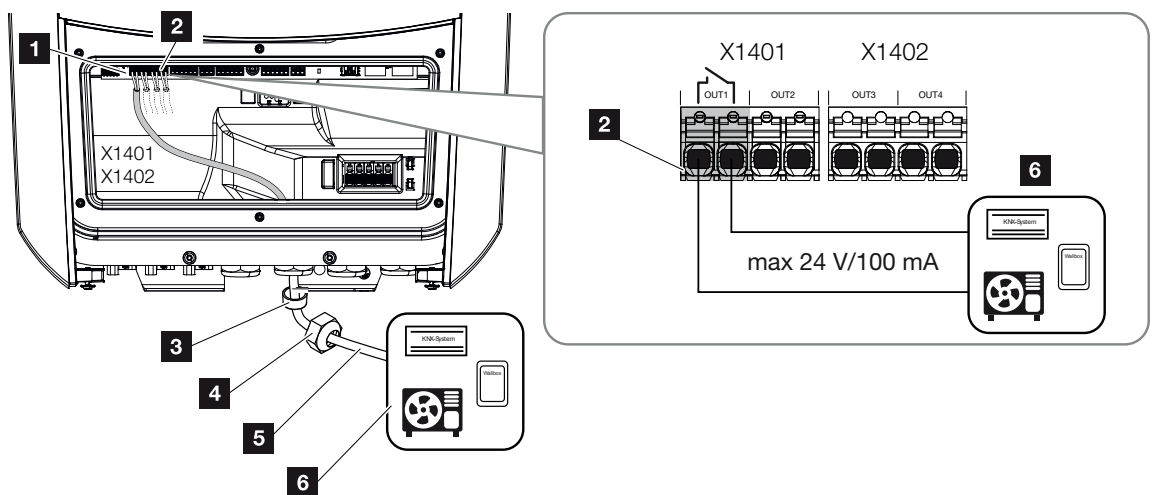

- 1 Smart Communication Board (SCB)
- 2 Terminal for self-consumption control
- 3 Sealing ring
- 4 Union nut
- 5 Control line
- 6 Consumer device

For the electrical connection of the self-consumption control, proceed as follows:



1

2

3

4

5

6

7

8

9

10

11

12

13

14

15

**INFO**

If loads need to be switched and require a higher load at the switched output than 24 V/ 100 mA, an external load relay must be installed between the inverter and the consumer. No consumers may be connected directly to the inverter.

In the case of loads or consumers that are controlled via a potential-free switching contact (e.g. SG-ready heat pump control or smart home systems), these consumers can be connected directly to the switched output.

Switched output load, potential-free:

Max. load: 100 mA

Max. voltage: 24 V (DC)

1. De-energise the house grid.

**DANGER****Risk of death due to electrical shock and discharge!**

De-energise device and secure against being switched on again. **De-energising the inverter, Page 99**

2. Connect the load relay professionally or connect the consumer to the self-consumption control terminal on the Smart Communication Board.

**INFO**

The signal cable is subject to the following requirements:

Conductor cross-section from 0.2 to 1.5 mm²

Length of stripped insulation 8 mm

3. Properly install and connect the other components of self-consumption control.
 - ✓ The electrical connection for self-consumption control has been made. Switch on the inverter.



7.3 Set up self-consumption control for load control

Switches on loads when conditions are set (e.g. PV excess).

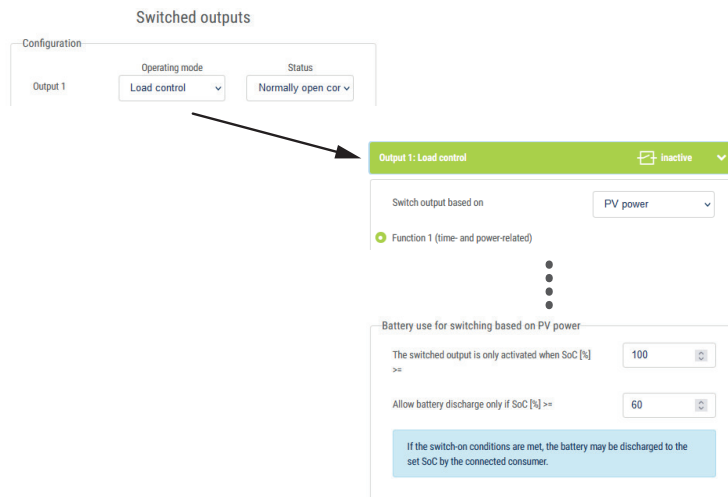

1. Select an output, e.g. 1, and the **load control operating mode**.
2. Under **Status**, select whether the switch is closed or opened when the set conditions are met.
3. Select the set output, e.g. 1, below and set the conditions.
4. Select whether the switched output is to be switched at a specific **PV power** or **grid excess**.
5. Choose function 1 or function 2.



INFO

You can find more detailed explanations regarding the selection of function 1 or 2 in the course of the chapter.

6. Enter values for the function.
7. Optionally activate the value for **Leave switched output activated in event of power loss or fault** using the checkbox and enter the time period.
8. Optionally select **Battery use for switching based on PV power**.
9. Click on "Save".
- ✓ The "Self-consumption control" function is active.



Function 1

Control of self-consumption by time

When a certain output **P1** has been generated for a certain time **T1**.

The inverter remains in "Self-consumption" mode for the run time **T2**. Following the run time **T2**, the inverter ends self-consumption.

This is the end of the interval. This interval can be repeated several times with the "Activation" option.

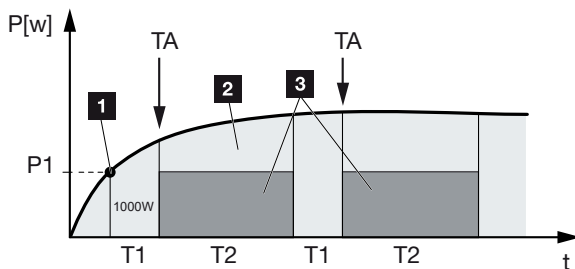

- 1 Power limit
- 2 Feed-in to the public grid
- 3 Self-consumption via self-consumption contact

P1: Power limit

This is the minimum power (in watts) that must be produced (e.g. 1000 W) before the consumer is switched on. You can enter any value from 1 watt to 999,000 watts.

T1: Period of stable exceeding of the power limit (P1)

The inverter must exceed the set **power limit** for this period of time (in minutes) before the consumer is switched on. You can enter any value between 1 and 720 minutes (= 12 hours).

T2: Run time

The connected consumer is switched on for this period (in minutes) when both of the above conditions have been met. You can enter any value between 1 and 1440 minutes (= 24 hours). The run time ends when the inverter shuts off. The run time is ended and not continued again if the inverter has not produced any current for three hours.

TA: Frequency of activation [number/day]

Number/day indicates how often self-consumption is activated per day.

Function 2

Control of self-consumption by output

When a certain output **P1** has been generated (e.g. 1000 W), the switching contact is closed.

When the output **P2** is not reached (e.g. 700 W), the inverter ends self-consumption and resumes feeding current into the grid.



1

2

3

4

5

6

7

8

9

10

11

12

13

14

15

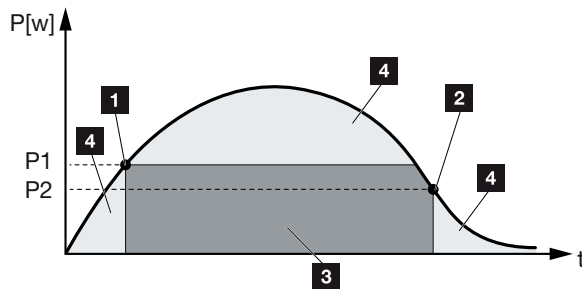

- 1 Activation limit
- 2 Deactivation limit
- 3 Self-consumption via self-consumption contact
- 4 Feed-in to the public grid

P1: Activation limit

This is the minimum power (in watts) that must be produced before the consumer is activated. You can enter any value from 1 watt to 999,000 watts.

P2: Deactivation limit

The consumer is switched off when the power generated falls below this value.

Other options

Leave switched output activated in event of power loss or fault

With this function, self-consumption is only discontinued after the set delay time **T1**. In the event of power loss, fault (**Tx**) and failure to achieve the shutdown limit, the consumer remains switched on for the set time (**T1**).

If the fault period or the period of power loss is shorter than the set delay time, self-consumption remains activated.

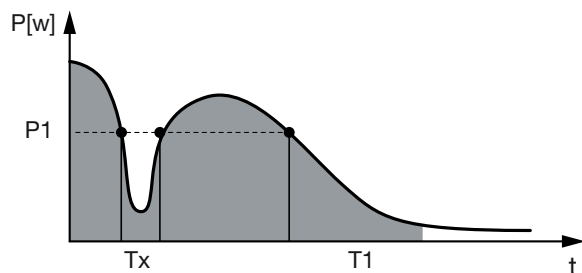

P1: Power limit

T1: Delay time in the event of power loss/fault

Tx: Fault, power loss or failure of the inverter

Dashed area: Self-consumption active

7.4 Set up self-consumption control for heat pumps (SG Ready)

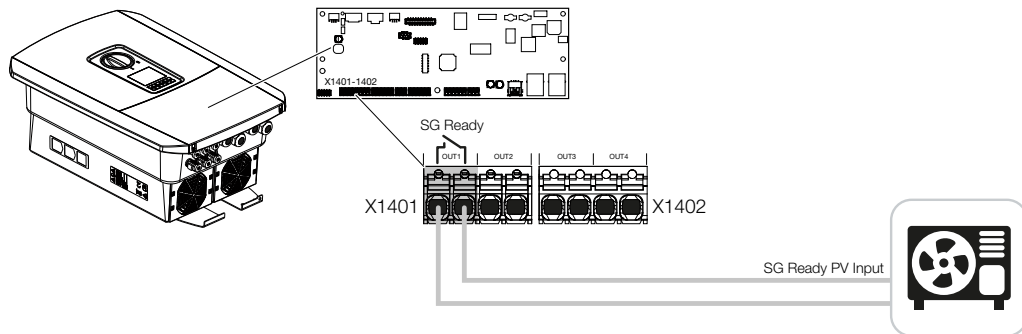

Using the **SG Ready** function is a simple and cost-effective solution to increase PV self-consumption by using a heat pump. The inverter allows a heat pump with **SG Ready** compatibility to be controlled.

The **SG Ready** specification's operating statuses 2 (normal operation) and 3 (start-up recommendation) are supported.

The heat pump/heating element is switched on when the set conditions are met. The **SG Ready** mode can be configured for this purpose via the inverter's Webserver menu.

In this mode, the switching signal is used to give the heat pump a start-up recommendation (in accordance with **operational status 3 of the SG Ready specification**). In this operational status, the heat pump runs within the controller in boosted operation for heating and domestic hot water preparation.

The configured switch-on limit should therefore at least correspond to the power consumption required for boosted operation.

For further information on connection and power consumption, please refer to the heat pump's operating manual.

Example setting: Webserver

Switched output no. 1 (OUT1) is used. This should switch based on grid excess power. According to the manufacturer, the heat pump's boosted operation (operating mode 3) requires 1700 W.

The **activation limit** is set to the 1700 W required for boosted operation.

50 W is entered under **deactivation limit**.

As soon as the 1700 W power is exceeded for the set period, the output becomes active for the selected duration, which is at least 10 minutes. The grid excess drops below the deactivation limit to approx. 0 W as soon as the heat pump switches to enhanced operation.

After the **minimum duty cycle** has elapsed, the switched output becomes inactive again.



1

2

3

4

5

6

7

8

9

10

11

12

13

14

15

You can set the maximum number of times the behaviour described above may be repeated per day in the **Frequency of activation** field.

Switched outputs

Configuration

	Operating mode	Status
Output 1	SG Ready	Normally open con
Output 2	off	Normally open con
Output 3	off	NC contact (NC)
Output 4	off	NC contact (NC)

Output 1: Inactive

Switch output based on: Grid excess

Activation limit [W]: 1700

Deactivation limit [W]: 50

Limit must be exceeded for [min]: 10

Minimum duty cycle [min]: 10

Frequency of activation [number/day]: 6

Other options

Leave switched output activated in event of power loss or fault

Permitted period of time for power loss or fault [min]: 1

**INFO**

If the output is to be switched based on **PV power**, we recommend adding the base load of the house consumption (approx. 150 to 500 W) to the activation and deactivation limit.

SG Ready settings

Parameter	Explanation
Switch output based on	Grid excess or PV power.
Activation limit [W]	The switched output is activated as of this value.
Deactivation limit [W]	Below this value, the switched output is deactivated.
Limit must be exceeded for [min]	The activation/deactivation limit must be exceeded by the number of minutes specified before the switched output is activated/deactivated. This prevents devices from being repeatedly switched on/off if, for example, no PV energy is available for a short time. 10 minutes is reasonable here.
Minimum duty cycle [min]	The switched output remains active at least until the set time has been reached. This prevents devices from being repeatedly switched on/off. The SG Ready specification states that the signal must be active for at least 10 minutes. Therefore, it is not possible to set a lower value.
Frequency of activation [number/day]	Indicates the maximum number of activations per day. For heat pumps, it is recommended to enter a maximum of 10 activations per day.



1

2

3

4

5

6

7

8

9

10

11

12

13

14

15

7.5 Set up self-consumption control for wallbox

The inverter allows a compatible wallbox connected to the switched output to be controlled. This is a simple and cost-effective solution to increase PV self-consumption by using a wallbox.

Using the switching signal, the inverter can give the wallbox approval for charging or change the charging current specification. For further information on activation, please refer to the wallbox manual.

The period during which the output can be activated can be set based on a 24h period for each day of the week. Charging the electric vehicle is permitted during the set time periods.

With the help of an AND or OR link, the approval to charge the electric vehicle can additionally be combined with the PV power or grid excess power.

This makes it possible to charge an electric vehicle directly from PV. Charging the connected battery is given secondary priority. This means that the electric vehicle is charged first via the wallbox and only then is the storage system charged.

It is not possible to use the storage system connected to the inverter when the output is active.

The screenshot shows the configuration interface for 'Output 1: Wallbox'. At the top, it indicates the output is 'inactive'. Below this, a table titled 'Fahrzeugladung während folgender Zeiträume erlaubt:' (Vehicle charging during the following periods allowed) shows a weekly schedule. The x-axis represents hours from 0 to 24. The y-axis lists the days of the week. Blue bars indicate when charging is allowed: Monday (14:00-22:00), Tuesday (10:00-18:00), Wednesday (no charging), Thursday (no charging), Friday (no charging), Saturday (10:00-20:00), and Sunday (no charging). Below the table, there are checkboxes for 'Output inactive' and 'Output active (charging allowed)'. A dropdown menu is set to 'or'. The 'Switch output based on' dropdown is set to 'Grid excess'. The 'Wallbox enable if power [W] >=' is set to 1500. The 'Minimum run time [min]' is set to 120.

Parameter	Explanation
Allow vehicle charging during the following periods	<p>The table allows configuration of the time periods in which the electric vehicle may generally be charged. The time periods can be set via mouse click/tap.</p> <p>The first click sets the start time and the second the end time. Then select the function (active/inactive).</p>



1

2

3

4

5

6

7

8

9

10

11

12

13

14

15

Parameter	Explanation
Link	Select No/AND/OR linkage. If No linkage is selected, the lower switching settings based on power and the wallbox enable are greyed out.
Switch output based on	Grid excess: There is excess available at the grid connection point. PV power: Excess PV is available.
Wallbox enable if power [W] \geq	Activated when the power is greater than the set value.
Minimum run time [min]	The switched output remains active at most until the set time has been reached.



1

2

3

4

5

6

7

8

9

10

11

12

13

14

15

7.6 Set up switched output for reporting events

The output is switched when one or more events are active in the inverter. The user is informed about the event at the same time. The output can, for example, switch to a smart home system that processes the signal.

Example: The output can be used to switch off a consumer if a certain event occurs or to activate a signal lamp to indicate a fault.

1. Select event from the list.
 2. Optionally select **Battery use for switching based on PV power**.
 3. Click on **Save**.
- ✓ The "Self-consumption control" function is active.

A switched output can be configured for the following events.

Event	Setting condition	Resetting condition
Grid fault/residual current/insulation fault	A grid fault/residual current/insulation fault is active.	A grid fault/residual current/insulation fault is no longer active.
External generator fault	An external generator fault is active.	An external generator fault is no longer active.
Power reduction	Power reduction is active.	Power reduction is no longer active.
System fault	A system fault is active.	A system fault is no longer active.
Excess temperature	Excess temperature is active.	Excess temperature is no longer active.
Fan fault	A fan fault is active.	A fan fault is no longer active.
Energy meter fault	An energy meter fault is active.	An energy meter fault is no longer active.
Battery malfunction	A battery malfunction is active.	A battery malfunction is no longer active.
Battery communication fault	The event (ID 5013) is active.	The event (ID 5013) is no longer active.
Ext. overvoltage protection defective	If there is an active signal at the SPD monitor input.	There is no longer an active signal at the SPD monitor input.
External insulation fault	An insulation fault is active.	An insulation fault is no longer active.

Switched outputs



1

2

3

4

5

6

7

8

9

10

11

12

13

14

15

Event	Setting condition	Resetting condition
External residual current	Residual current is active.	Residual current is no longer active.
Internal parameterisation fault	A parameterisation fault is active.	A parameterisation fault is no longer active.
Internal communication fault	A communication fault is active.	A communication fault is no longer active.



1

2

3

4

5

6

7

8

9

10

11

12

13

14

15

7.7 Switched output via external control

The switched output can be switched by an external energy management system via the Modbus/TCP protocol.

Switched outputs

Configuration		
	Operating mode	Status
Output 1	External control ▾	Normally open cor ▾
Output 2	▾	Normally open cor ▾
Output 3	Events ▾	NC contact (NC) ▾
Output 4	External control ▾	NC contact (NC) ▾

Output 1: External control inactive ▾

The output is switched externally (Modbus TCP)

INFO

Activate Modbus/TCP in the inverter.

The Modbus/TCP protocol must be activated in the inverter under **Settings > Modbus / SunSpec (TCP)**.



1

2

3

4

5

6

7

8

9

10

11

12

13

14

15

8. Overvoltage protection

8.1 Configure evaluation of external overvoltage protection in the Webserver 187

8.1 Configure evaluation of external overvoltage protection in the Webserver

If overvoltage protection/a surge protective device (SPD) has been installed in your system, you can connect the potential-free signalling contact of the overvoltage protection module to terminal X402 of the inverter and monitor the correct function of the module. If an error occurs, the inverter outputs an event code and reports this to the KOSTAL Solar Portal.

In addition, you can set up a switched output for event messages **Set up switched output for reporting events, Page 183.**

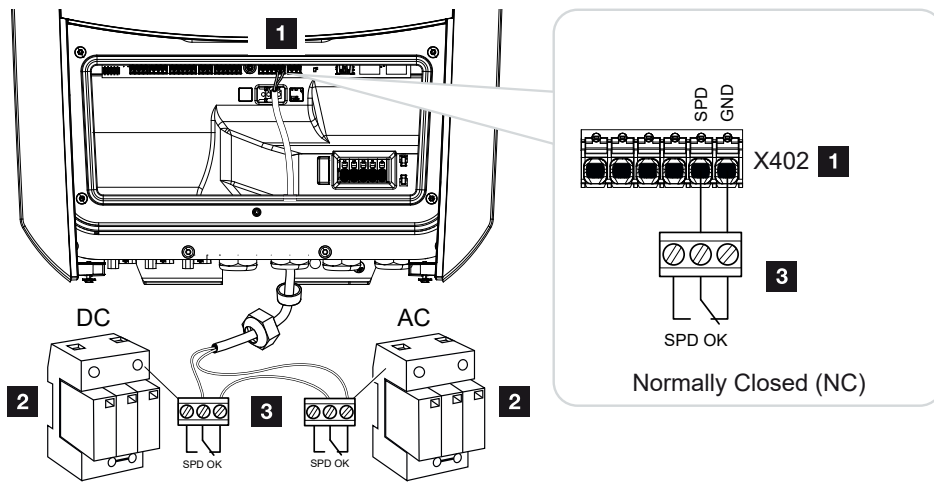

Fig. 5: Overvoltage protection (SPD) as NC contact

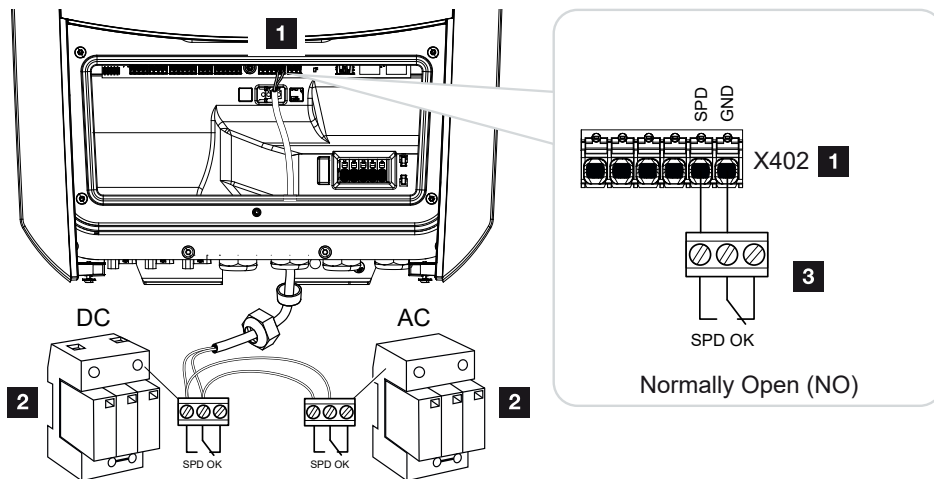

Fig. 6: Overvoltage protection (SPD) as NO contact

Activate evaluation of overvoltage protection

1. Connect inverter and computer. **Connecting the inverter/computer, Page 127**



1

2

3

4

5

6

7

8

9

10

11

12

13

14

15

2. Launch an Internet browser.
3. Call up the Webserver. To do this, enter the IP address of the inverter in the address bar of the Internet browser and confirm with **ENTER**.



INFO

The IP address can be read on the inverter's display.

- The Webserver page is opened.
- 4. Log in to the Webserver as an **installer**.
- 5. Select the menu item **Service menu > General > Overvoltage protection** .
- The **Overvoltage protection** page opens.
- 6. Activate **Evaluation of the external message signal (terminal X402)**.
- 7. Under **Signal is wired as**, select the function **normally open (NO)** or **normally closed (NC)**.
- 8. Click on the **Save** button.
- ✓ The function is active.



9. Active power control

9.1	Why active power control?	190
9.2	Limitation of the PV feed-in capacity	191
9.3	Active power control with a ripple control receiver	192
9.4	Active power control using smart measuring systems	195



9.1 Why active power control?

Some countries or local energy supply companies may stipulate that the full power of the PV system must not be fed into the public grid (e.g. by limiting it to just 70%).

In this case, some energy supply companies therefore offer the owners of PV systems the option of having the energy supply company regulate their system using variable active power control, and thus increasing the generation capacity to up to 100% again.

Ask your energy supply company what application rule applies to you.

The planner of a PV system can usually choose between two types of active power control:

INFO

When selecting active power control, check to determine which of the two options offers the better energy yield for you.

- Limitation of the feed-in capacity to a defined percentage of the PV power at the grid connection point
 - ☑ **Limitation of the PV feed-in capacity, Page 191**
- Active power control with a ripple control receiver
 - ☑ **Active power control with a ripple control receiver, Page 192**



1

2

3

4

5

6

7

8

9

10

11

12

13

14

15

9.2 Limitation of the PV feed-in capacity

If the energy supply company stipulates a limitation on PV power for your PV system and you are not able or do not want to implement active power control with a ripple control receiver, then the feed-in capacity should be reduced to the value stipulated by the energy supply company (e.g. 70%).



IMPORTANT INFORMATION

Incorrect settings due to lack of expertise.

The system operator is responsible for correctly setting the active power limitation. Your grid operator will provide details of the permissible active power for your system.

We recommend that the installer configures all the settings.

Ask your energy supply company what power limitation applies to you.

The power limitation can be set by going to the inverter menu **Settings/information > Service menu > Energy management > Input of max. feed-in capacity** or using the Web-server by going to **Service menu > Energy management > Limit to [W]**.



INFO

In some applications, a compatible energy meter may be seen as an attractively priced alternative to the ripple control receiver. Here the feed-in may well be limited by the energy supply company, but the inverter controls the flow of energy (self-consumption in house grid and feed-in to the public grid) in such a way that the self-produced energy is not lost or loss is kept to an absolute minimum.

Dynamic active power control can be activated in the inverter to this end. **Active power control, Page 189**



1

2

3

4

5

6

7

8

9

10

11

12

13

14

15

9.3 Active power control with a ripple control receiver

The active power of the inverter can be controlled directly by the energy supply company via a ripple control receiver.

i INFO

The ripple control receiver can be connected directly to the inverter's Smart Communication Board or is connected to another inverter.

With this technology, the generated power can be regulated at four levels:

i INFO

The four standard specifications for power limitation can be changed using the Web-server. However, the provisions of the energy supply company must be observed.

- 100%
- 60%
- 30%
- 0%

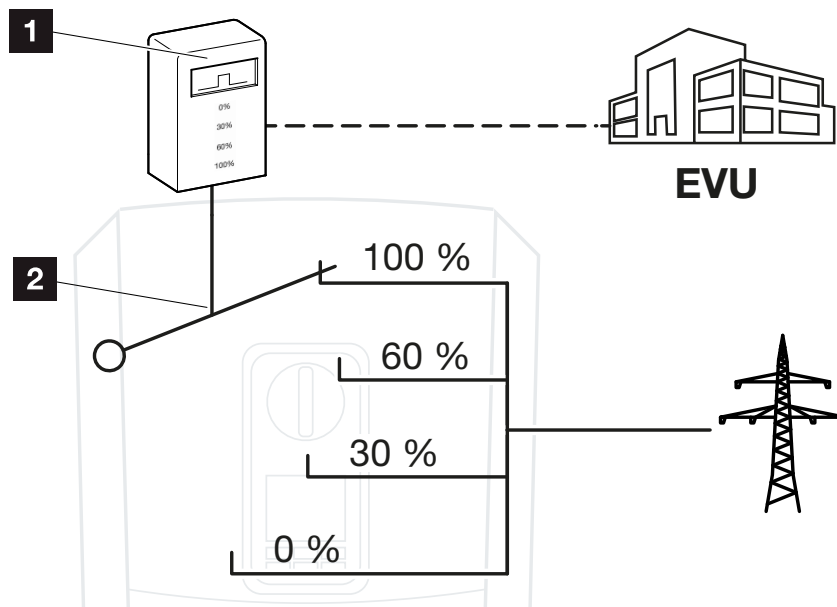

- 1 Ripple control receiver
- 2 Control electronics of the inverter



1

2

3

4

5

6

7

8

9

10

11

12

13

14

15

- If the active power control is to be controlled by the ripple control receiver on the inverter, please perform the following steps: **☑ Activating active power control, Page 193**
- If the active power control is to be controlled by another ripple control receiver, please perform the following steps: **☑ Activate receipt of control signals for active power control, Page 193**

Activating active power control

1. Connect inverter and computer. **☑ Connecting the inverter/computer, Page 127**
2. Launch an Internet browser.
3. In the address bar of the browser, enter the IP address of the inverter to which the ripple control receiver is connected and confirm with **Return**.



INFO

The IP address can be read on the inverter's display.

- The Webserver page is opened.
- 4. Log into the Webserver as an installer
- 5. Go to **Service menu > Digital inputs**.
- The **Digital inputs** page opens.
- 6. Select the "Active power control" function.
- 7. If the control signals of this ripple control receiver are to be distributed in the local LAN network (home network) by means of UDP, select **Activate the distribution of ripple control signals**. Other inverters can therefore also be controlled using the connected ripple control receiver in the local LAN network.
- 8. Click on the **Save** button.
- ✓ Active power control is enabled.

Activate receipt of control signals for active power control

If a ripple control receiver is already connected to another KOSTAL solar inverter in your home network, you can use the control signals of this ripple control receiver.



1

2

3

4

5

6

7

8

9

10

11

12

13

14

15

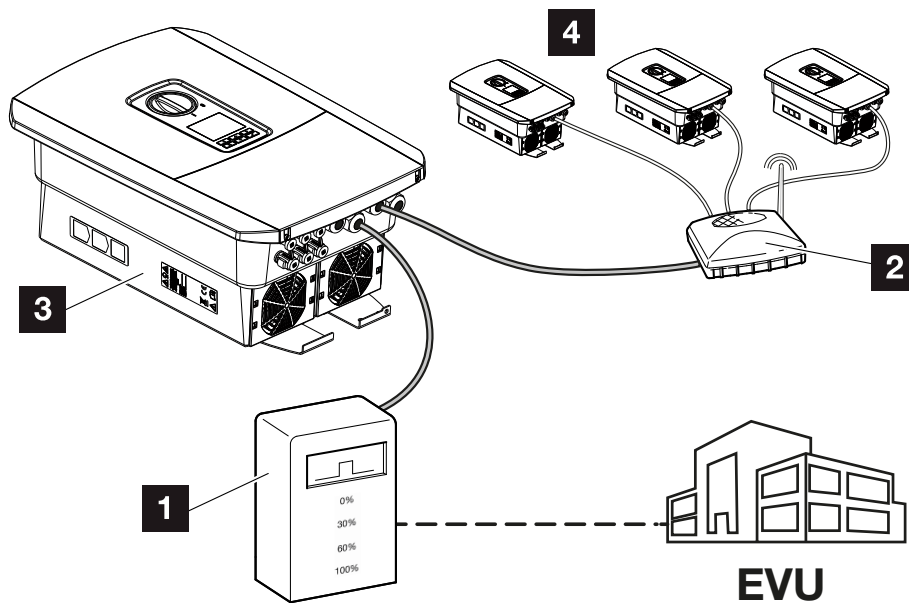

- 1 Ripple control receiver
- 2 Router/switch
- 3 Inverter with ripple control receiver, which distributes the control signals in the home network
- 4 Inverter without ripple control receiver, which uses the control signals of another ripple control receiver

Do this by performing the following steps:

1. Log into the Webserver as an installer
2. Go to **Service menu** > **Energy management**.
→ The **Energy management** page opens.
3. Select the **Receipt of broadcast control signals activated** function.
4. Click on the **Save** button.
✓ The receipt of broadcast control signals is active.



9.4 Active power control using smart measuring systems

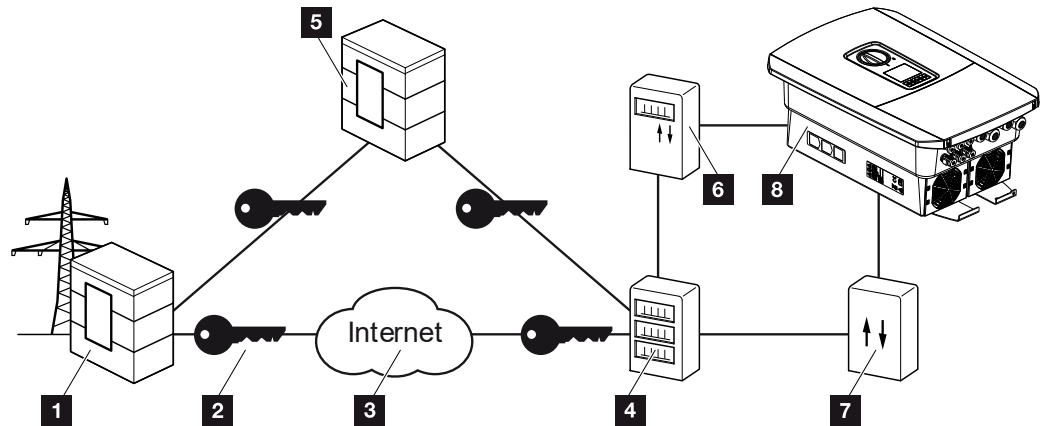

- 1 Energy supply company
- 2 Encryption
- 3 World Wide Web (Internet)
- 4 Smart meter gateway
- 5 Gateway
- 6 Digital power meter
- 7 Control box
- 8 Inverter

Smart measuring systems have a key role to play in the energy networks of the future.

In this context, a smart measuring system comprises a measuring device (smart meter or digital power meter), which records the measurement data, and a communication unit (the smart meter gateway), which transmits the data to the energy provider via a secure connection. A control box, connected to the inverter, can then be used by the energy supply company to control the inverter and thereby regulate the PV system's feed-in.

These smart measuring systems are already mandatory in some countries. Ask your energy supply company what applies to you.

Connecting control box

1. De-energise the inverter's terminal compartment.  **De-energising the inverter, Page 99**

**DANGER****Risk of death due to electrical shock and discharge!**

De-energise device and secure against being switched on again. **De-energising the inverter, Page 99**

2. Fit the control box on the top-hat rail in the control cabinet or power distributor.
 3. Correctly route the communication cable from the inverter to the control cabinet and connect to the control box following the wiring diagram provided by the manufacturer (torque: 0.2 Nm).
 4. Connect the communication cable in the inverter to the terminal for the ripple control receiver. **Connecting ripple control receiver, Page 63**
 5. Connect control box to the smart meter gateway.
- ✓ The control box is connected.

Connecting digital power meter

1. Fit digital power meter in control cabinet or power distributor.
 2. Correctly route the communication cable from the inverter to the control cabinet and connect to the control box following wiring diagram provided by the manufacturer.
 3. Connect the communication cable of the digital power meter to the terminal for the digital energy meter in the inverter (torque: 0.2 Nm) **Energy meter connection, Page 59**
 4. Connect digital power meter to the smart meter gateway.
- ✓ The digital power meter is connected.

Activating active power control in the Webserver

1. Connect inverter and computer. **Connection types, Page 126**
2. Launch an Internet browser.
3. In the browser's address bar, enter the IP address of the inverter to which the control box is connected and confirm with **Return**.

**INFO**

The IP address can be read on the inverter's display.

- The Webserver page is opened.
4. Log into the Webserver as an installer.



1

2

3

4

5

6

7

8

9

10

11

12

13

14

15

5. Go to **Service menu** > **Digital inputs**.
- The "Digital inputs" page opens.
6. Select the "Active power control" function.
7. If the control signals of this ripple control receiver are to be distributed in the local LAN network (home network) by means of UDP, select **Activate the distribution of ripple control signals**. Other inverters can therefore also be controlled using the connected ripple control receiver in the local LAN network.
8. Click on the **Save** button.
- ✓ Active power control is enabled.



1

2

3

4

5

6

7

8

9

10

11

12

13

14

15

10. External battery control

10.1	External battery control	199
10.2	External battery control via Modbus (TCP).....	200
10.3	External battery control via digital inputs.....	202



10.1 External battery control

With external battery control, an external market operator, e.g. an energy supply company, controls the charge/discharge of the battery using an external energy management system.

For example, the energy of the battery can be fed into the public grid as required or charged from the public grid to stabilise it. The battery energy can of course also be used in your own house grid.

Information about the configuration of the external control can be obtained from the relevant service provider (e.g. energy supply company).

The advantage for plant owners is that they receive remuneration from the external supplier for the energy provided, for example.

External battery control can be activated and configured in the Webserver in the Service menu under "Battery settings".

The following control interfaces are available:

- External battery control via Modbus (TCP) **External battery control via Modbus (TCP), Page 200**
- External battery control via digital inputs **External battery control via digital inputs, Page 202**



1

2

3

4

5

6

7

8

9

10

11

12

13

14

15

10.2 External battery control via Modbus (TCP)

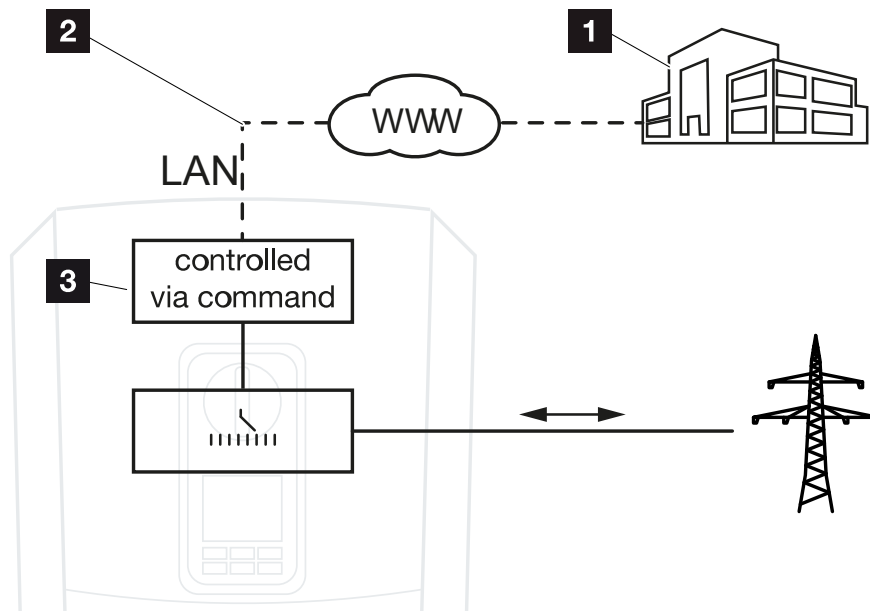

- 1 External energy management system (e.g. energy supply company)
- 2 Control via Modbus (TCP)
- 3 Control electronics of the inverter

If external battery control via Modbus (TCP) is selected, the inverter receives the control signals for charging and discharging the connected battery via Modbus (TCP).

For this purpose, the inverter must be connected to the Internet via Ethernet (LAN).

The internal energy management remains active, but is overridden by the external specifications regarding charging and discharging capacity.

The following commands are possible:

- Charging/discharging of battery via current specified as a percentage or in watts
- Charging/discharging of battery via output specified as a percentage or in watts
- Range specification of a min./max. SoC as percentage

If no external control signals are received for an extended period of time, the inverter returns to internal battery control. The time for this is set in the Webserver. The specifications of the external provider must be observed.

Activate external battery control via Modbus (TCP)

1. Connect inverter and computer. **Connecting the inverter/computer, Page 127**
2. Launch an Internet browser.



1

2

3

4

5

6

7

8

9

10

11

12

13

14

15

3. Call up the Webserver. To do this, enter the IP address of the inverter in the address bar of the Internet browser and confirm with **ENTER**.



INFO

The IP address can be read on the inverter's display.

- The Webserver page is opened.
- 4. Log in to the Webserver as an **installer**.
- 5. Select the **Service menu > Battery settings** menu item.
 - The **Battery settings** page opens.
- 6. Under **Battery control** select the **External via protocol (Modbus TCP)** function.
- 7. Click on the **Save** button.
- ✓ The function is active.



1

2

3

4

5

6

7

8

9

10

11

12

13

14

15

10.3 External battery control via digital inputs

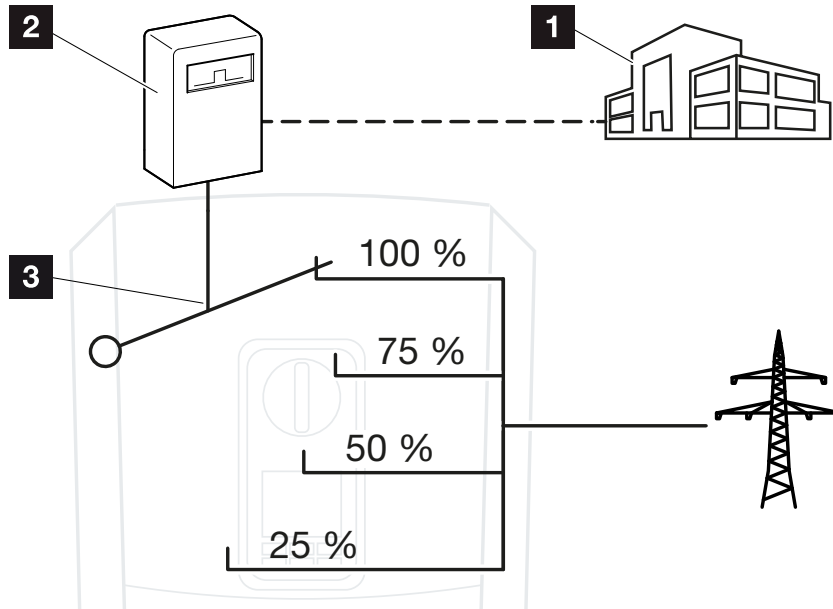

- 1 External energy management system (e.g. energy supply company)
- 2 External control box
- 3 Inverter control electronics

If **External battery control via digital inputs** is selected, the inverter receives the control signals for charging and discharging the connected battery via the digital inputs of the Smart Communication Board (SCB).

It is important that the digital inputs in the Webserver are configured accordingly.

Internal energy management remains active, but is overridden by the external specifications for charging and discharging capacity.

The following commands are possible:

- Charging/discharging of battery via output specified as a percentage

The specifications of the external provider must be observed.

Activating external battery control via digital inputs

1. Connect inverter and computer. **Connecting the inverter/computer, Page 127**
2. Launch an Internet browser.
3. Call up the Webserver. To do this, enter the IP address of the inverter to which the control box is connected in the browser's address bar and confirm with **ENTER**.



1

2

3

4

5

6

7

8

9

10

11

12

13

14

15



INFO

The IP address can be read on the inverter's display.

- The Webserver page is opened.
- 4. Log in to the Webserver as an *installer*.
- 5. Select the **Service menu** > **Battery settings** menu item.
- The **Battery settings** page opens.
- 6. Under **Battery control** select the **External via digital I/O** function.
- 7. Click on the **Save** button.
- ✓ The function is active.

Configuration of digital inputs

1. Go to **Service menu** > **Digital inputs**.
2. The **Digital inputs** page opens.
3. Under Operating mode select the **External battery management** function.
4. Click on the **Save** button.
- ✓ The function is active.



11. System monitoring

11.1	The log data.....	205
11.2	Retrieving, storing and graphically depicting log data	209
11.3	The KOSTAL Solar Portal.....	211

11.1 The log data

The inverter is equipped with a data logger, which regularly records the following data from the system:

- Inverter data
- External energy meter data
- Grid data
- ENS data

For information on how to retrieve, store and graphically display log data, see [Retrieving, storing and graphically depicting log data, Page 209](#).

The log data can be used for the following purposes:

- Check operating characteristics of the system
- Determine and analyse errors
- Download and graphically depict yield data

1	Wechselrichter Logdaten											
2	Wechselrichter 1											
3	Name: scb-sued-oben											
4	akt. Zeit: 1522224361											
5												
6	Logdaten U[V], I[A], P[W], E[kWh], F[Hz], R[kOhm], Ain T[digit], Zeit[sec], Te[C], H[%]											
7	Zeit	DC1 U	DC1 I	DC1 P	DC1 T	DC1 S	DC2 U	DC2 I	DC2 P	DC2 T	DC2 S	DC3 U
8	1520946601	0	0	0	0	0	0	0	0	0	0	0
9	1520946901	27	0	1	0	0	0	0	0	0	2	0
10	1520947201	438	0	13	35	0	2	0	0	0	32	0
11	1520947502	443	0	8	34	0	2	0	0	0	32	0
12	1520947804	443	0	22	34	0	2	0	0	0	32	0
13	1520948105	408	0	71	34	0	2	0	0	0	32	0
14	1520948405	445	0	7	34	0	2	0	0	0	32	0
15	1520948705	419	0	63	34	0	2	0	0	0	32	0
16	1520949005	406	0	77	34	0	2	0	0	0	32	0
17	1520949305	449	0	7	34	0	2	0	0	0	32	0
18	1520949602	426	0	66	34	0	2	0	0	0	32	0
19	1520949902	388	1	212	34	0	1	0	0	0	32	0
20	1520950203	398	0	122	34	0	2	0	0	0	32	0
21	1520950505	433	0	9	34	0	2	0	0	0	32	0
22	1520950805	432	0	13	34	0	2	0	0	0	32	0
23	1520951106	448	0	8	34	0	2	0	0	0	32	0
24	1520951407	443	0	12	34	0	2	0	0	0	32	0
25	1520951708	439	0	8	33	0	2	0	0	0	32	0

- 1 File header
- 2 Physical variables
- 3 Log file entries



1

2

3

4

5

6

7

8

9

10

11

12

13

14

15

Log file: File header

The log file contains a file header with information on the inverter:

Entry	Explanation
<i>Inverter number</i>	Number of the inverter (always 1)
<i>Name</i>	Can be assigned by the user via the browser
<i>Current time</i>	The system time valid at the time the file was created in seconds. This makes allocation possible (e.g. 1372170173 Unix time stamp = 25.06.2013 16:22:53) NOTE! A Unix time stamp converter can be found on-line.

Log file: Physical variables

The file header is followed by the units of the physical variables. The following table explains the abbreviations for the physical variables:

Entry	Explanation
<i>U</i>	Voltage in volts [V]
<i>I</i>	Current strength in milliamps [mA]
<i>P</i>	Power in watts [W]
<i>E</i>	Energy in kilowatt hours [kWh]
<i>F</i>	Frequency in Hertz [Hz]
<i>R</i>	Resistance in kilohms [kOhm]
<i>T</i>	Counting unit in points [digits]
<i>Aln T</i>	Counting unit in points [digits]
<i>Time</i>	Time in seconds [sec] since commissioning
<i>TE</i>	Temperature in degrees Celsius [°C]
<i>H</i>	No function [%]



1

2

3

4

5

6

7

8

9

10

11

12

13

14

15

Log file: Entries

The units of the physical variables are followed by various entries in the log file.

The following table explains the various entries in the log file and may vary depending upon the model:

Entry	Explanation
Time	Time in seconds of the time since the inverter went into operation
DC x U	DC voltage: Input voltage of the relevant string (x = 1, 2 and 3) in V
DC x I	DC current: Input current of the relevant string (x = 1, 2 and 3) in mA
DC x P	DC power: Input power of the relevant string (x = 1, 2 and 3) in W
DC x T	DC temperature: Details for service. Temperature of the respective phase (x = 1, 2 and 3) in digital values
DC x S	DC status: Details for service of the relevant string (x = 1, 2 and 3)
AC x U	AC voltage: Output voltage of the respective phase (x = 1, 2 and 3) in V
AC x I	AC current: Output current of the respective phase (x = 1, 2 and 3) in mA
AC x P	AC power: Output power of the respective phase (x = 1, 2 and 3) in W
AC x T	AC temperature: Details for service. Temperature of the respective phase (1, 2 and 3) in digital values
AC F	AC frequency: Grid frequency in Hz
FC I	Residual current: Measured residual current in mA
Aln1-4	Is not used
AC S	AC status: Details for service of the operational status of the inverter
ERR	General faults
ENS S	Status of the ENS (device for grid monitoring with assigned switching elements):
ENS Err	Status of grid monitoring
SH x P	Faults of the ENS (device for grid monitoring with assigned switching elements)
SC x P	Power of the external current sensor: Power of the respective phase (x = 1, 2 and 3) in W
HC1 P HC2 P HC3 P	Self-consumption at the relevant phase (x = 1, 2 and 3) in W
SOC H	not used
BAT Te	Home consumption in W from the PV modules
BAT Cy	Home consumption in W from the grid
KB S	Battery charging status (SoC = State of charge)



1

2

3

4

5

6

7

8

9

10

11

12

13

14

15

Entry	Explanation
Total E	Battery temperature
OWN E	Number of battery charge cycles
HOME E	Internal communication status when switching to AC grid
Iso R	Total energy in kWh which has been generated by the inverter and is being transferred to the AC grid in the house.
Event	Self-consumption: Energy in kWh currently being consumed in the house, which is covered by the inverter.



11.2 Retrieving, storing and graphically depicting log data

There are several options for retrieving and permanently storing the log data:

Option 1: Download the log data with a computer and display it

1. Call up "Log data" menu in the Webserver. **The Webserver, Page 134**
 2. Select time period (max. 100 days) and confirm with "Download".
- ✓ The log data (logdata.csv) can be saved onto a computer and displayed and further processed with any common spreadsheet program (e.g. Excel).

Option 2: Transfer log data to a solar portal and display it

With a solar portal it is possible to monitor the PV system and performance data via the Internet.

A solar portal has the following functions, which, however, may differ depending upon the portal:

- Graphic depiction of performance data
- Worldwide online access to the portal
- Email notification of errors
- Data export (e.g. Excel file)
- Long-term storage of log data

Prerequisites for data transfer to a solar portal:

- Device has Internet connection
- Registration with a solar portal (e.g. KOSTAL Solar Portal)
- Selection of a solar portal
- Activation of data transfer in the inverter



Activation of data transfer to a solar portal via the control panel



INFO

A correctly set-up network connection/Internet connection is a prerequisite for data transfer.

It may take as much as 20 minutes following activation (dependent upon the portal) until the data export is visible on the solar portal KOSTAL Solar Portal.

The KOSTAL Solar Portal (www.kostal-solar-portal.com) is preset as the standard solar portal.

1. Select the "Settings/information" menu on the control panel of the inverter.
 2. Confirm with the **ENTER** key.
 3. Use the **UP**, **DOWN** and **ENTER** keys to select the menu **Solar Portal > Portal**.
 4. Select a solar portal.
 5. Press and hold down the **ENTER** key.
 6. Select the **Activate** field and confirm with **ENTER**.
- ✓ Data transfer to the solar portal is now enabled. The name of the solar portal is displayed. The data export to the solar portal is being executed.



11.3 The KOSTAL Solar Portal

The solar portal of KOSTAL Solar Electric GmbH is a free Internet platform for monitoring the PV system.

The inverter sends the PV system's yield data and event messages to the solar portal via the internet.

The information is then stored in the solar portal. You can view and call up this information via the Internet.

Prerequisites for using the solar portal

- The inverter must have a connection to the Internet.
- The inverter must not yet be logged onto the solar portal.
- The inverter must not yet be assigned to a plant.

To use the solar portal, follow these two steps:

- Activate data transfer to the solar portal in the inverter. Activation can be performed using the Webserver or the inverter menu.



INFO

If there are multiple inverters in a system, data transfer to the KOSTAL Solar Portal must be set up separately for each inverter and, if necessary, for the KOSTAL Smart Energy Meter.

- Register for free on the KOSTAL Solar Electric GmbH website to use the KOSTAL Solar Portal .



12. Maintenance

12.1	Maintenance and cleaning	213
12.2	Housing cleaning	214
12.3	Fan cleaning	215
12.4	Updating software.....	219
12.5	Event codes.....	222



12.1 Maintenance and cleaning

Once correctly installed, the inverter runs virtually maintenance-free.

The following maintenance tasks are to be carried out for the inverter:

Activity	Interval
Check cable connections and plugs	1x annually
Clean fans  Fan cleaning, Page 215 Then carry out a fan test. The fan test can be started by going to Service menu > Fan test .	1x annually



POSSIBLE DAMAGE

Dirty or blocked fans mean that the inverter is not adequately cooled. Insufficient cooling of the inverter may result in power reduction or the failure of the system.

Always mount inverters in such a way that falling parts cannot fall into the inverter through the ventilation grille.

If no maintenance work is carried out, this will result in an exclusion of warranty (see 'Exclusion of warranty' in our service and warranty conditions).



1

2

3

4

5

6

7

8

9

10

11

12

13

14

15

12.2 Housing cleaning

The housing may only be wiped down with a damp cloth. Abrasive cleaners are not permitted.



12.3 Fan cleaning

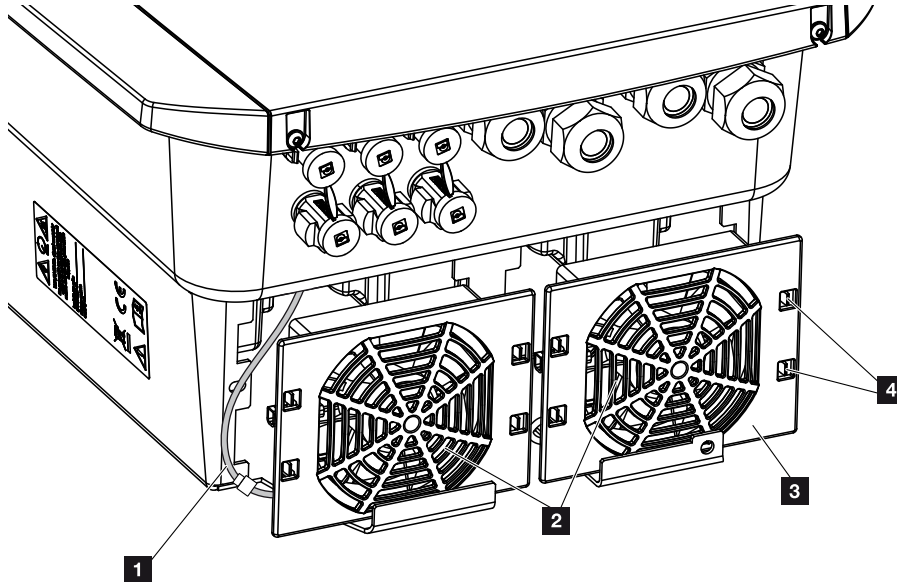

- 1 Fan cable
- 2 Fan
- 3 Fan grille
- 4 Fastening straps

Procedure

The fan may only be removed and cleaned if the inverter is switched off. Otherwise, the fan may start up.

1. Turn the DC switch on the inverter to OFF. **DC switch on the inverter, Page 26**
2. Remove the fan. To do this, place a screwdriver at the edge of the fan grille and apply a little pressure to the fan grille.



1

2

3

4

5

6

7

8

9

10

11

12

13

14

15

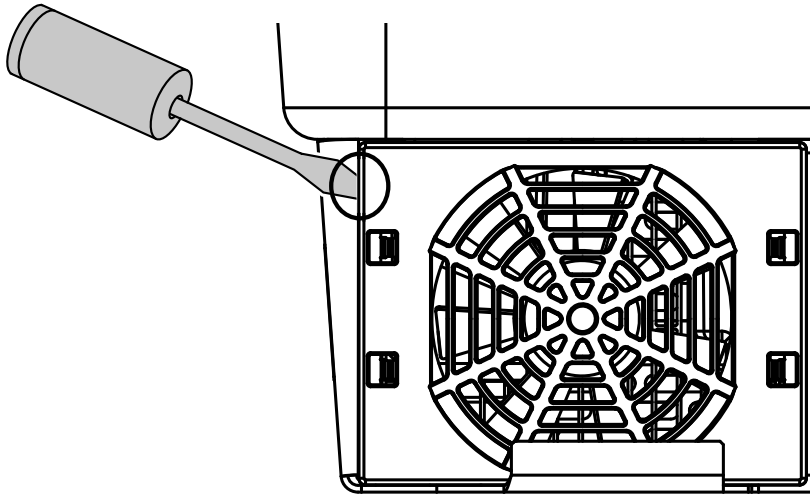

3. With a second screwdriver, press the fastening straps toward the centre of the fan. Pull the fan unit slightly forward.

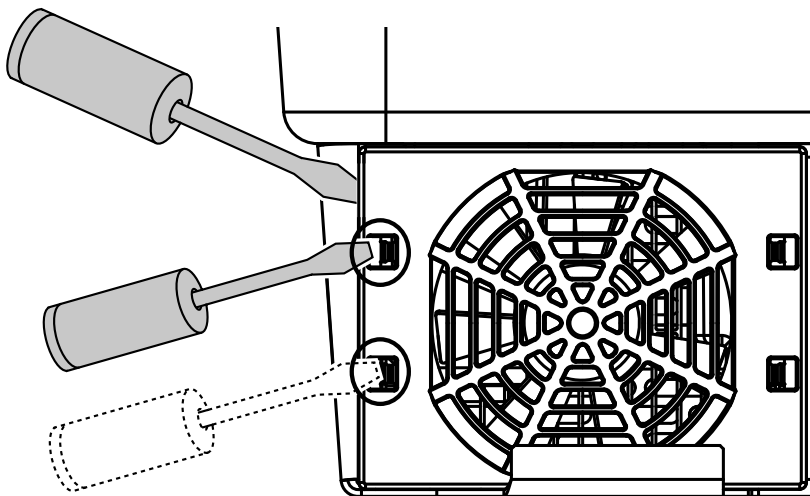

4. Completely remove the fan unit from the housing. To do this, disconnect the plug of the fan cable.

**INFO**

Note how the cable is routed inside the housing.

When installing the fan, the fan cable must be relaid in exactly the same way.



1

2

3

4

5

6

7

8

9

10

11

12

13

14

15

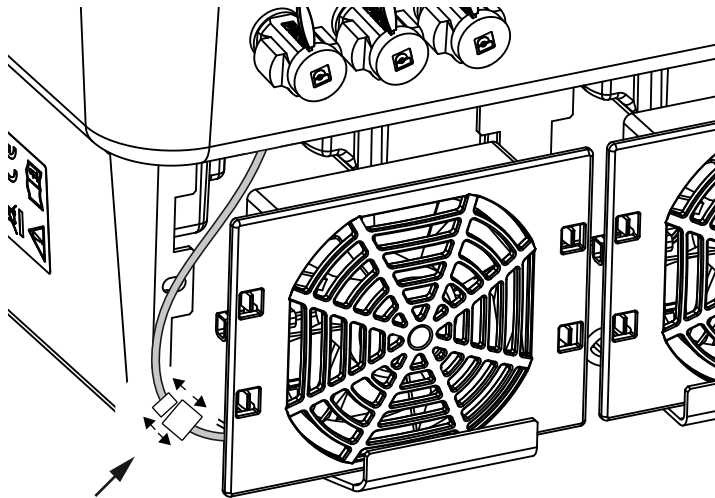

5. The fan can also be pulled off the fan grille. To do this, press the fastening straps slightly outward and pull off the fan.

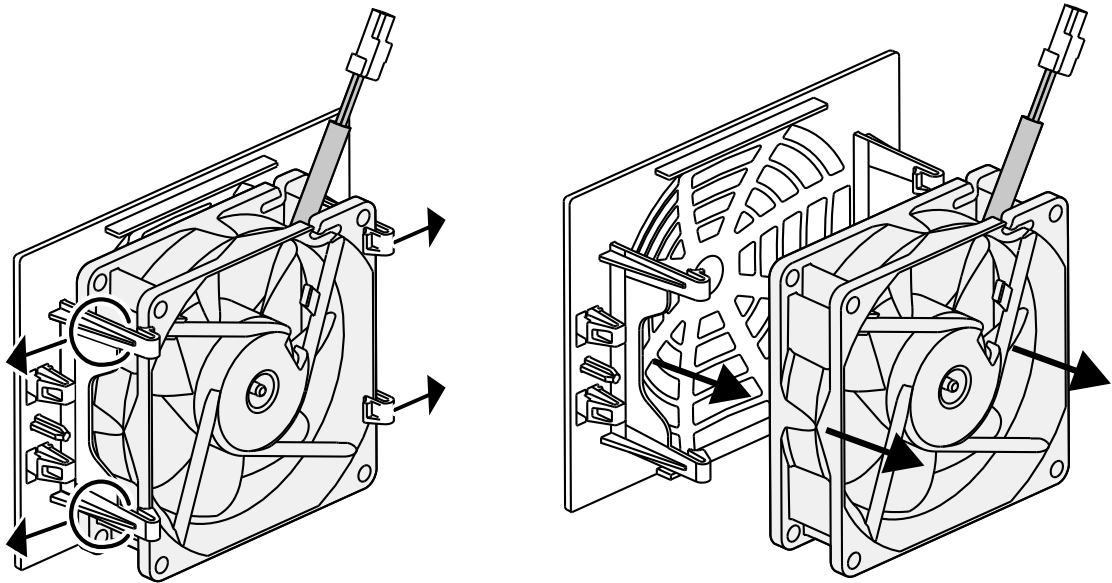

6. Clean fan and housing opening with a soft brush.
7. Note the following when installing the fan:
- The fan has been correctly installed in the fan frame (air flow direction).
 - The cable points into the housing.
 - The cable of the fan is not pinched.



1

2

3

4

5

6

7

8

9

10

11

12

13

14

15

! INFO

When installing the fan ensure that the cables are laid so that they do not run into the fan. If this is not done, the fan may fail or noise may result.

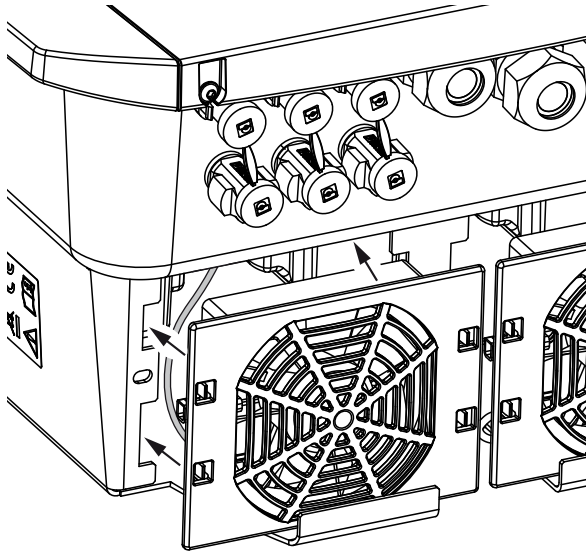

8. Reconnect the fan cable and insert the fan into the housing. When switching on for the first time, check whether the air from the fan is drawn inwards.
 9. Start up the inverter. **Switching on the inverter, Page 97.**
- ✓ Fan cleaning carried out.



1

2

3

4

5

6

7

8

9

10

11

12

13

14

15

12.4 Updating software



- 1 Yellow software update icon: An update is available
- 2 Call up the update menu
- 3 Configure update method:
Manual updates, Find out about updates or Automatic updates
- 4 Check for updates on the Internet
- 5 Manual installation via local update file
- 6 Status line
- 7 Save settings or perform software update

If new software is available for the inverter, it can be updated via the "Update" menu item on the inverter. In the process, the software and the user interface of the Smart Communication Board are brought completely up to date.



1

2

3

4

5

6

7

8

9

10

11

12

13

14

15

Update methods

If a software update is available, it can be updated on the inverter using three methods:

Under **Update** > **System Update** you can choose between these three update methods. The selection must then be confirmed with the "Save" button.

Manual updates

The inverter is updated manually. Information on this can be found under "Performing a manual update".

Find out about new updates

(Inverter must be connected to the Internet.)

The inverter checks at regular intervals whether a software update is available. You can see whether this is the case by the symbol (1) in the header.

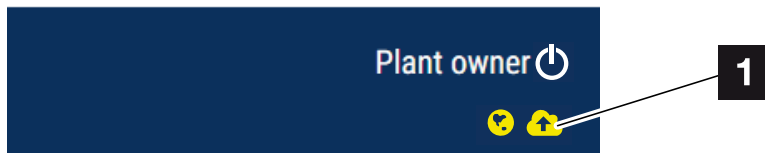

1 Yellow: A software update is available.

Grey: No software update is available.

The update of the inverter can be started in the **Update** menu via the **Execute** button.

Automatic updates (recommended)

(Inverter must be connected to the Internet.)

If this is selected, a new software update is installed on the inverter as soon as it is available.



Perform manual update

Updating the inverter using the Webserver is a very simple process.

1. Call up the Webserver. **Accessing the Webserver, Page 137**
2. Go to **Update**.
3. If the inverter is connected to the Internet, use the **Look for updates** function.
If the inverter has no connection to the Internet, download the update for the inverter from the manufacturer's website to your computer. Click on the **Select upload file** button and select the update file (*.swu) on the computer or drag the update file into the field.



INFO

You can find the latest update in the download area for the product on our website at www.kostal-solar-electric.com

4. Start the installation using **Execute**.
→ The inverter recognises the update file and starts the installation.
5. If you want to install the software update, confirm with **OK**.
→ The software update is installed on the inverter. Once the software update has been installed, the inverter is restarted. It can take up to 10 minutes for the inverter to restart. Following the update, the installer's display shows that the installation has been successful.



INFO

Following a successful software update, the inverter automatically returns to feed-in mode.

6. Once the software update has been successfully installed, the current software version can be queried on the inverter or Webserver.
This is done in the inverter's menu by going to: **Settings/information > Device information** or in the Webserver by going to **Info**.
✓ The update has been installed.



12.5 Event codes

There is no need to take action when an event occurs occasionally or only briefly and the device resumes operation. When an event lasts for long periods or recurs frequently, the cause must be determined and rectified.

A list of the current event codes and measures can be found in the document **Ereignisliste/Event list**, which can be found in the download area for your product.



1

2

3

4

5

6

7

8

9

10

11

12

13

14

15

13. Technical data

13.1	Technical data	224
13.2	Block diagram.....	228



1

2

3

4

5

6

7

8

9

10

11

12

13

14

15

13.1 Technical data

Subject to technical changes. Errors excepted.

You can find current information at www.kostal-solar-electric.com.

Power class

Hybrid inverters	Unit	PLENTICORE plus G2					
Power class		3.0	4.2	5.5	7.0	8.5	10

Input side (DC)

PLENTICORE plus G2	Unit	3.0	4.2	5.5	7.0	8.5	10
Max. PV power (cos $\phi = 1$)	kWp	4.5	6.3	8.25	10.5	12.75	15
Max. PV power per DC input	kWp	6.5					
Nominal DC power	kW	3.09	4.33	5.67	7.22	8.76	10.31
Rated input voltage (U _{dc,r})	V	570					
Start input voltage (U _{dc,start})	V	150					
Input voltage range (U _{dc,min})	V	120					
Input voltage range (U _{dc,max})	V	1000					
MPP working voltage range (U _{mpp,work-min})	V	120					
MPP working voltage range (U _{mpp,work-max})	V	720					
Max. working voltage (U _{dc,workmax})	V	900					
Max. input current (i _{dc, max}) per DC input	A	13					
Max. PV short-circuit current (I _{sc,pv}) per DC input	A	16.25					
Number of DC inputs		3					
Number of DC inputs for battery (optional)		1					
Number of independent MPP trackers		3					

Input side (DC3 battery input)

PLENTICORE plus G2	Unit	3.0	4.2	5.5	7.0	8.5	10
Battery input min. working voltage range (U _{dc,workbatmin})	V	120					
Battery input max. working voltage range (U _{dc,workbatmax})	V	650					
Battery input max. charge/discharge current	A	13/13					

Output side (AC)

PLENTICORE plus G2	Unit	3.0	4.2	5.5	7.0	8.5	10
Rated power, cos $\phi = 1$ (P _{ac,r})	kW	3	4.2	5.5	7	8.5	10



1

2

3

4

5

6

7

8

9

10

11

12

13

14

15

PLENTICORE plus G2	Unit	3.0	4.2	5.5	7.0	8.5	10
Output apparent power (S _{ac,nom} , S _{ac,max})	kVA	3	4.2	5.5	7	8.5	10
Min. output voltage (U _{ac,min})	V	320					
Max. output voltage (U _{ac,max})	V	500					
Rated output current (I _{ac,r})	A	4.33	6.06	7.94	10.1	12.27	14.43
Max. output current (I _{ac,max})	A	4.81	6.74	8.82	11.23	13.63	16.04
Inrush current (I _{lrush})	A	2.46			6.72		
Short-circuit current (peak/RMS)	A	6.8/4.8	9.5/6.7	12.5/8.8	15.9/11.2	19.3/13.6	22.8/16.1
Number of feed-in phases		3					
Grid connection		3N~, 230/400 V, 50 Hz					
Rated frequency (f _r)	Hz	50					
Grid frequency (f _{min} - f _{max})	Hz	47/53					
Setting range for the power factor (cos φ _{AC,r})		0.8...1...0.8					
Power factor at rated power (cos φ _{AC,r})		1					
THD	%	3					

Unit characteristics

PLENTICORE plus G2	Unit	3.0	4.2	5.5	7.0	8.5	10
Standby	W	7.9					

Efficiency

PLENTICORE plus G2	Unit	3.0	4.2	5.5	7.0	8.5	10
Max. efficiency	%	97.1		97.2		97.1	
European efficiency	%	95.3	96.5		95.5	96.2	96.5
MPP adjustment efficiency	%	99.9					

System data

PLENTICORE plus G2	Unit	3.0	4.2	5.5	7.0	8.5	10
Topology: Without galvanic isolation – transformerless		Yes					
Protection class in accordance with IEC 60529		IP 65					
Protective class according to IEC 62103		I					
Overvoltage category according to IEC 60664-1 on input side (PV generator)		II					
Overvoltage category according to IEC 60664-1 on output side (grid connection)		III					
Degree of contamination		4					
Environmental category (outdoor installation)		Yes					
Environmental category (indoor installation)		Yes					



1

2

3

4

5

6

7

8

9

10

11

12

13

14

15

PLENTICORE plus G2	Unit	3.0	4.2	5.5	7.0	8.5	10
UV resistance		Yes					
AC cable diameter (min-max)	mm	8...17					
AC cable cross-section (min-max)	mm ²	1.5...6			2.5...6		4...6
PV cable cross-section (min-max)	mm ²	2.5...6					
Battery cable cross-section (min-max)	mm ²	4...6					
Torque of screws in terminal compartment	Nm	2					
Torque of screws in cover	Nm	1.5					
Max. fuse protection on output side (AC) IEC 60898-1	A	B16 / C16	B25 / C25				
Compatibility with external residual current protection devices		Type A RCD					
Internal operator protection in accordance with EN 62109-2		Yes					
Independent disconnection device accord- ing to VDE V 0126-1-1		Yes					
Electronic DC disconnection device integ- rated		Yes					
Reverse polarity protection, DC side		Yes					
Height/width/depth	mm	563 / 405 / 233					
Weight	kg	19.6	21.6				
Cooling principle – regulated fans		Yes					
Max. air throughput	m ³ /h	184					
Noise emission (typical)	dB(A)	39					
Ambient temperature	°C	-20...60					
Max. operating altitude above sea level	m	2000					
Relative humidity	%	4...100					
Connection technology, DC side		SUNCLIX plug					
Connection technology, AC side		Spring-type terminal strip					
Connection technology, COM		Push-in terminals					

Interfaces

PLENTICORE plus G2	Unit	3.0	4.2	5.5	7.0	8.5	10
Ethernet (RJ45/100 Mbit/s)		2					
Wi-Fi (2.4 GHz [IEEE 802.11 b/g/n])		Yes					
RS485/CAN (for battery communication)		1					
Energy meter connection for collecting en- ergy data (Modbus RTU)		1					
Digital inputs		Yes (e.g. for ripple control receiver or external battery control, CEI, OVP evaluation)					
Digital outputs		4 (24 V, 100 mA)					
Webserver (user interface)		Yes					



1

2

3

4

5

6

7

8

9

10

11

12

13

14

15

Directives / Certification

Directives / Certification

CE, GS, CEI 0-21, CEI10/11, EN 62109-1, EN 62109-2, EN 60529, EN 50438*, EN 50549-1*, NA/EEA, G98, G99, IFS2018, IEC 61727, IEC 62116, RD 1699, RFG, TF3.3.1, TOR generators, UNE 206006 IN, UNE 206007-1 IN, UTE C15-712-1, VDE 0126-1-1, VDE-AR-N 4105, VJV2018 (* does not apply to all national annexes)

Noise emission: Measured under rated output at an ambient temperature of 23 °C. If a string connection is unfavourable or there is a higher ambient temperature, the noise emission may be up to 48 dB(A).

MPP working voltage range: MPP range 120 V to 180 V (with limited current of 9.5-13 A) to 680 V to 720 V (with limited current of 11 A). A detailed layout should be produced using the KOSTAL Solar Plan user software.

Automatic disconnection device in accordance with VDE V 0126-1-1, for Austria: The inverter is equipped "with automatic disconnection device in accordance with ÖVE/ÖNORM E 8001-4-712".

Overvoltage category II (DC input): The device is suitable for connection to PV strings. Long feed cables out of doors or a lightning protection system in the vicinity of the PV system may make lightning protection or surge protection equipment necessary.

Overvoltage category III (AC output): The device is suitable for permanent connection in the grid distribution behind the meter and the line protection fuse. If the connection cable travels outdoors over long distances, overvoltage protection devices may be necessary.

Degree of contamination 4: Contamination results in continuous conductivity, e.g. due to conductive dust, rain or snow; indoors or outdoors.

13.2 Block diagram

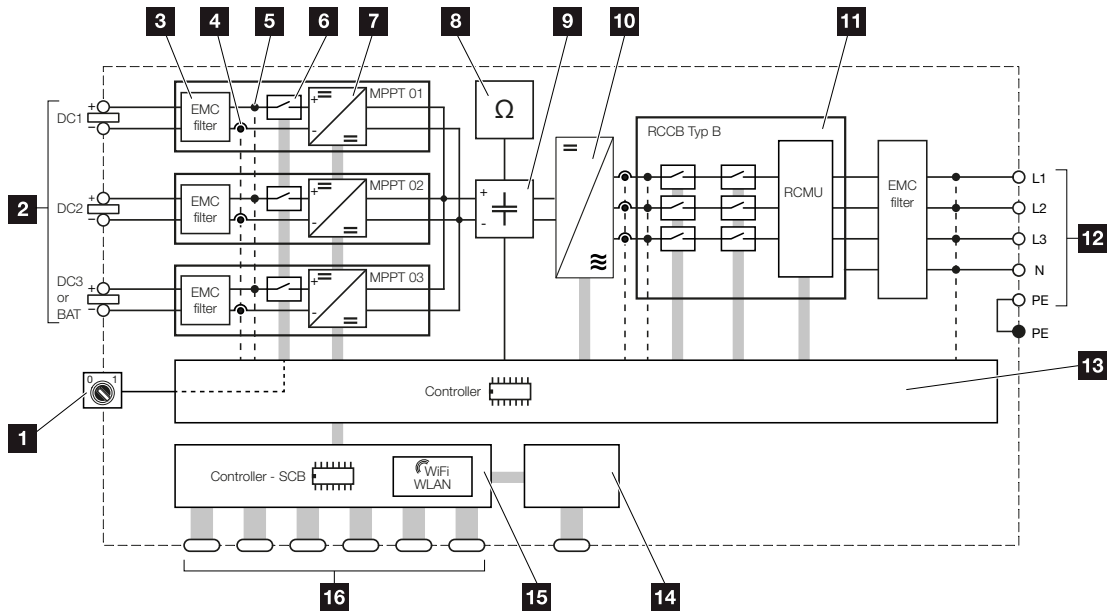

- 1 DC switch
- 2 DC input
- 3 Electromagnetic compatibility (EMC) filter
- 4 Current measuring point
- 5 Voltage measuring point
- 6 Electronic DC disconnection device
- 7 DC regulator
- 8 Insulation monitoring
- 9 Intermediate circuit
- 10 Inverter bridge
- 11 Grid monitoring and shutdown
- 12 3-phase AC output
- 13 System control with MPP trackers
- 14 Display
- 15 Smart Communication Board (SCB)
- 16 Interfaces (e.g. Ethernet, USB, energy meter)



14. Accessories

14.1	KOSTAL Solar Portal.....	230
14.2	KOSTAL Solar App	231
14.3	KOSTAL Solar Plan configuration software.....	232
14.4	Activating battery connection	233



1

2

3

4

5

6

7

8

9

10

11

12

13

14

15

14.1 KOSTAL Solar Portal

The KOSTAL Solar Portal allows operation of the inverters to be monitored via the Internet. This protects your investment in a PV system against yield losses, e.g. through active e-mail alerts if events occur.

Registering for the KOSTAL Solar Portal is free of charge at www.kostal-solar-portal.com.

Functions include:

- Worldwide online access to the portal
- Graphic representation of the power and yield data
- Visualisation of data and thus being made aware of how to optimise self-consumption
- Notification of events by e-mail
- Data export
- Sensor evaluation
- Display and proof of a potential active power reduction by the grid operator
- Storage of log data for long-term and reliable monitoring of your PV system
- Providing system data for the KOSTAL Solar App

Additional information about this product is available on our website

www.kostal-solar-electric.com under **Products > Monitoring software > KOSTAL Solar Portal**.





1

2

3

4

5

6

7

8

9

10

11

12

13

14

15

14.2 KOSTAL Solar App

The free KOSTAL Solar App offers you professional monitoring of your photovoltaic system. You can use the KOSTAL Solar App to simply and easily access all functions on your smartphone or tablet at any time.

To set up and use the app, you will need access to the KOSTAL Solar Portal and to have an inverter set up there. To log in to the app, you will need to use the same access data as for the KOSTAL Solar Portal.

You can use the KOSTAL Solar App to easily monitor your photovoltaic system and to display relevant system data both at home and when you are out and about. It allows you to access the consumption and generation data over various time periods, such as day, week, month and year, and to view your photovoltaic system's historical data. This means that with the KOSTAL Solar App you are always up to date.

Download the free KOSTAL Solar App today and benefit from new and advanced functionalities.

Additional information about this product is available on our website

www.kostal-solar-electric.com under **Products > Monitoring software > KOSTAL Solar App**.



KOSTAL Solar App





14.3 KOSTAL Solar Plan configuration software

Our free KOSTAL Solar Plan software simplifies the inverter layout process.

Just enter the system data and individual customer data and receive a recommendation for a KOSTAL solar inverter tailored to the planned solar system. All KOSTAL solar inverters are considered for this. In addition, the customer's electricity consumption is considered and the possible self-consumption and potential self-sufficiency quotas are displayed using standard load profiles.

Self-consumption and potential self-sufficiency are displayed.

The KOSTAL Solar Plan covers the following areas of the inverter layout:

- **Rapid layout**

Manual inverter layout taking account of the inverter specifications

- **Layout**

Automatic PV inverter layout with possible consideration of power consumption.

- **Storage layout**

Automatic hybrid/storage inverter layout with possible consideration of power consumption.

As well as providing an improved inverter layout, the KOSTAL Solar Plan also supports preparing quotations. Customer, project and installer data is added to the technical data entered by the user and is included with the quotation as a PDF overview. The planning data can also be saved in a project file and edited if required.

You can find additional information about this product on our website

www.kostal-solar-electric.com in the section **Installer portal**.





1

2

3

4

5

6

7

8

9

10

11

12

13

14

15

14.4 Activating battery connection

For the inverter, it is possible to release the third PV input (DC3) as a connection for battery storage. To do this, you can purchase a battery activation code from our KOSTAL Solar Webshop and enter this in the inverter. You can then use the third PV input to connect a battery.

You can find more information about this product on our website

www.kostal-solar-electric.com.

You will find a list of approved batteries in the download area for the inverter.

Should you have any further questions, please contact our sales team or your service partner.

- Purchase battery activation code from the KOSTAL Solar Webshop .
- Enter battery activation code in inverter or via the Webserver.
- Connect battery to third PV input (DC3) on inverter. **☑ Connecting battery, Page 74**
- Select the settings for the battery in the Webserver.



15. Appendix

15.1	Type plate.....	235
15.2	Warranty and service	237
15.3	Handover to the operator.....	238
15.4	Decommissioning and disposal.....	239



1

2

3

4

5

6

7

8

9

10

11

12

13

14

15

15.1 Type plate

The type plate is located on the device. You will find the device type and the most important technical data listed on the type plate.

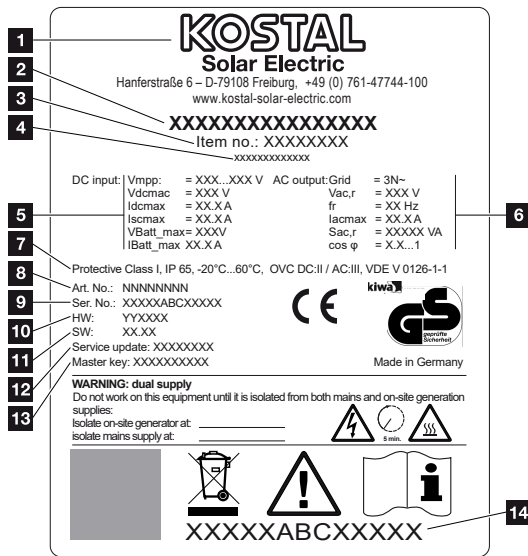

- 1 Name and address of manufacturer
- 2 Device type
- 3 Article number
- 4 Additional designation (e.g. service device)
- 5 Details of the DC input:
 - MPP control range
 - max. DC input voltage
 - max. DC input current
 - max. DC short-circuit current
 - max. DC battery input voltage
 - max. DC battery input current
- 6 Details of the AC output:
 - number of feed-in phases
 - output voltage (nominal)
 - grid frequency
 - max. AC output current
 - max. AC power
 - setting range of power factor
- 7 Protective class in accordance with IEC 62103, protection class, ambient temperature range, overvoltage category, requirements with which the integrated grid monitoring complies



1

2

3

4

5

6

7

8

9

10

11

12

13

14

15

- 8 Internal article number
- 9 Serial number
- 10 Version number of the hardware
- 11 Version number of the software
- 12 Date of the last update (for service devices only)
- 13 Master key password for installer's Webserver login
- 14 Removable warranty label



15.2 Warranty and service

Information about the service and warranty conditions can be found in the download area for the product at www.kostal-solar-electric.com.

For service information and in the event of parts being needed, we require your device type and the serial number. You will find this information on the type plate on the exterior of the housing.

If you have any technical questions, please call our service hotline:

- Germany and other countries (language: German, English):
+49 (0)761 477 44-222
- Switzerland:
+41 32 5800 225
- France, Belgium, Luxembourg:
+33 16138 4117
- Greece:
+30 2310 477 555
- Italy:
+39 011 97 82 420
- Poland:
+48 22 153 14 98
- Spain, Portugal (language: Spanish, English):
+34 961 824 927

Spare parts

If spare parts or accessories are required for troubleshooting, use only original spare parts and accessories manufactured and/or approved by the manufacturer.



15.3 Handover to the operator

Following successful installation and commissioning, all documents are to be handed over to the operator.

Instruct the operator in how to use the PV system and the inverter.

The operator must be made aware of the following points:

- Position and function of the DC switch
- Position and function of the AC line circuit breaker
- Procedure for disconnecting the device
- Safety when handling the device
- Appropriate procedure when checking and servicing the unit
- Meaning of the LEDs and the display messages
- Contact person in the event of a fault
- The provision of system and inspection documentation in accordance with DIN EN 62446 (VDE 0126-23) (optional).

As the **installer and commissioning engineer**, have the operator confirm the proper handover with their signature.

As the **operator**, have the installer and commissioning engineer confirm that the installation of the inverter and the PV system is safe and complies with standards with their signature.



15.4 Decommissioning and disposal

To remove the inverter, proceed as follows:

1. De-energise inverter on AC and DC side.  **De-energising the inverter, Page 99** 



DANGER

Risk of death due to electrical shock and discharge!

De-energise device and secure against being switched on again.  **De-energising the inverter, Page 99**

2. Open the inverter cover.
 3. Loosen terminals and cable glands.
 4. Remove all DC cables, AC cables and communication cables.
 5. Close the inverter cover.
 6. Loosen the screw underneath the inverter.
 7. Loosen screws on top of inverter.
 8. Lift the inverter off the wall.
- ✓ Inverter dismantled

Proper disposal

Electronic equipment labelled with a dustbin with a line through it may not be disposed of with household waste. This equipment can be handed in to waste collection points free of charge.



Find out about the local requirements for the separate collection of electrical and electronic equipment in your country.

