



SDM630-Modbus

DIN Rail Smart Meter for Single and Three Phase Electrical Systems



- Measures kWh Kvarh, KW, Kvar, KVA, P, F, PF, Hz, dmd, V, A, etc.
- Bi-directional measurement IMP & EXP
- Two pulse outputs
- RS485 Modbus
- Din rail mounting 35mm
- 100A direct connection
- Better than Class 1 / B accuracy

USER MANUAL

2016 V5.5

Address: No.1369 Chengnan Road, Jiaxing, Zhejiang, 314001, China.

Tel: 0086-573-83698881/83698882 Fax: 0086-573-83698883 Web: www.eastron.com.cn

Introduction

The SDM630-Modbus measures and displays the characteristics of single phase two wires (1p2w), three phase three wires (3p3w,) and three phase four wires(3p4w) supplies, including voltage, frequency, current, power ,active and reactive energy, imported or exported. Energy is measured in terms of kWh, kVAh. Maximum demand current can be measured over preset periods of up to 60 minutes. In order to measure energy, the unit requires voltage and current inputs in addition to the supply required to power the product.

SDM630-Modbus supports max. 100A direct connection, saves the cost and avoid the trouble to connect external CTs, giving the unit a cost-effective and easy operation. Built-in interfaces provides pulse and RS485 Modbus RTU outputs. Configuration is password protected.

Unit Characteristics

The Unit can measure and display:

- Line voltage and THD% (total harmonic distortion) of all phases
- Line Frequency
- Currents, Current demands and current THD% of all phases
- Power, maximum power demand and power factor
- Active energy imported and exported
- Reactive energy imported and exported

The unit has password-protected set-up screens for:

- Changing password
- Supply system selection 1p2w, 3p3w,3p4w
- Demand Interval Time(DIT)
- Reset for demand measurements
- Pulse output duration

Two pulse output indicates real-time energy measurement. An RS485 output allows remote monitoring from another display or a computer.

RS485 Serial – Modbus RTU

This uses an RS485 serial port with Modbus RTU protocol to provide a means of remotely monitoring and controlling the Unit



Set-up screens are provided for setting up the RS485 port.

Pulse output

This provides two pulse outputs that clock up measured active and reactive energy. The constant of pulse output 2 for active energy is 400imp/kWh (unconfigurable), its width is fixed at 100ms.

The default constant of configurable pulse output 1 is 400imp/kWh, default pulse width is 100ms.The configurable pulse output 1 can be set from the set-up menu.





Start-up Screens

1		The first screen lights up all display segments and can be used as a display check
2		The second screen indicates the firmware installed in the unit and its build number.
3		The interface performs a self-test and indicates the result if the test passes.

After a short delay, the screen will display active energy measurements.





Measurements

The buttons operate as follows:

1		Selects the Voltage and Current display screens In Set-up Mode, this is the “Left” or “Back” button.
2		Select the Frequency and Power factor display screens In Set-up Mode, this is the “Up” button
3		Select the Power display screens In Set-up Mode, this is the “Down” button
4		Select the Energy display screens In Set-up mode, this is the “Enter” or “Right” button



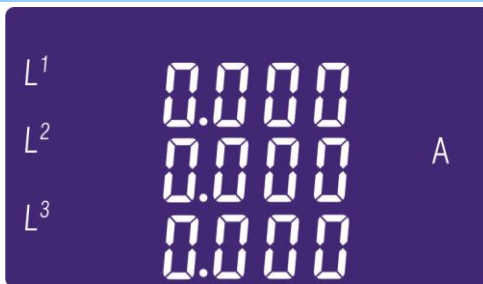

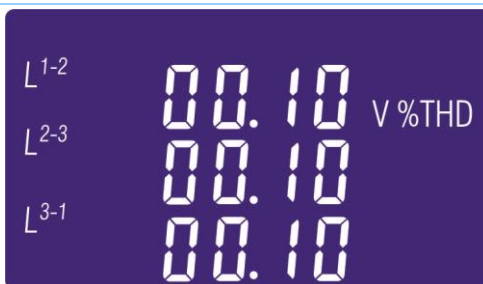
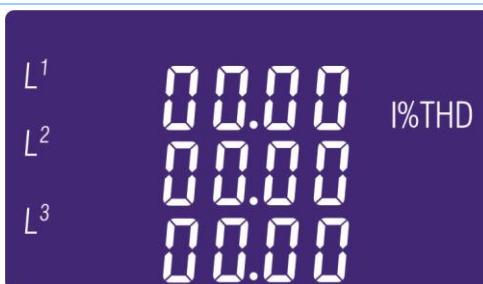
Voltage and Current

Each successive pressing of the  button selects a new range:

1-1		Phase to neutral voltages(3p4w)
1-2		Phase to neutral voltages(3p3w)
2		Current on each phase
3-1		Phase to neutral voltage THD%(3p4w)
3-2		Phase to neutral voltage THD%(3p3w)
4		Current THD% for each phase

Frequency and Power factor and Demand



Each successive pressing of the  button selects a new range:

1		Frequency and Power Factor (total)
2		Power Factor of each phase
3		Maximum Power Demand
4		Maximum Current Demand

Power



Each successive pressing of the  button select a new range:





1		Instantaneous Active Power in kW
---	---	----------------------------------

2		Instantaneous Reactive Power in kVAr
3		Instantaneous Volt-amps in KVA
4		Total kW, kVArh, kVA

Energy Measurements

Each successive pressing of the  button selects a new range:

1-1		Imported active energy in kWh
1-2		Exported active energy in kWh

2-1		Imported reactive energy in kVArh
2-2		Exported reactive energy in kVArh
3-1		Total active energy in kWh
3-2		Total reactive energy in kVArh

Set-up

To enter set-up mode, pressing the  button for 3 seconds, until the password screen appears.



Setting up is password-protected so you must enter the correct password (default '1000') before processing. If an incorrect password is entered, the display will show: Err













To exit setting-up mode, press  repeatedly until the measurement screen is restored.

Set-up Entry Methods



Some menu items, such as password, require a four-digit number entry while others, such as supply system, require selection from a number of menu options.

Menu Option Selection

- 1) Use the  and  buttons to select the required item from the menu. Selection does not roll over between bottom and top of list
- 2) Press  to confirm your selection
- 3) If an item flashes, then it can be adjusted by the  and  buttons. If not, there maybe a further layer.
- 4) Having selected an option from the current layer, press  to confirm your selection. The SET indicator will appear.
- 5) Having completed a parameter setting, press  to return to a higher menu level. The SET indicator will be removed and you will be able to use the  and  buttons for further menu selection.
- 6) On completion of all set-up, press  repeatedly until the measurement screen is restored.







Number Entry Procedure

When setting up the unit, some screens require the entering of a number. In particular, on entry to the setting up section, a password must be entered. Digits are set individually, from left to right. The procedure is as follows:

- 1) The current digit to be set flashes and is set using the  and  buttons
- 2) Press  to confirm each digit setting. The SET indicator appears after the last digit has been set.

3) After setting the last digit, press  to exit the number setting routine. The SET indicator will be removed.











Change password

1		<p>Use the  and  to choose the change password option</p>
2-1		<p>Press the  to enter the change password routine. The new password screen will appear with the first digit flashing</p>
2-2		<p>Use  and  to set the first digit and press  to confirm your selection. The next digit will flash.</p>
2-3		<p>Repeat the procedure for the remaining three digits</p>
2-4		<p>After setting the last digit, SET will show.</p>







Press  to exit the number setting routine and return to the Set-up menu. SET will be removed

DIT Demand Integration Time

This sets the period in minutes over which the current and power readings are integrated for maximum demand measurement. The options are: 0, 5, 8, 10, 15, 20, 30, 60 minutes









1		<p>From the set-up menu, use  and  buttons to select the DIT option. The screen will show the currently selected integration time.</p>
2-1		<p>Press  to enter the selection routine. The current time interval will flash</p>
2-2		<p>Use  and  buttons to select the time required.</p>
2-3		<p>Press  to confirm the selection. SET indicator will appear.</p>
<p>Press  to exit the DIT selection routine and return to the menu.</p>		



Backlit set-up

1		<p>The backlit lasting time is settable Default lasting time is 60minutes For example, if it's set as 5, the backlit will be off in 5minutes from the last time operation on the meter.</p>
2		<p>Press  to enter the selection routine. The current time interval will flash The options can be: 0(always on),5,10,30,60,120minutes</p>
<p>Use  and  buttons to select the time required. Press  to confirm the set-up,</p>		

Supply System

Use this section to set the type of power supply being monitored.

1		<p>From the Set-up menu, use  and  buttons to select the System option. The screen will show the currently selected power supply.</p>
2-1		<p>Press  to enter the selection routine. The current selection will flash</p>
2-2		<p>Use  and  buttons to select the required system option: 1P2(W),3P3(W) ,3P4(W)</p>

2-3		Press  to confirm the selection. SET indicator will appear.
Press  to exit the system selection routine and return to the menu. SET will disappear and you will be returned to the main Set-up Menu		

Pulse output











This option allows you to configure the pulse output 1. The output can be set to provide a pulse for a defined amount of energy active or reactive.

Use this section to set up the pulse output for:

Total kWh/ Total kVArh

Import kWh/Export kWh

Import KVArh/Export KVArh

1		From the Set-up menu, use  and  buttons to select the Pulse output option.
2-1		Press  to enter the selection routine. The unit symbol will flash.
2-2		Use  and  buttons to choose kWh or kVArh.
On completion of the entry procedure, press  to confirm the setting and press  to return to the main set up menu.		

Pulse rate

Use this to set the energy represented by each pulse. Rate can be set to 1 pulse per dFt/0.01/0.1/1/10/100kWh/kVArh.



(It shows 1 impulse = 10kWh/kVArh)









1		<p>From the Set-up menu, use and buttons to select the Pulse Rate option.</p>
2		<p>Press to enter the selection routine. The current setting will flash. Note: When it's dFt, it means 2.5Wh/VArh</p>
<p>Use and buttons to choose pulse rate. On completion of the entry procedure, press to confirm the setting and press to return to the main set up menu.</p>		

Pulse Duration

The energy monitored can be active or reactive and the pulse width can be selected as 200, 100(default) or 60ms.



(It shows pulse width of 200ms)

1-1		<p>From the Set-up menu, use  and  buttons to select the Pulse width option.</p>
1-2		<p>Press  to enter the selection routine. The current setting will flash.</p>
<p>Use  and  buttons to choose pulse width. On Completion of the entry procedure, press  to confirm the setting and press  to return to the main set up menu.</p>		



Communication





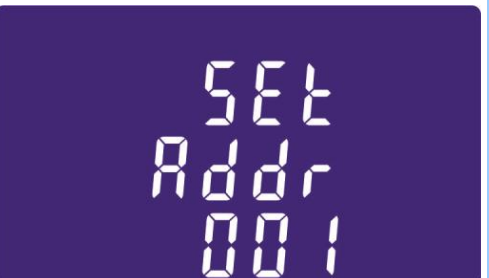

There is a RS485 port can be used for communication using Modbus RTU protocol. For Modbus RTU, parameters are selected from Front panel.

RS485 Address











(The range is from 001 to 247)

1		<p>From the Set-up menu, use  and  buttons to select the Address ID</p>
---	---	---

2-1		<p>Press  button to enter the selection routine. The current setting will be flashing.</p>
2-2		<p>Use  and  buttons to choose Modbus Address(001 to 247)</p>
<p>On completion of the entry procedure, press  button to confirm the setting and press  button to return the main set-up menu.</p>		

Baud Rate

1		<p>From the Set-up menu, use  and  buttons to select the Baud Rate option.</p>
2-1		<p>Press  to enter the selection routine. The current setting will flash.</p>
2-2		<p>Use  and  buttons to choose Baud rate 2.4k, 4.8k, 9.6k, 19.2k, 38.4k</p>
<p>On completion of the entry procedure, press  to confirm the setting and press</p>		









to return to the main set up menu.

Parity

1		<p>From the Set-up menu, use and buttons to select the Parity option.</p>
2-1		<p>Press to enter the selection routine. The current setting will flash.</p>
2-2		<p>Use and buttons to choose Parity (EVEN / ODD / NONE)</p>
<p>On Completion of the entry procedure, press to confirm the setting and press to return to the main set up menu.</p>		

Stop bits







1		<p>From the Set-up menu, use and buttons to select the Stop Bit option.</p>
---	--	---

2-1		Press  to enter the selection routine. The current setting will flash.
2-2		Use  and  buttons to choose Stop Bit (2 or 1)
On completion of the entry procedure, press  to confirm the setting and press  to return to the main set up menu.		

Note: Default is 1, and only when the parity is NONE that the stop bit can be changed to 2.

CLR

The meter provides a function to reset the maximum demand value of current and power.

1		From the Set-up menu, use  and  buttons to select the reset option.
2		Press  to enter the selection routine. The MD will flash.
Press  to confirm the setting and press  to return to the main set up menu.		

Specifications

Measured Parameters

The unit can monitor and display the following parameters of a single phase two wire(1p2w), three phase three wire(3p3w) or four phase four wire(3p4w) supply.

Address: No.1369 Chengnan Road, Jiaxing, Zhejiang, 314001, China.

Voltage and Current

Phase to neutral voltages 100 to 289V a.c. (not for 3p3w supplies)
Voltages between phases 173 to 500V a.c. (3p supplies only)
Percentage total voltage harmonic distortion (THD%) for each phase to N (not for 3p3w supplies)
Percentage voltage THD% between phases (three phase supplies only)
Current THD% for each phase

Power factor and Frequency and Max. Demand

Frequency in Hz
Instantaneous power:
 Power 0 to 99999 W
 Reactive Power 0 to 99999 VAR
 Volt-amps 0 to 99999 VA
Maximum demanded power since last Demand reset Power factor
Maximum neutral demand current, since the last Demand reset (for 3p4w supply only)

Energy Measurements

- Imported active energy 0 to 999999.99 kWh
- Exported active energy 0 to 999999.99 kWh
- Imported reactive energy 0 to 999999.99 kVAh
- Exported reactive energy 0 to 999999.99 kVAh
- Total active energy 0 to 999999.99 kWh
- Total reactive energy 0 to 999999.99 kVAh

Measured Inputs

Voltage inputs through 4-way fixed connector with 25mm² stranded wire capacity. single phase two wire(1p2w), three phase three wire(3p3w) or four phase four wire(3p4w) unbalanced. Line frequency measured from L1 voltage or L3 voltage.

Accuracy

- Voltage 0.5% of range maximum
- Current 0.5% of nominal
- Frequency 0.2% of mid-frequency
- Power factor 1% of unity (0.01)
- Active power (W) ±1% of range maximum
- Reactive power (VAR) ±1% of range maximum
- Apparent power (VA) ±1% of range maximum
- Active energy (Wh) Class 1 IEC 62053-21
- Reactive energy (VARh) ±1% of range maximum
- Total harmonic distortion 1% up to 31st harmonic
- Temperature co-efficient Voltage and current = 0.013%/°C typical
Active energy = 0.018%/°C, typical
- Response time to step input 1s, typical, to >99% of final reading, at 50 Hz.

Interfaces for External Monitoring

Three interfaces are provided:

- an RS485 communication channel that can be programmed for Modbus RTU protocol
- an Pulse output(Pulse 1) indicating real-time measured energy.(configurable)
- an Pulse output(Pulse 2) 400imp/kWh

The Modbus configuration (Baud rate etc.) and the pulse output assignments (kW/kVArh, import/export etc.) are configured through the Set-up screens.

Pulse Output

The unit provides two pulse outputs. Both pulse outputs are passive type.

Pulse output 1 is configurable. The pulse output can be set to generate pulses to represent total / import/export kWh or kVarh.

The pulse constant can be set to generate 1 pulse per:

dFt = 2.5 Wh/VArh

0.01 = 10 Wh/VArh

0.1 = 100 Wh/VArh

1 = 1 kWh/kVArh

10 = 10 kWh/kVArh

100 = 100 kWh/kVArh

Pulse width: 200/100/60ms

Pulse output 2 is non-configurable. It is fixed up with active kWh. The constant is 400imp/kWh.

RS485 Output for Modbus RTU

For Modbus RTU, the following RS485 communication parameters can be configured from the Set-up menu:

Baud rate 2400, 4800, 9600, 19200, 38400

Parity none (default)/odd/even

Stop bits 1 or 2

RS485 network address *nnn* – 3-digit number, 001 to 247

Modbus™ Word order Hi/Lo byte order is set automatically to normal or reverse. It cannot be configured from the set-up menu.

Reference Conditions of Influence Quantities

Influence Quantities are variables that affect measurement errors to a minor degree. Accuracy is verified under nominal value (within the specified tolerance) of these conditions.

- Ambient temperature 23°C ±1°C
- Input frequency 50 or 60Hz ±2%
- Input waveform Sinusoidal (distortion factor < 0.005)
- Magnetic field of external origin Terrestrial flux

Environment

- Operating temperature -25°C to +55°C*
- Storage temperature -40°C to +70°C*

- Relative humidity 0 to 90%, non-condensing
- Altitude Up to 2000m
- Warm up time 1 minute
- Vibration 10Hz to 50Hz, IEC 60068-2-6, 2g

Dimensions

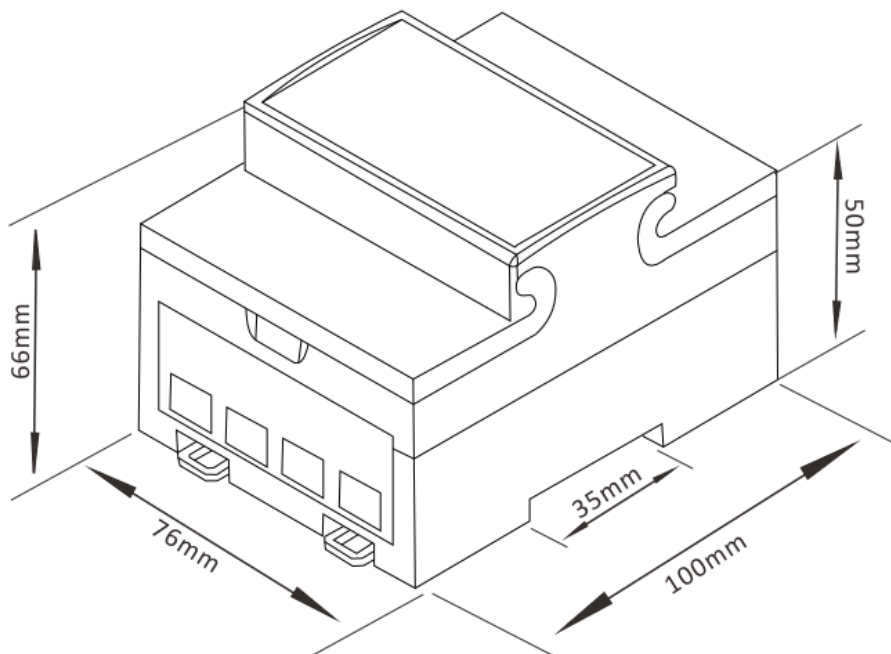

Wiring diagram

Three Phase Three Wires

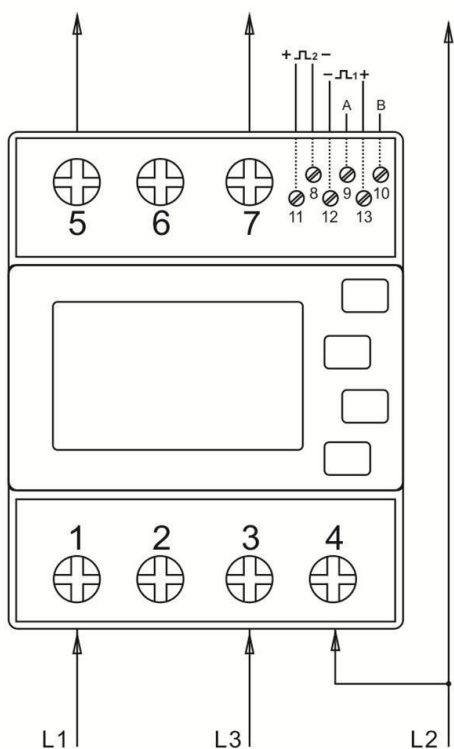

Three Phase Four Wires

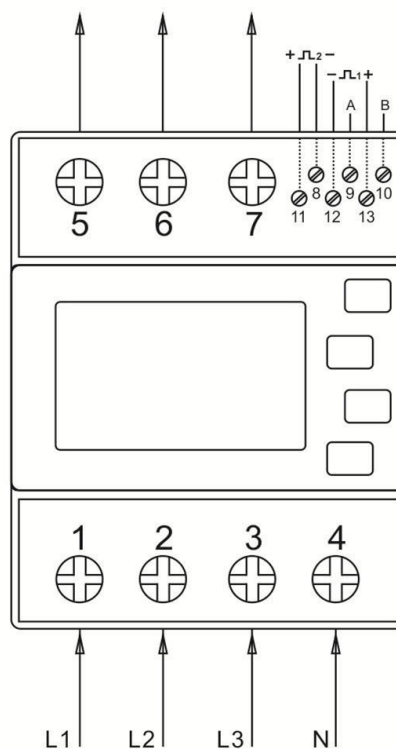

Single Phase Two Wires

