



User Manual

Smart Energy Controller SEC1000S

V1.1-2022-10-30

1 Symbols	01
------------------	----

2 Safety and Warning	01
-----------------------------	----

3 Mounting	
3.1 Mounting Instruction	02
3.2 Overview and Packaging	02
3.3 Inverter Installation	03

4 Troubleshooting	10
--------------------------	----

5 Technology parameter	10
-------------------------------	----

6 Relevant Certification	10
---------------------------------	----

1 Symbols



Caution! - Failure to observe a warning indicated in this manual may result in minor or moderate injury.



Components of the product can be recycled.



Danger of high voltage and electric shock!



This side up - The package must always be transported, handled and stored in such a way that the arrows always point upwards.



Product should not be disposed as normal household waste.



No more than six (6) identical packages be stacked on each other.



CE Mark



The package/product should be handled carefully and never be tipped over or slung.



Keep Dry – The package/product must be protected from excessive humidity and must accordingly be stored under cover.

2 Safety and Warning

SEC1000S of GoodWe Technologies Co., Ltd. (hereinafter referred to as GoodWe) has been designed and tested strictly according to the international safety regulation. As electrical and electric equipment, Safety Regulation shall be followed during installation and maintenance. Improper operation may bring severe damage to the operator, the third party and other properties.

- Installation, maintenance of SEC1000S must be performed by qualified personnel in compliance with local electrical standards, regulations and the requirements of local power authorities.
- To avoid electric shock, make sure the connection between SEC1000S and AC output of inverter, SEC1000S and Grid, is disconnected before performing any installation or maintenance.
- When in operation, users should not touch any of the electrical parts of SEC1000S, like internal components, cables, to avoid electric shock.
- All electrical installations must comply with local electrical standards and obtain permission from local power authorities before SEC1000S can be connected to the grid by professionals.
- Before replacing any internal components of SEC1000S, the connection between the inverter and SEC1000S, the power grid and SEC1000S must be disconnected, and the newly replaced components must meet the requirements of SEC1000S. Otherwise, GoodWe will not assume the responsibility and quality assurance for the personal harm.
- Make sure that the AC input voltage and input current match the rated voltage and current of SEC1000S, otherwise the components will be damaged or cannot work properly, and GoodWe will not assume the responsibility and quality assurance for this case.
- There are lightning protection modules inside. Make sure to connect the internal PE with the ground when installing SEC1000S.
- When in operation, do not plug or unplug cables of SEC1000S.
- SEC1000S must be installed out of reach of children.
- Appropriate antistatic measures should be taken.
- SEC1000S supports the three-phase four-wire grid structure only.
- Can only be used in spontaneous self-use mode.

3 Mounting

3.1 Mounting Instruction

- SEC1000S must be installed where there is no significant shaking, shock vibration and no direct rain or snow.
- SEC1000S shall be installed at eye level for easy operation and maintenance.
- SEC1000S should not be installed near inflammable and explosive items. Any strong electromagnetic equipment should be kept away from installation site.
- SEC1000S shall be installed at a location free from explosive hazardous media and free from gas and dust sufficient to corrode metals and destroy insulation.
- SEC1000S parameters and warning signs must be clearly visible after installation.
- SEC1000S should be installed without sunshine, rain and snow.

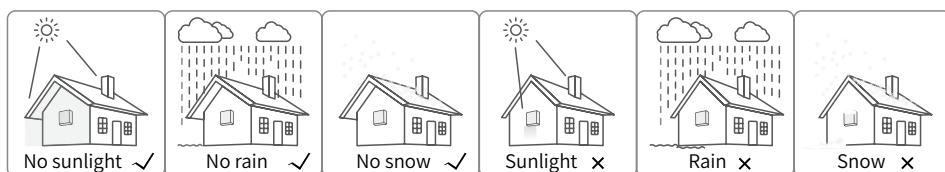

3.2 Overview and Packaging

After opening the package, confirm if it is consistent with specification of SEC1000S you purchased.

3.2.1 SEC1000S Overview

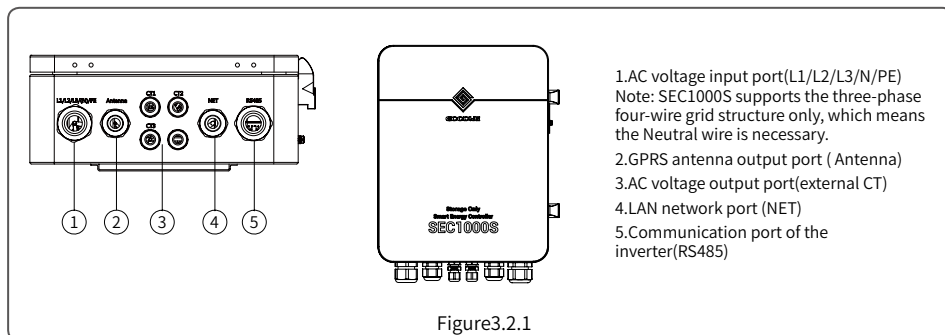
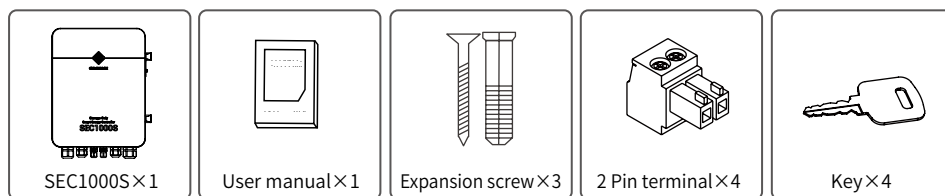
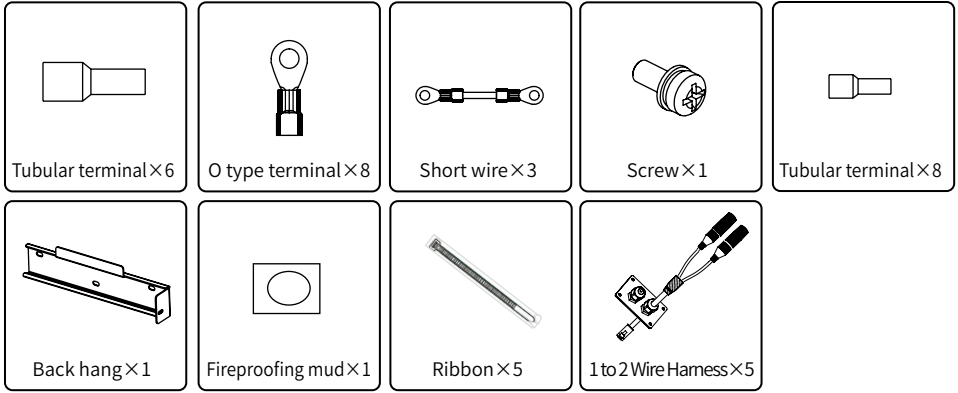

Figure3.2.1

3.2.2 Package





3.3 SEC1000S Installation

3.3.1 Selecting the installation location

The following must be considered when selecting the best location for an SEC1000S.

- The mount and installation method must be appropriate for the SEC1000S' s weight and dimensions.
- Install on a sturdy surface.
- The installation location must be well ventilated.
- SEC1000S can be placed horizontally or installed vertically.
- The SEC1000S must be installed vertical or with a backward tilt less 15°. No sideways tilt is allowed. The connection area must point downwards. Refer to Figure 3.3.1-1.

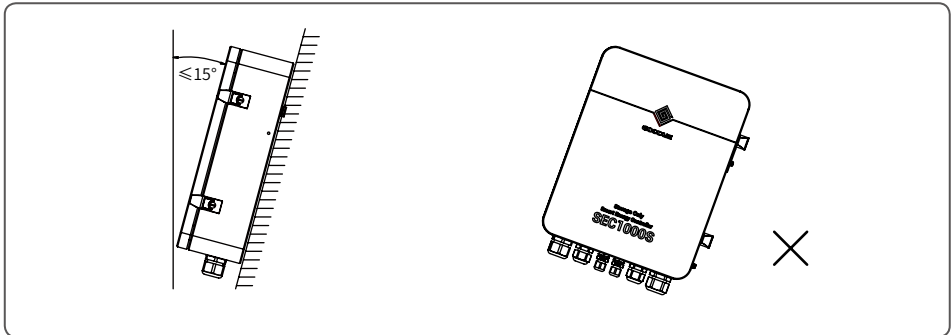

- To allow dissipation of heat, and for convenience of dismantling, clearances around the SEC1000S must be no less than the values, refer to figure 3.3.1-2.

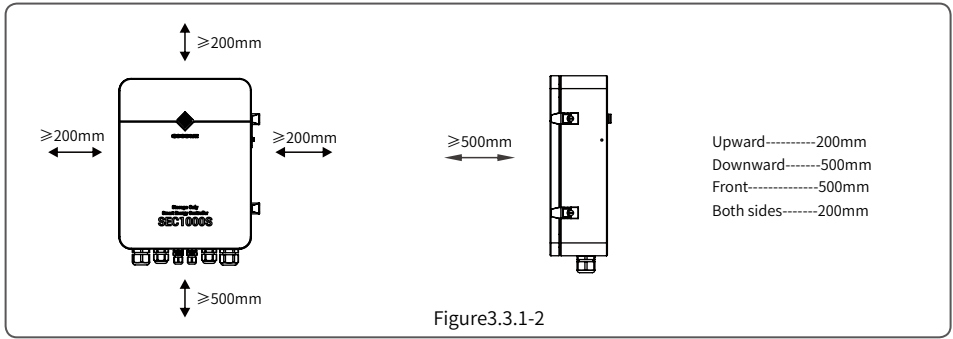

3.3.2 Mounting Procedure

(1) Drill holes on the wall, 8mm in diameter and 45mm deep; Refer to Figure 3.3.2-1.

(2) Fix the wall mounting bracket on the wall with expansion bolts in accessory bag, refer to Figure 3.3.2-2.

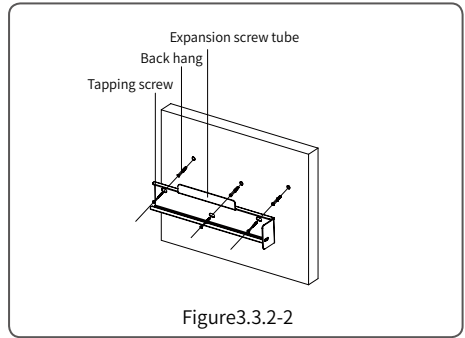
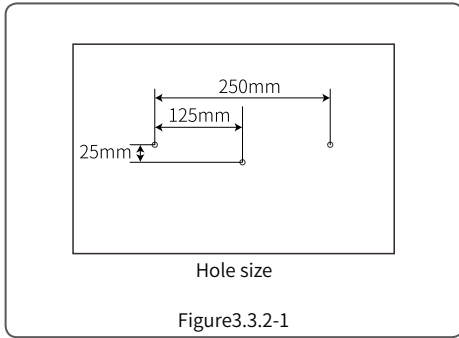

(3) Place SEC1000S on the wall-mounted bracket as illustrated in figure 3.3.2-3.

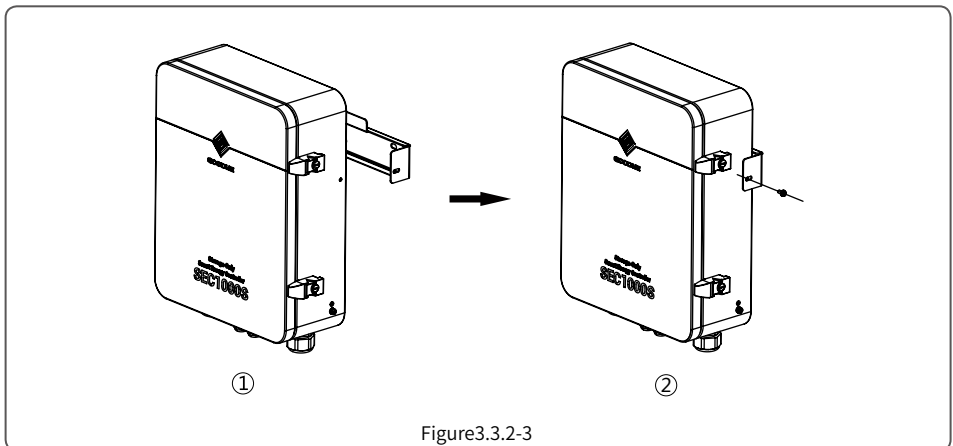

1. SEC1000S can be placed horizontally to work, as shown in the figure 3.3.2-4.
2. SEC1000S should be placed in a fixed place indoors as shown in the figure 3.3.2-5.

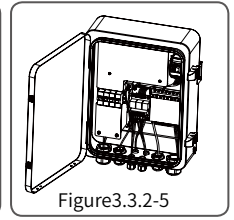
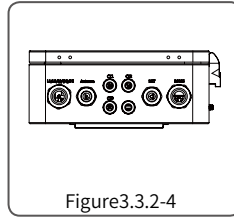

3.3.3 Port and wiring instructions

① Voltage Input Port(L1\L2\L3\N\PE)



Input phase voltage range: AC60V-AC280V;
 Input line voltage range: AC100V-AC480V;
 AC Frequency: 50/60Hz;

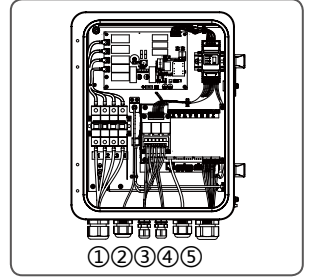

Multiple strands of soft copper wire

NO	Description	Content
A	Wire Diameter	No more than 25 mm
B	Cross Sectional Area of Copper Wire	R ecommend:AWG11-AWG13
C	Wire Length	About 45 mm
D	Length of Bare Copper Wire	About 12mm(10mm for PE)

Use wire crimper to press

③ Current Input Port (three sets of CT)

Connect three sets of external CT to the connector at the position shown in figure 3-1 (A+A-\B+B-\C+C-).
 For detailed external CT connection, please refer to the CT connection manual.

Recommended CT

According to the external current range, GoodWe recommends the following specifications, for reference only.

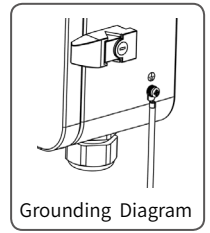

NO	Range of current tested	Content	Remark
1	$I_{max} < 250A$	CT 200A Acrel/AKH-0.66(200A/5A)	Backflow CT,closed type(Holesize31mm*11mm, 22mm)
		CT 250A/5A Acrel/AKH-0.66-K-30x20-250/5	Backflow CT,open type(Opening size:32mm*22mm),accuracy 0.5%
		CT 250A/5A Acrel/AKH-0.66-K-60x40-250/5	Backflow CT,open type(Opening size:62mm*42mm),accuracy 1.0%
2	$250A \leq I_{max} < 1000A$	CT 1000A/5A Acrel/AKH-0.66-K-60x40-1000/5	Backflow CT,open type(Opening size:62mm*42mm),accuracy 0.5%
		CT 1000A/5A Acrel/AKH-0.66-K-80x40-1000/5	Backflow CT,open type(Opening size:82mm*42mm),accuracy 0.5%
		CT 1000A/5A Acrel/AKH-0.66-K-80x80-1000/5	Backflow CT,open type(Opening size:82mm*82mm),accuracy 0.5%
3	$1000A \leq I_{max} < 5000A$	CT 5000A/5A Acrel/AKH-0.66-K-140x60-5000/5	Backflow CT,open type(Opening size:142mm*62mm),accuracy 0.2%
		CT 5000A/5A Acrel/AKH-0.66-K-160x80-5000/5	Backflow CT,open type(Opening size:162mm*82mm),accuracy 0.2%

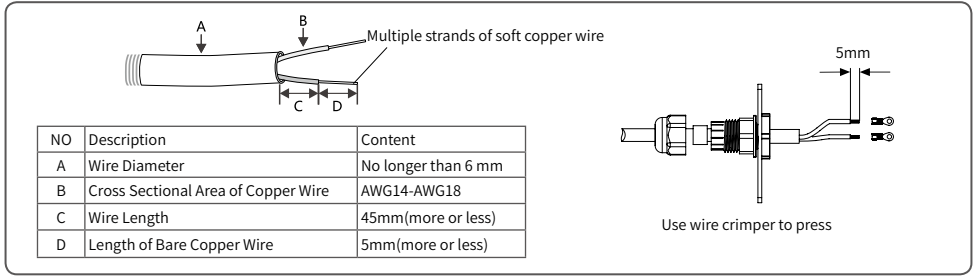

④ LAN Network port

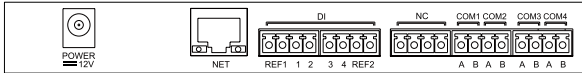

LAN SEC1000S uses this port when accessing a network cable;The access point is as shown in the "NET" position in the figure above.

It is recommended to use network cables better than Super Five Type. After wiring, use the fire-proof mud to seal the port, to ensure its protective performance.

⑤ Communication Port

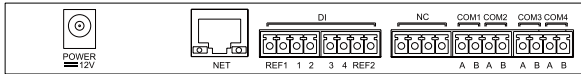

Descriptions of internal communication ports of SEC1000S are as following.

Port	Description
POWER	DC Power Input (Occupied)
NET	Ethernet Interface
DI	DRED or RCR functional interface
NC	reserve
COM1	485 interface1 with Inverter
COM2	485 interface2 with Inverter
COM3	485 interface3 with Inverter
COM4	485 interface4 with SEC1000S internal Meter(Occupied)

3.3.4 SEC1000S Grid Connection Diagram

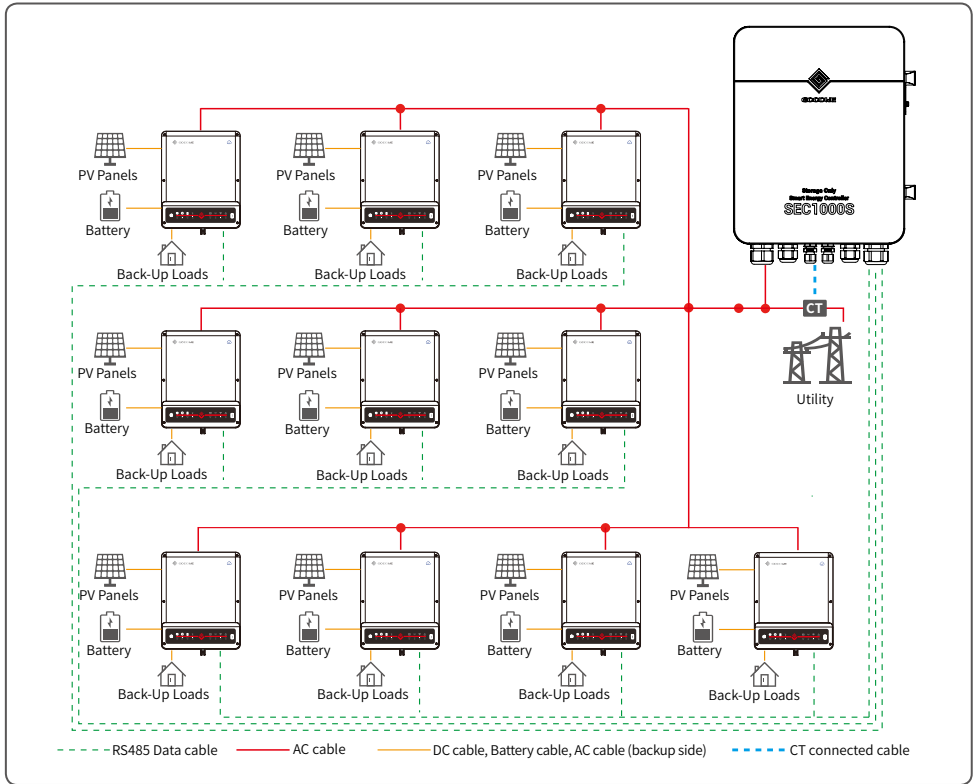

Note:

1. The system supports up to 10 inverters, please distribute them equally to each COM port.
2. No separate Smart Meter is required in inverter paralleling system along with SEC1000S deployed. This solution is only applicable to the paralleling of on-grid side not to back-up side. There are special requirements on the version of firmware of ET or BT applied in this solution, with DSP version 01 or newer and ARM version 09 or newer. The firmware version of SEC1000S designated for inverter paralleling application should be 01 or newer.

3.3.5 Main functions of SEC1000S

In the Grid Connection Diagram as shown in 3.3.4(quantity of Inverter can be more than one), SEC1000S will have the functions of Active Power Regulation, and Back flow prevention, etc. The corresponding parameters of the inverter are acquired and set through the software ProMate installed in computer for monitoring and configuring SEC1000S. ProMate is a kind of software that can configure Ezlogger Pro, SEC1000S etc. It can modify the network IP address of Ezlogger Pro and SEC1000S, configure the number of connected inverters, time setting, RCR, DRED function, configuration and on-site debugging. First, the user need to install "ProMate" in the computer by downloading ProMate from Internet (<https://en.goodwe.com/>), Please access to the website to download the program and competethe installation. If the user needs to use ProMate software to configure SEC1000S, it needs to be set in dynamic IP(DHCP) or static IP according to the network connection mode.

(1)If the user is in the dynamic IP mode, he/she only needs to connect the SEC1000S NET port to the Router LAN port with the network cable to connect to the network, namely plug and play.

(2)If the user has a static IP, it is necessary to switch SEC1000S to the static IP mode. That is, press the Reload key for about 10 seconds to reset and restart SEC1000S, About 10 seconds after pressing the Reload button, the LED lights on the SEC1000S internal EzLogger Pro Panel will blink from right to left and reset and restart.

After restart, SEC1000S will be switched to static IP mode(default IP:192.168.1.200), then use cables to connect SEC1000S“NET” port to the Ethernet port of the computer.At the same time, the IP address of the computer needs to be modified. The IP address and the default gateway should be set at 192.168.1.xxx segment ($1 \leq XXX \leq 250$ and $XXX \neq 200$). For example, the IP address can be set as 192.168.1.100 and the default gateway as 192.168.1.254.

The interface of Promate is as follows:

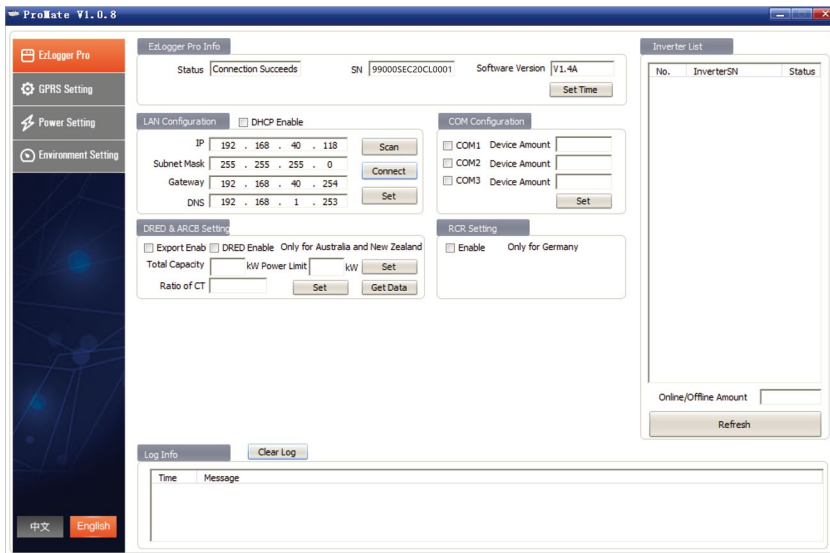

On “COM Configuration” part, you should enter the number of inverter connected to each communication port of SEC1000S. For example, you should enter “3” if there are 3 pieces of inverters communicate to COM1, enter “2” if there are 2 pieces of inverters communicate to COM2.

3.3.5.1 SEC1000S Anti Reverse Current Function

On “DRED & ARCB Setting” part, enter total capacity of the paralleling system and ratio of CT (external) and power limit into grid.

Note: the above steps are mandatory to set up the whole system.

Please check the option "Export Enable" if you want to apply export power limit function in your system. with this function enabled, you can monitor real-time data of grid connection such as output active power, output current, and output voltage.

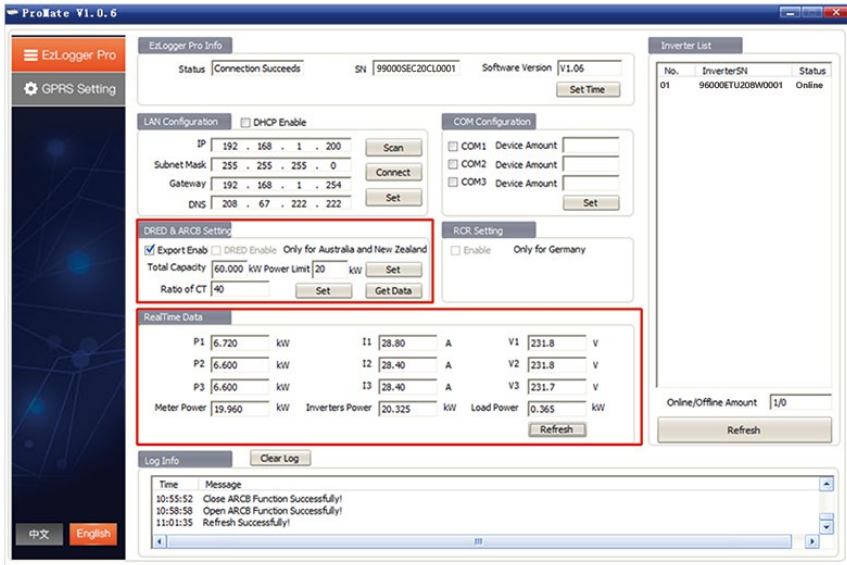

3.3.5.2 PV Master configuration for paralleling application (inverter)

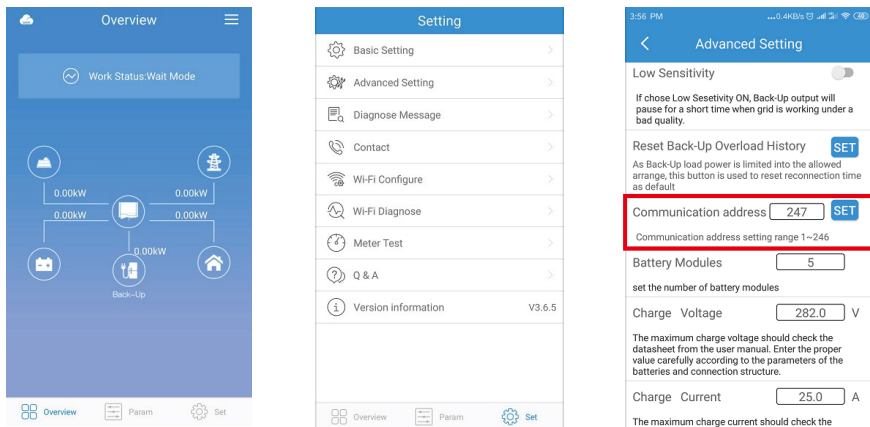

You should set communication address for every inverter in the paralleling system, and the address should be different from each other. For example, you may set the address for each inverter from 1 to 10 if there are 10 inverters in the paralleling system. The ID of inverter connected to the communication port should not be duplicate. To monitoring the whole system, all inverters should be registered under the same power plant on GoodWe monitoring platform SEMS Portal.

4 Troubleshooting

If the external CT current is connected in the wrong direction, please reconnect it. Take the reversed CT current connection of B+ and B- as an example to introduce the correcting method, as shown below:

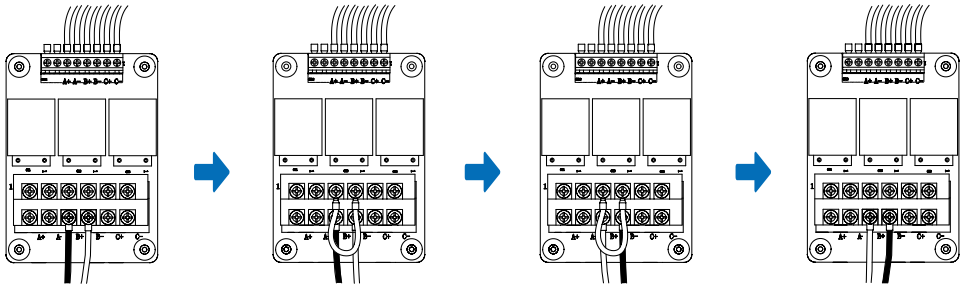

1. B+ and B- connected reversed

2. Add a cable between B+ and B- to short-circuit them

3. Correct connection of B+ and B-

4. Remove the short cable

Note: When replacing the meter, all 3 groups of CTs need to be short-circuited.

5 Technology parameter

Model	SEC1000S
Communication	
Max. Inverters Supported	20
RS485 interface	3
Ethernet	1*RJ45, 10/100 Mbps
Configuration	
Datalogger	Ezlogger*1
Meter	GM3000*1
Power Supply	100-280Vac, 50/60 Hz
Power Consumption (W)	≤10
Mechanical	
Dimensions (W×H×D mm)	350*460*143
Weight (kg)	6
Installation Method	Wall mounting, bracket mounting, pole mounting
Environment	
Operating Temperature Range (°C)	-25 ~ 60°C
Storage Temperature Range(°C)	-40 ~ 70°C
Relative Humidity	0-100% (non-condensing)
Max. Operating Altitude (m)	2000
Ingress Protection Rating	IP65

6 Relevant Certification







GoodWe Website

GoodWe Technologies Co., Ltd.

 No. 90 Zijin Rd., New District, Suzhou, 215011, China

 www.goodwe.com

 service@goodwe.com

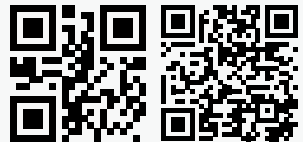

340-00711-00 Local Contacts