

Operating manual

# SUNNY BOY 3.0 / 3.6 / 4.0 / 5.0 / 6.0

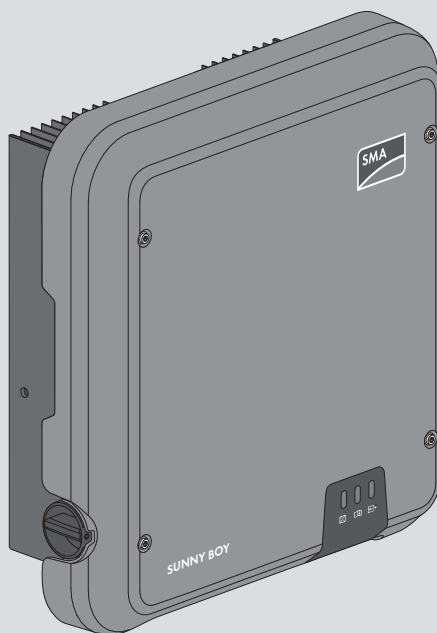

## Legal Provisions

The information contained in these documents is the property of SMA Solar Technology AG. No part of this document may be reproduced, stored in a retrieval system, or transmitted, in any form or by any means, be it electronic, mechanical, photographic, magnetic or otherwise, without the prior written permission of SMA Solar Technology AG. Internal reproduction used solely for the purpose of product evaluation or other proper use is allowed and does not require prior approval.

SMA Solar Technology AG makes no representations or warranties, express or implied, with respect to this documentation or any of the equipment and/or software it may describe, including (with no limitation) any implied warranties of utility, merchantability, or fitness for any particular purpose. All such representations or warranties are expressly disclaimed. Neither SMA Solar Technology AG nor its distributors or dealers shall be liable for any indirect, incidental, or consequential damages under any circumstances.

The exclusion of implied warranties may not apply in all cases under some statutes, and thus the above exclusion may not apply.

Specifications are subject to change without notice. Every attempt has been made to make this document complete, accurate and up-to-date. Readers are cautioned, however, that product improvements and field usage experience may cause SMA Solar Technology AG to make changes to these specifications without advance notice, or per contract provisions in those cases where a supply agreement requires advance notice. SMA Solar Technology AG shall not be responsible for any damages, including indirect, incidental or consequential damages, caused by reliance on the material presented, including, but not limited to, omissions, typographical errors, arithmetical errors or listing errors in the content material.

### SMA Warranty

You can download the current warranty conditions from the Internet at [www.SMA-Solar.com](http://www.SMA-Solar.com).

### Software licenses

The licenses for the used software modules can be called up on the user interface of the product.

### Trademarks

All trademarks are recognized, even if not explicitly identified as such. Missing designations do not mean that a product or brand is not a registered trademark.

### SMA Solar Technology AG

Sonnenallee 1

34266 Niestetal

Germany

Tel. +49 561 9522-0

Fax +49 561 9522-100

[www.SMA.de](http://www.SMA.de)

Email: [info@SMA.de](mailto:info@SMA.de)

Status: 12/5/2018

Copyright © 2018 SMA Solar Technology AG. All rights reserved.

# Table of Contents

<b>1</b>	<b>Information on this Document .....</b>	<b>6</b>
1.1	Validity .....	6
1.2	Target Group .....	6
1.3	Content and Structure of this Document .....	6
1.4	Levels of warning messages .....	6
1.5	Symbols in the Document .....	7
1.6	Typographies in the document .....	7
1.7	Designation in the document .....	7
<b>2</b>	<b>Safety .....</b>	<b>8</b>
2.1	Intended Use .....	8
2.2	IMPORTANT SAFETY INSTRUCTIONS.....	8
<b>3</b>	<b>Scope of Delivery .....</b>	<b>11</b>
<b>4</b>	<b>Product Overview .....</b>	<b>12</b>
4.1	Product Description .....	12
4.2	Symbols on the Product .....	13
4.3	Interfaces and Functions .....	14
4.4	LED Signals .....	16
<b>5</b>	<b>Mounting.....</b>	<b>18</b>
5.1	Requirements for Mounting .....	18
5.2	Mounting the Inverter.....	20
<b>6</b>	<b>Electrical Connection .....</b>	<b>22</b>
6.1	Overview of the Connection Area .....	22
6.2	AC Connection.....	22
6.2.1	Requirements for the AC Connection .....	22
6.2.2	Connecting the Inverter to the Utility Grid .....	24
6.2.3	Connecting Additional Grounding .....	25
6.3	Connecting the Network Cables.....	26
6.4	Connecting RS485 Devices.....	28
6.5	Mounting the WLAN Antenna .....	29
6.6	DC Connection.....	29
6.6.1	Requirements for the DC Connection .....	29
6.6.2	Assembling the DC Connectors.....	31
6.6.3	Connecting the PV Array.....	33
6.6.4	Disassembling the DC Connectors .....	35

<b>7</b>	<b>Commissioning .....</b>	<b>38</b>
7.1	Commissioning Procedure .....	38
7.2	Commissioning the Inverter.....	38
7.3	Selecting a configuration option .....	40
7.4	Starting the Self-Test (for Italy and Dubai).....	42
<b>8</b>	<b>Operation .....</b>	<b>44</b>
8.1	Establishing a connection to the user interface .....	44
8.1.1	Establishing a Direct Connection via Ethernet .....	44
8.1.2	Establishing a direct connection via WLAN .....	44
8.1.3	Establishing a Connection via Ethernet in the local network .....	46
8.1.4	Establishing a Connection via WLAN in the Local Network .....	47
8.2	Logging In and Out of the User Interface.....	48
8.3	Start Page Design of the User Interface.....	49
8.4	Activating the Smart Inverter Screen.....	51
8.5	Starting the Installation Assistant.....	52
8.6	Activate WPS Function.....	53
8.7	Switching WLAN On and Off.....	53
8.8	Switching the Dynamic Power Display Off.....	54
8.9	Changing the Password.....	55
8.10	Changing Operating Parameters.....	55
8.11	Configuring the Country Data Set.....	56
8.12	Configuring Feed-In Management.....	56
8.13	Configuring the Modbus Function.....	58
8.14	Activating the Receipt of Control Signals (Only for Italy).....	58
8.15	Deactivating Grounding Conductor Monitoring.....	59
8.16	Saving the Configuration in a File.....	59
8.17	Adopting a Configuration from a File.....	59
8.18	Updating the Firmware .....	60
<b>9</b>	<b>Disconnecting the Inverter from Voltage Sources .....</b>	<b>61</b>
<b>10</b>	<b>Cleaning the Inverter .....</b>	<b>63</b>
<b>11</b>	<b>Troubleshooting.....</b>	<b>64</b>
11.1	Forgotten Password.....	64
11.2	Event Messages .....	65
11.3	Checking the PV System for Ground Faults .....	81
<b>12</b>	<b>Decommissioning the Inverter.....</b>	<b>85</b>
<b>13</b>	<b>Technical Data .....</b>	<b>88</b>

13.1	DC/AC .....	88
13.1.1	Sunny Boy 3.0 / 3.6 / 4.0.....	88
13.1.2	Sunny Boy 5.0 / 6.0.....	90
13.2	Climatic Conditions .....	92
13.3	Protective Devices .....	92
13.4	Equipment .....	93
13.5	Torques .....	93
13.6	Data Storage Capacity.....	93
<b>14</b>	<b>Contact .....</b>	<b>94</b>
<b>15</b>	<b>EU Declaration of Conformity .....</b>	<b>96</b>

# 1 Information on this Document

## 1.1 Validity

This document is valid for:

- SB3.0-1AV-41 (Sunny Boy 3.0)
- SB3.6-1AV-41 (Sunny Boy 3.6)
- SB4.0-1AV-41 (Sunny Boy 4.0)
- SB5.0-1AV-41 (Sunny Boy 5.0)
- SB6.0-1AV-41 (Sunny Boy 6.0)

## 1.2 Target Group

This document is intended for qualified persons and end users. Only qualified persons are allowed to perform the activities marked in this document with a warning symbol and the caption "Qualified person". Tasks that do not require any particular qualification are not marked and can also be performed by end users. Qualified persons must have the following skills:

- Knowledge of how an inverter works and is operated
- Training in how to deal with the dangers and risks associated with installing, repairing and using electrical devices and installations
- Training in the installation and commissioning of electrical devices and installations
- Knowledge of all applicable laws, standards and directives
- Knowledge of and compliance with this document and all safety information

## 1.3 Content and Structure of this Document

This document describes the mounting, installation, commissioning, configuration, operation, troubleshooting and decommissioning of the product as well as the operation of the product user interface.

You will find the latest version of this document and further information on the product in PDF format and as eManual at [www.SMA-Solar.com](http://www.SMA-Solar.com). You can also call up the eManual via the user interface of the product.

Illustrations in this document are reduced to the essential information and may deviate from the real product.

## 1.4 Levels of warning messages

The following levels of warning messages may occur when handling the product.

### DANGER

Indicates a hazardous situation which, if not avoided, will result in death or serious injury.

### WARNING

Indicates a hazardous situation which, if not avoided, could result in death or serious injury.



## ⚠ CAUTION

Indicates a hazardous situation which, if not avoided, could result in minor or moderate injury.

## NOTICE

Indicates a situation which, if not avoided, can result in property damage.

## 1.5 Symbols in the Document

Symbol	Explanation
	Information that is important for a specific topic or goal, but is not safety-relevant
<input type="checkbox"/>	Indicates a requirement for meeting a specific goal
<input checked="" type="checkbox"/>	Desired result
<b>x</b>	A problem that might occur
	Example
<b>▲ QUALIFIED PERSON</b>	Sections describing activities to be performed by qualified persons only

## 1.6 Typographies in the document

Typography	Use	Example
<b>bold</b>	<ul style="list-style-type: none"> <li>Messages</li> <li>Terminals</li> <li>Elements on a user interface</li> <li>Elements to be selected</li> <li>Elements to be entered</li> </ul>	<ul style="list-style-type: none"> <li>Connect the insulated conductors to the terminals <b>X703:1</b> to <b>X703:6</b>.</li> <li>Enter <b>10</b> in the field <b>Minutes</b>.</li> </ul>
>	<ul style="list-style-type: none"> <li>Connects several elements to be selected</li> </ul>	<ul style="list-style-type: none"> <li>Select <b>Settings &gt; Date</b>.</li> </ul>
[Button] [Key]	<ul style="list-style-type: none"> <li>Button or key to be selected or pressed</li> </ul>	<ul style="list-style-type: none"> <li>Select <b>[Enter]</b>.</li> </ul>

## 1.7 Designation in the document

Complete designation	Designation in this document
Sunny Boy	Inverter, product

## 2 Safety

### 2.1 Intended Use

The Sunny Boy is a transformerless PV inverter with two MPP trackers which converts the direct current of the PV array to grid-compliant alternating current and feeds it into the utility grid.

The product is suitable for indoor and outdoor use.

The product must only be operated with PV modules of protection class II in accordance with IEC 61730, application class A. The PV modules must be compatible with this product.

The product is not equipped with a transformer and therefore has no galvanic isolation. The product must not be operated with PV modules whose outputs are grounded. This can cause the product to be destroyed. The product may be operated with PV modules whose frame is grounded.

PV modules with a high capacity to ground must only be used if their coupling capacity does not exceed 1.4  $\mu\text{F}$  (for information on how to calculate the coupling capacity, see the Technical Information "Leading Leakage Currents" at [www.SMA-Solar.com](http://www.SMA-Solar.com)).

All components must remain within their permitted operating ranges and their installation requirements at all times.

The product must only be used in countries for which it is approved or released by SMA Solar Technology AG and the grid operator.

Use this product only in accordance with the information provided in the enclosed documentation and with the locally applicable laws, regulations, standards and directives. Any other application may cause personal injury or property damage.

Alterations to the product, e.g. changes or modifications, are only permitted with the express written permission of SMA Solar Technology AG. Unauthorized alterations will void guarantee and warranty claims and in most cases terminate the operating license. SMA Solar Technology AG shall not be held liable for any damage caused by such changes.

Any use of the product other than that described in the Intended Use section does not qualify as the intended use.

The enclosed documentation is an integral part of this product. Keep the documentation in a convenient, dry place for future reference and observe all instructions contained therein.

This document does not replace and is not intended to replace any local, state, provincial, federal or national laws, regulations or codes applicable to the installation, electrical safety and use of the product. SMA Solar Technology AG assumes no responsibility for the compliance or non-compliance with such laws or codes in connection with the installation of the product.

The type label must remain permanently attached to the product.

### 2.2 IMPORTANT SAFETY INSTRUCTIONS

#### SAVE THESE INSTRUCTIONS

This section contains safety information that must be observed at all times when working on or with the product.



The product has been designed and tested in accordance with international safety requirements. As with all electrical or electronic devices, there are residual risks despite careful construction. To prevent personal injury and property damage and to ensure long-term operation of the product, read this section carefully and observe all safety information at all times.

### DANGER

#### **Danger to life due to electric shock when live components or DC cables are touched**

When exposed to sunlight, the PV modules generate high DC voltage which is present in the DC cables. Touching live DC cables results in death or lethal injuries due to electric shock.

- Disconnect the product from voltage sources and make sure it cannot be reconnected before working on the device.
- Do not touch non-insulated parts or cables.
- Wear suitable personal protective equipment for all work on the product.

### DANGER

#### **Danger to life due to electric shock from touching an ungrounded PV module or array frame**

Touching ungrounded PV modules or array frames results in death or lethal injuries due to electric shock.

- Connect and ground the frame of the PV modules, the array frame and the electrically conductive surfaces so that there is continuous conduction. Observe the applicable local regulations.

### DANGER

#### **Danger to life due to electric shock when touching live system components in case of a ground fault**

If a ground fault occurs, parts of the system may still be live. Touching live parts and cables results in death or lethal injuries due to electric shock.

- Disconnect the product from voltage sources and make sure it cannot be reconnected before working on the device.
- Touch the cables of the PV array on the insulation only.
- Do not touch any parts of the substructure or frame of the PV array.
- Do not connect PV strings with ground faults to the inverter.

### CAUTION

#### **Risk of burns due to hot enclosure parts**

Some parts of the enclosure can get hot during operation.

- During operation, do not touch any parts other than the enclosure lid of the inverter.

**⚠ CAUTION****Risk of injury due to weight of product**

Injuries may result if the product is lifted incorrectly or dropped while being transported or when attaching it to or removing it from the wall mounting bracket.

- Transport and lift the product carefully. Take the weight of the product into account.
- Wear suitable personal protective equipment for all work on the product.

**NOTICE****Damage due to cleaning agents**

The use of cleaning agents may cause damage to the product and its components.

- Clean the product and all its components only with a cloth moistened with clear water.

### 3 Scope of Delivery

Check the scope of delivery for completeness and any externally visible damage. Contact your distributor if the scope of delivery is incomplete or damaged.

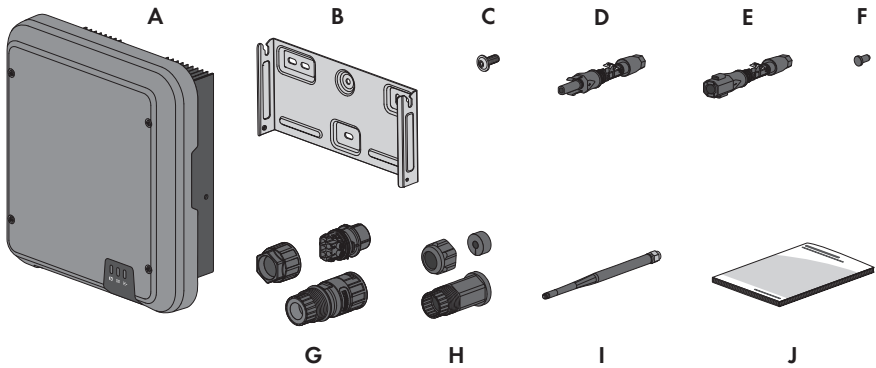

Figure 1: Components included in the scope of delivery

Position	Quantity	Designation
A	1	Inverter
B	1	Wall mounting bracket
C	3	Pan head screw M5x12
D	4	Positive DC connector
E	4	Negative DC connector
F	8	Sealing plug
G	1	AC connector
H	1	RJ45 protective sleeve: swivel nut, cable support sleeve, threaded sleeve
I	1	WLAN antenna
J	1	Quick reference guide with password label on the rear side The label contains the following information: <ul style="list-style-type: none"> <li>• PIC (Product Identification Code) identification key for registering the system in Sunny Portal</li> <li>• RID (Registration Identifier) registration ID for registering the system in Sunny Portal</li> <li>• WLAN password WPA2-PSK (WiFi Protected Access 2 - Preshared Key) for direct connection to the inverter via WLAN</li> </ul>

## 4 Product Overview

### 4.1 Product Description

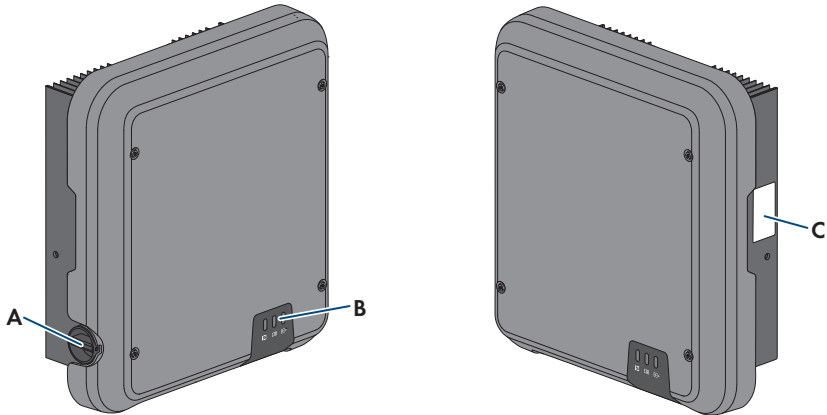



















Figure 2: Design of the Product

Position	Designation
A	DC load-break switch
B	LEDs The LEDs indicate the operating state of the inverter.
C	Type label The type label clearly identifies the product. The type label must remain permanently attached to the product. You will find the following information on the type label: <ul style="list-style-type: none"> <li>• Device type (Model)</li> <li>• Serial number (Serial No. or S/N)</li> <li>• Date of manufacture</li> <li>• Identification key (PIC) for registration in Sunny Portal</li> <li>• Registration ID (RID) for registration in Sunny Portal</li> <li>• WLAN password (WPA2-PSK) for the direct connection to the user interface of the inverter via WLAN</li> <li>• Device-specific characteristics</li> </ul>

## 4.2 Symbols on the Product

Symbol	Explanation
	Beware of a danger zone This symbol indicates that the product must be additionally grounded if additional grounding or equipotential bonding is required at the installation site.
	Beware of electrical voltage The product operates at high voltages.
	Beware of hot surface The product can get hot during operation.
	Danger to life due to high voltages in the inverter; observe a waiting time of 5 minutes High voltages that can cause lethal electric shocks are present in the live components of the inverter. Prior to performing any work on the inverter, disconnect it from all voltage sources as described in this document.
	Observe the documentation Observe all documentation supplied with the product.
	Observe the documentation Together with the red LED, this symbol indicates an error.
	Inverter Together with the green LED, this symbol indicates the operating state of the inverter.
	Data transmission Together with the blue LED, this symbol indicates the status of the network connection.
	Grounding conductor This symbol indicates the position for connecting a grounding conductor.
	Alternating current
	Direct current

Symbol	Explanation
	The product is has no galvanic isolation.
	WEEE designation Do not dispose of the product together with the household waste but in accordance with the disposal regulations for electronic waste applicable at the installation site.
	The product is suitable for outdoor installation.
<b>IP65</b>	Degree of protection IP65 The product is protected against the penetration of dust and water that is directed as a jet against the enclosure from all directions.
	CE marking The product complies with the requirements of the applicable EU directives.
	RCM (Regulatory Compliance Mark) The product complies with the requirements of the applicable Australian standards.
	ICASA The product complies with the requirements of the South African standards for telecommunication.
	ANATEL The product complies with the requirements of the Brazilian standards for telecommunication.  Este equipamento opera em caráter secundário, isto é, não tem direito a proteção contra interferência prejudicial, mesmo de estações do mesmo tipo, e não pode causar interferência a sistemas operando em caráter primário.

### 4.3 Interfaces and Functions

The inverter is equipped with the following interfaces and functions:

#### User interface for monitoring and configuration

The product is equipped as standard with an integrated webserver, which provides a user interface for configuring and monitoring the product. The product user interface can be called up via the web browser if there is an existing connection to an end device (e.g. computer, tablet PC or smartphone).

## Smart Inverter Screen

The Smart Inverter Screen enables you to view the status display and to display the current power and consumption on the user interface login page. You therefore have an overview of the most important inverter data without having to log into the user interface.

The Smart Inverter Screen is deactivated by default. The Smart Inverter Screen can be activated via the user interface once the inverter has been commissioned.

## SMA Speedwire

The product is equipped with SMA Speedwire as standard. SMA Speedwire is a type of communication based on the Ethernet standard. SMA Speedwire is designed for a data transfer rate of 100 Mbps and enables optimum communication between Speedwire devices within systems.

## SMA Webconnect

The inverter is equipped with a Webconnect function as standard. The Webconnect function enables direct data transmission between the inverters and Internet portals Sunny Portal and Sunny Places without any additional communication device and for a maximum of 4 inverters per visualized system. In PV systems with more than 4 inverters, there is the option of establishing data transmission between the inverters and Sunny Portal via the data logger (e.g., SMA Data Manager) or distributing the inverters over several systems. If there is an existing WLAN or Ethernet connection, you can directly access your visualized system via the web browser on your end device.

Webconnect enables - for PV systems operated in Italy - the connection or disconnection of the inverter to or from the utility grid and the specifying of the frequency limits to be used via IEC61850-GOOSE messages.

## WLAN

The product is equipped with a WLAN interface as standard. The inverter is delivered with the WLAN interface activated as standard. If you do not want to use WLAN, you can deactivate the WLAN interface.

In addition, the product has a WPS function. The WPS function is for automatically connecting the product to a network (e.g. via router) and establish a direct connection between the product and an end device.

## Modbus

The product is equipped with a Modbus interface. The Modbus interface is deactivated by default and must be configured as needed.

The Modbus interface of the supported SMA products is designed for industrial use – via SCADA systems, for example – and has the following tasks:

- Remote query of measured values
- Remote setting of operating parameters
- Setpoint specifications for system control

## Grid management services

The product is equipped with service functions for grid management.

Depending on the requirements of the grid operator, you can activate and configure the functions (e.g. active power limitation) via operating parameters.

### Parallel Operation of the DC Inputs A and B

You have the option of operating the inverter DC inputs A and B in parallel. As a result, and as opposed to normal operation, several parallel-connected strings can be connected to the inverter. The inverter automatically detects the parallel operation of the DC inputs A and B.

### SMA OptiTrac Global Peak

SMA OptiTrac Global Peak is an advancement of SMA OptiTrac and allows the operating point of the inverter to follow the optimal operating point of the PV array (MPP) precisely at all times. In addition, with the aid of SMA OptiTrac Global Peak, the inverter detects several maximum power points in the available operating range, such as may occur particularly with partially shaded strings. SMA OptiTrac Global Peak is enabled by default.

### All-pole sensitive residual-current monitoring unit

The all-pole sensitive residual-current monitoring unit detects alternating and direct differential currents. In single-phase and three-phase inverters, the integrated differential current sensor detects the current difference between the neutral conductor and the line conductor(s). If the current difference increases suddenly, the inverter disconnects from the utility grid.

### SMA Smart Connected

SMA Smart Connected is the free monitoring of the inverter via the SMA Sunny Portal. Thanks to SMA Smart Connected, the PV system operator and qualified person will be informed automatically and proactively about inverter events that occur.

SMA Smart Connected is activated during registration in Sunny Portal. In order to use SMA Smart Connected, it is necessary that the inverter is permanently connected to Sunny Portal and the data of the PV system operator and qualified person is stored in Sunny Portal and up-to-date.

## 4.4 LED Signals

The LEDs indicate the operating state of the inverter.

LED signal	Explanation
The green LED is flashing (two seconds on and two seconds off)	Waiting for feed-in conditions The conditions for feed-in operation are not yet met. As soon as the conditions are met, the inverter will start feed-in operation.
The green LED flashes quickly	Update of central processing unit The central processing unit of the inverter is being updated.
The green LED is glowing	Feed-in operation The inverter feeds in with a power of at least 90%.



LED signal	Explanation
The green LED is pulsing	<p>Feed-in operation</p> <p>The inverter is equipped with a dynamic power display via the green LED. Depending on the power, the green LED pulses fast or slow. If necessary, you can switch off the dynamic power display via the green LED.</p>
The green LED is off	The inverter is not feeding into the utility grid.
The red LED is glowing	<p>Event occurred</p> <p>If an event occurs, a distinct event message and the corresponding event number will be displayed in addition on the inverter user interface or in the communication product.</p>
The blue LED flashes slowly for approx. one minute	<p>Communication connection is being established</p> <p>The inverter is establishing a connection to a local network or is establishing a direct connection to an end device via Ethernet (e.g. computer, tablet PC or smartphone).</p>
The blue LED flashes quickly for approx. two minutes.	<p>WPS active</p> <p>The WPS function is active.</p>
The blue LED is glowing	<p>Communication active</p> <p>There is an active connection with a local network or there is a direct connection with an end device via Ethernet (e.g. computer, tablet PC or smartphone).</p>

## 5 Mounting

### 5.1 Requirements for Mounting

#### Requirements for the Mounting Location:

#### **⚠ WARNING**

#### **Danger to life due to fire or explosion**

Despite careful construction, electrical devices can cause fires.

- Do not mount the product in areas containing highly flammable materials or gases.
  - Do not mount the product in potentially explosive atmospheres.
- A solid support surface must be available (e.g., concrete or masonry). When mounted on drywall or similar materials, the product emits audible vibrations during operation which could be perceived as annoying.
  - The mounting location must be inaccessible to children.
  - The mounting location must be suitable for the weight and dimensions of the product (see Section 13 "Technical Data", page 88).
  - The mounting location must not be exposed to direct solar irradiation. If the product is exposed to direct solar irradiation, the exterior plastic parts might age prematurely and overheating might occur. When becoming too hot, the product reduces its power output to avoid overheating.
  - The mounting location should be freely and safely accessible at all times without the need for any auxiliary equipment (such as scaffolding or lifting platforms). Non-fulfillment of these criteria may restrict servicing.
  - The DC load-break switch of the product must always be freely accessible.
  - All ambient conditions must be met (see Section 13, page 88).
  - To ensure optimum operation, the ambient temperature should be between  $-25^{\circ}\text{C}$  and  $+40^{\circ}\text{C}$ .

#### Permitted and prohibited mounting positions:

- The product may only be mounted in a permitted position. This will ensure that no moisture can penetrate the product.
- The product should be mounted such that the LED signals can be read off without difficulty.

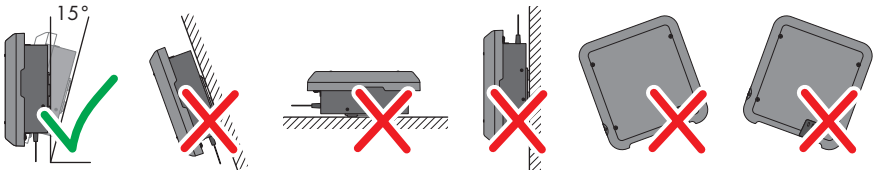

Figure 3: Permitted and prohibited mounting positions

**Dimensions for mounting:**

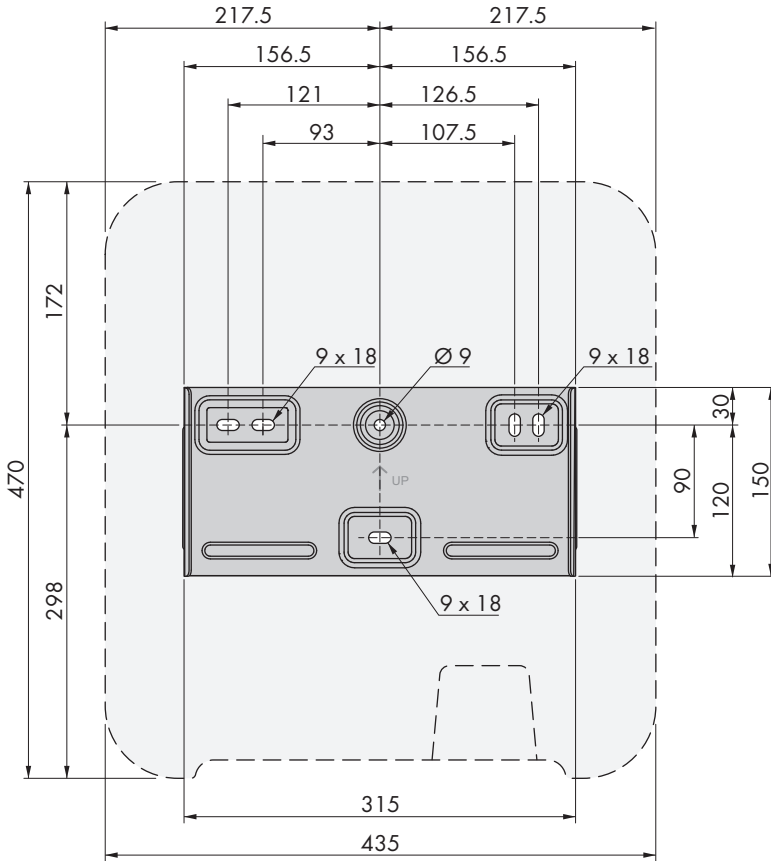

Figure 4: Position of the anchoring points(Dimensions in mm)

**Recommended Clearances:**

If you maintain the recommended clearances, adequate heat dissipation will be ensured. Thus, you will prevent power reduction due to excessive temperature.

- Maintain the recommended clearances to walls as well as to other inverters or objects.
- If multiple inverters are mounted in areas with high ambient temperatures, increase the clearances between the inverters and ensure sufficient fresh-air supply.

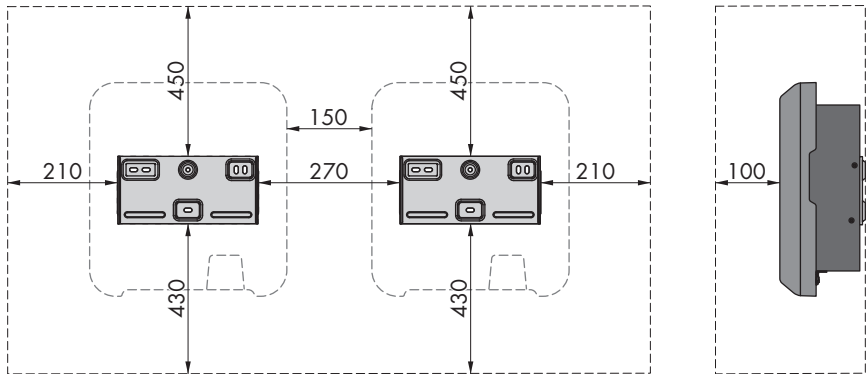

Figure 5: Recommended clearances (Dimensions in mm)

## 5.2 Mounting the Inverter

### ⚠ QUALIFIED PERSON

**Additionally required mounting material (not included in the scope of delivery):**

- 3 screws, suitable for the support surface and the weight of the inverter (diameter: minimum 6 mm)
- 3 washers, suitable for the screws (outer diameter: minimum 18 mm)
- Where necessary, 3 screw anchors suitable for the support surface and the screws

### ⚠ CAUTION

#### Risk of injury due to weight of product

Injuries may result if the product is lifted incorrectly or dropped while being transported or when attaching it to or removing it from the wall mounting bracket.

- Transport and lift the product carefully. Take the weight of the product into account.
- Wear suitable personal protective equipment for all work on the product.

**Procedure:**

1.

### ⚠ CAUTION

#### Risk of injury due to damaged cables

There may be power cables or other supply lines (e.g. gas or water) routed in the wall.

- Ensure that no lines are laid in the wall which could be damaged when drilling holes.

- Align the wall mounting bracket horizontally on the wall and mark the position of the drill holes. Use at least one hole on the right- and left-hand side and the lower hole in the middle of the wall mounting bracket. Tip: When mounting on a post, use the upper and lower central holes of the wall mounting bracket.

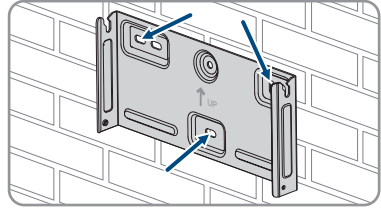

- Set the wall mounting bracket aside and drill the marked holes.
- Insert screw anchors into the drill holes if the support surface requires them.
- Secure the wall mounting bracket horizontally using screws and washers.

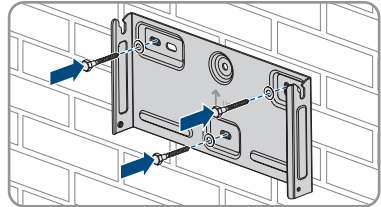

- Hook the inverter into the wall mounting bracket. When doing so, the two right- and left-hand keys on the ribs on the rear side of the inverter must be hooked into the respective right-hand and left-hand keyways in the wall mounting bracket.

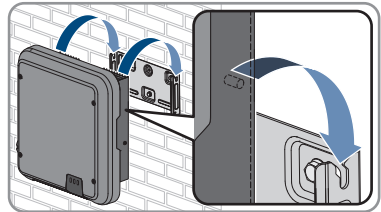

- Ensure that the inverter is securely in place.
- Secure the inverter to the wall mounting bracket. To do so, insert one pan head screw M5x12 each into the lower screw hole on both sides of the inverter anchorage bracket respectively and tighten them using a Torx screwdriver (TX 25, torque: 2.5 Nm).

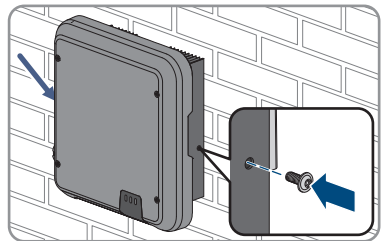

## 6 Electrical Connection

### 6.1 Overview of the Connection Area

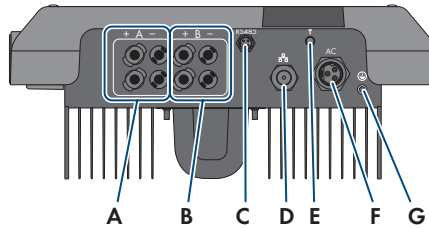

Figure 6: Connection areas at the bottom of the inverter

Position	Designation
A	2 positive and 2 negative DC connectors, input A
B	2 positive and 2 negative DC connectors, input B
C	Jack with protective cap for RS485 communication connection
D	Network port with protective cap
E	Jack with protective cap for the WLAN antenna
F	Jack for the AC connection
G	Connection point for an additional grounding

## 6.2 AC Connection

### 6.2.1 Requirements for the AC Connection

#### Cable requirements:

- External diameter: 10 mm to 14 mm
- Conductor cross-section: 2.5 mm<sup>2</sup> to 6 mm<sup>2</sup>
- Insulation stripping length: 12 mm
- Sheath stripping length: 50 mm
- The cable must be dimensioned in accordance with the local and national directives for the dimensioning of cables. The requirements for the minimum wire size derive from these directives. Examples of factors influencing cable dimensioning are: nominal AC current, type of cable, routing method, cable bundling, ambient temperature and maximum desired line losses (for calculation of line losses, see the design software "Sunny Design" from software version 2.0 at [www.SMA-Solar.com](http://www.SMA-Solar.com)).

**Load-break switch and cable protection:****NOTICE****Damage to the inverter due to the use of screw-type fuses as load-break switches**

Screw-type fuses (e.g. DIAZED fuse or NEOZED fuse) are not load-break switches.

- Do not use screw-type fuses as load-break switches.
  - Use a load-break switch or circuit breaker as a load disconnection unit (for information and design examples, see the Technical Information "Circuit Breaker" at [www.SMA-Solar.com](http://www.SMA-Solar.com)).
- In PV systems with multiple inverters, protect each inverter with a separate circuit breaker. Make sure to observe the maximum permissible fuse protection (see Section 13 "Technical Data", page 88). This will prevent residual voltage from being present at the corresponding cable after disconnection.
- Loads installed between the inverter and the circuit breaker must be fused separately.

**Residual-current monitoring unit:**

- If an external residual-current device is required, install a residual-current device which trips at a residual current of 100 mA or higher (for details on selecting a residual-current device, see the Technical Information "Criteria for Selecting a Residual-Current Device" at [www.SMA-Solar.com](http://www.SMA-Solar.com)).

**Overvoltage category:**

The inverter can be used in grids of overvoltage category III or lower in accordance with IEC 60664-1. That means that the inverter can be permanently connected to the grid-connection point of a building. In case of installations with long outdoor cabling routes, additional measures to reduce overvoltage category IV to overvoltage category III are required (see the Technical Information "Overvoltage Protection" at [www.SMA-Solar.com](http://www.SMA-Solar.com)).

**Grounding conductor monitoring:**

The inverter is equipped with a grounding conductor monitoring device. This grounding conductor monitoring device detects when there is no grounding conductor connected and disconnects the inverter from the utility grid if this is the case. Depending on the installation site and grid configuration, it may be advisable to deactivate the grounding conductor monitoring. This is necessary, for example, in an IT system if there is no neutral conductor present and you intend to install the inverter between two line conductors. If you are uncertain about this, contact your grid operator or SMA Solar Technology AG.

- Grounding conductor monitoring must be deactivated after initial start-up depending on the grid configuration (see Section 8.15, page 59).

### **i** Safety in accordance with IEC 62109 when the grounding conductor monitoring is deactivated

In order to guarantee safety in accordance with IEC 62109 when the grounding conductor monitoring is deactivated, you have to connect an additional grounding conductor to the inverter.

- Connect an additional grounding conductor that has a cross-section of at least 10 mm (see Section 6.2.3, page 25). This prevents touch current in the event of the grounding conductor on the AC connector bush insert failing.

### **i** Connection of an additional grounding conductor

In some countries, an additional grounding conductor is generally required. In each case, observe the locally applicable regulations.

- If an additional grounding conductor is required, connect the one that has a cross-section of at least 10 mm (see Section 6.2.3, page 25). This prevents touch current in the event of the grounding conductor on the AC connector bush insert failing.

## 6.2.2 Connecting the Inverter to the Utility Grid

### **⚠ QUALIFIED PERSON**

#### Requirements:

- The AC and DC electric circuits are isolated from the enclosure. If required by the *National Electrical Code*® ANSI/NFPA 70 or *Canadian Electrical Code*® CSA C22.1, the installer is responsible for grounding the system.
- The connection requirements of the grid operator must be met.
- The grid voltage must be within the permissible range. The exact operating range of the inverter is specified in the operating parameters.

#### Procedure:

1. Disconnect the circuit breaker and secure it against reconnection.
2. Dismantle the AC cable by 50 mm.
3. Shorten L1, L2, L3 and N by 8 mm each so that the grounding conductor is 8 mm longer. This ensures that the grounding conductor is the last to be pulled from the screw terminal in the event of tensile strain.
4. Strip the insulation of L1, L2, L3, N and the grounding conductor by 12 mm.
5. In the case of fine stranded wire, L1, L2, L3, N and the grounding conductor are to be fitted with bootlace ferrules.
6. Assemble the AC connector and connect the conductor to the AC connector (see manual of the AC connector).
7. Ensure that all conductors are securely connected to the AC connector.



8. Plug the AC connector into the jack for the AC connection. When doing so, align the AC connector so that the key on the inverter AC jack is inserted into the keyway on the AC connector bush insert.

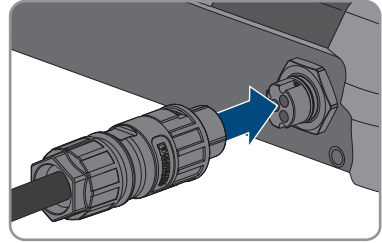

## 6.2.3 Connecting Additional Grounding

### ⚠ QUALIFIED PERSON

If additional grounding or equipotential bonding is required locally, you can connect additional grounding to the inverter. This prevents touch current if the grounding conductor on the AC connector fails. The necessary ring terminal lug and the screw are included in the scope of delivery of the inverter.

#### Additionally required material (not included in the scope of delivery):

- 1 grounding cable

#### Cable requirements:

#### **i** Use of fine-stranded conductors

You can use an inflexible or a flexible, fine-stranded conductor.

- When using a fine-stranded conductor, it has to be double crimped by a ring terminal lug. Make sure that no insulated conductor is visible when pulling or bending. This will ensure sufficient strain relief by means of the ring terminal lug.

- Grounding cable cross-section: max. 10 mm<sup>2</sup>

#### Procedure:

1. Strip the grounding cable insulation.
2. Insert the stripped part of the grounding cable into the ring terminal lug and crimp using a crimping tool.

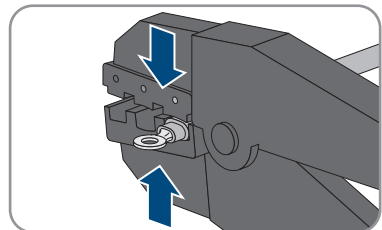

3. Insert the pan head screw M5x12 into the screw hole in the ring terminal lug and screw the ring terminal lug with screw firmly onto the connection point for additional grounding using a Torx screwdriver (TX 25, torque: 2.5 Nm).

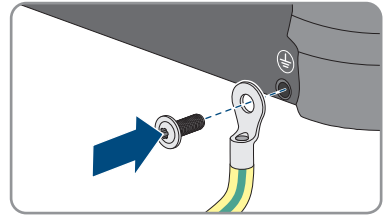

### 6.3 Connecting the Network Cables

#### ⚠ QUALIFIED PERSON

#### ⚠ DANGER

#### Danger to life due to electric shock in case of overvoltages and if surge protection is missing

Overvoltages (e. g. in the event of a flash of lightning) can be further conducted into the building and to other connected devices in the same network via the network cables or other data cables if there is no surge protection. Touching live parts and cables results in death or lethal injuries due to electric shock.

- Ensure that all devices in the same network are integrated in the existing overvoltage protection.
- When laying the network cable outdoors, ensure that there is suitable surge protection at the network cable transition from the product outdoors to the network inside the building.
- The Ethernet interface of the inverter is classified as "TNV-1" and offers protection against overvoltages of up to 1.5 kV.

#### Additionally required material (not included in the scope of delivery):

- 1 network cable

#### Cable requirements:

The cable length and quality affect the quality of the signal. Observe the following cable requirements.

- Cable type: 100BaseTx
- Cable category: Cat5, Cat5e, Cat6, Cat6a or Cat7
- Plug type: RJ45 of Cat5, Cat5e, Cat6 or Cat6a
- Shielding: SF/UTP, S/UTP, SF/FTP or S/FTP
- Number of insulated conductor pairs and insulated conductor cross-section: at least 2 x 2 x 0.22 mm<sup>2</sup>
- Maximum cable length between two nodes when using patch cables: 50 m
- Maximum cable length between two nodes when using installation cables: 100 m
- UV-resistant for outdoor use

## NOTICE

### Damage to the inverter due to moisture ingress

Moisture penetration can damage the inverter and impair its functionality.

- Connect the network cable with the supplied RJ45 protective sleeve to the inverter.

#### Procedure:

1.

### ⚠ DANGER

#### Danger to life due to electric shock

- Disconnect the inverter from all voltage sources (see Section 9, page 61).

2. Unscrew the protective cap from the network port.

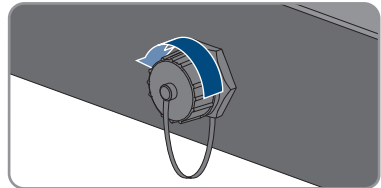

3. Press the cable support sleeve out of the threaded sleeve.

4. Thread the swivel nut and threaded sleeve over the network cable. At the same time, thread the network cable through the opening in the cable support sleeve.

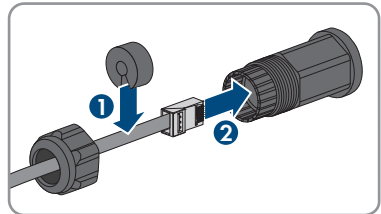

5. Press the cable support sleeve into the threaded sleeve.

6. Plug the network cable connector into the network port on the inverter and screw the threaded sleeve onto the network port thread on the inverter.

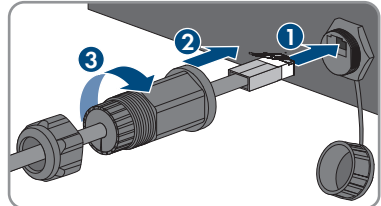

7. Screw the swivel nut onto the threaded sleeve.

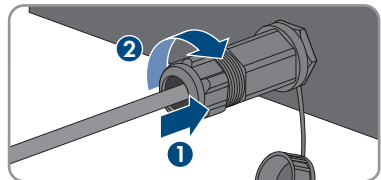

8. If you would like to establish a direct connection, connect the other end of the network cable directly to the end device.
9. If you would like to integrate the inverter into a local network, connect the other end of the network cable to the local network (e.g. via a router).

## 6.4 Connecting RS485 Devices

### ⚠ QUALIFIED PERSON

**Additionally required material (not included in the scope of delivery):**

- One communication cable for RS485 communication
- One M12 plug, 4-pole

**Signal assignment:**

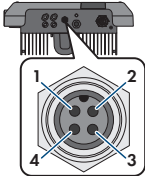
	Pin connector	Signal	TS4 Gateway	Insulated conductor color
	1	GND	-	
	2	+12 V	+	
	3	Data-	B	
	4	Data+	A	

**Procedure:**

1.

### ⚠ DANGER

#### Danger to life due to electric shock

- Disconnect the inverter from all voltage sources (see Section 9, page 61).

2. Assemble the M12 plug and connect the RS485 cable to the plug (see manual of the M12 connector).
3. Ensure that all conductors are correctly connected to the M12 plug.
4. Unscrew the protective cap from the jack for the RS485 communication connection.

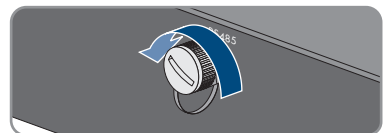

5. Plug the M12 connector into the jack for the RS485 communication connection and screw tight. When doing so, align the connector so that the key on the inverter AC jack is inserted into the keyway on the plug.

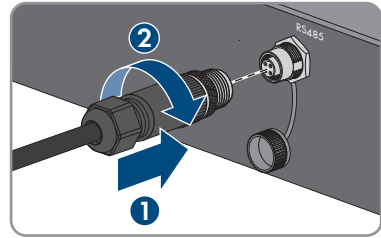

## 6.5 Mounting the WLAN Antenna

### ⚠ QUALIFIED PERSON

#### Requirement:

- The WLAN antenna supplied must be used.

#### Procedure:

1.

### ⚠ DANGER

#### Danger to life due to electric shock

- Disconnect the inverter from all voltage sources (see Section 9, page 61).

2. Remove the protective cap from the jack on the inverter.
3. Plug the WLAN antenna into the jack and screw tight (torque: 1 Nm).

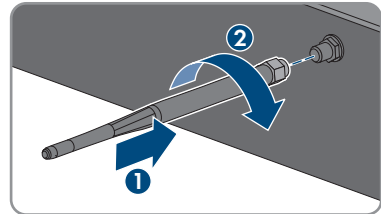

4. Pull on the WLAN antenna to ensure that the WLAN antenna is securely in place.

## 6.6 DC Connection

### 6.6.1 Requirements for the DC Connection

#### Connection options:

The inverter has two DC inputs, to each of which one string can be connected in normal operation.

You have the option of operating the DC inputs A and B in parallel, and therefore of connecting several strings to the inverter.

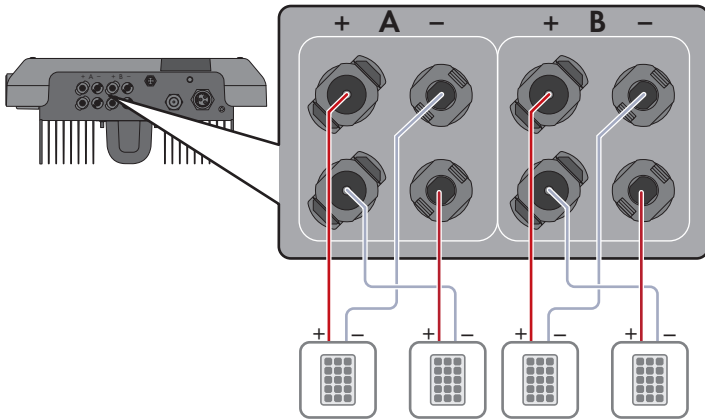

Figure 7: Connection overview for normal operation

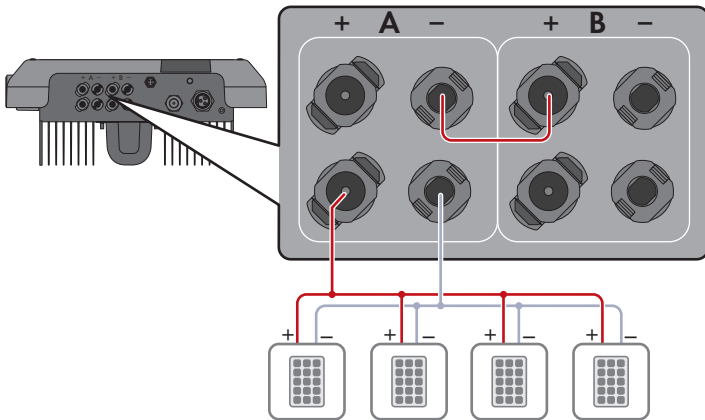

Figure 8: Connection overview for parallel connection of the DC inputs A and B

**Requirements for the PV modules per input:**

- All PV modules should be of the same type.
- All PV modules should be aligned and tilted identically.
- On the coldest day based on statistical records, the open-circuit voltage of the PV array must never exceed the maximum input voltage of the inverter.
- The same number of series-connected PV modules must be connected to each string.
- The maximum input current per string must be maintained and must not exceed the through-fault current of the DC connectors (see Section 13 "Technical Data", page 88).
- The thresholds for the input voltage and the input current of the inverter must be adhered to (see Section 13 "Technical Data", page 88).
- The positive connection cables of the PV modules must be equipped with positive DC connectors (see Section 6.6.2, page 31).
- The negative connection cables of the PV modules must be equipped with the negative DC connectors (see Section 6.6.2, page 31).

**i Use of Y adapters for parallel connection of strings**

The Y adapters must not be used to interrupt the DC circuit.

- Do not use the Y adapters in the immediate vicinity of the inverter. The adapters must not be visible or freely accessible.
- In order to interrupt the DC circuit, always disconnect the inverter as described in this document (see Section 9, page 61).

**6.6.2 Assembling the DC Connectors****⚠ QUALIFIED PERSON**

For connection to the inverter, all PV module connection cables must be fitted with the DC connectors provided. Assemble the DC connectors as described in the following. The procedure is identical for both connectors (+ and -). The graphics for the procedure are shown for only the positive connector as an example. Pay attention to the correct polarity when assembling the DC connectors. The DC connectors are marked with the symbols "+" and "-".

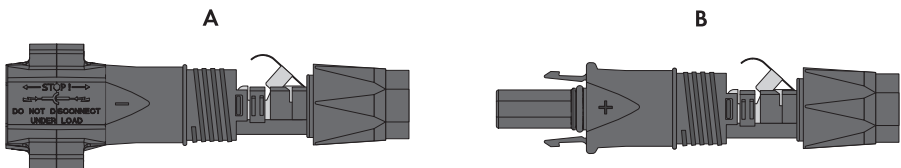

Figure 9: Negative (A) and positive (B) DC connectors

**Cable requirements:**

- Cable type: PV1-F, UL-ZKLA, USE2
- External diameter: 5 mm to 8 mm
- Conductor cross-section: 2.5 mm<sup>2</sup> to 6 mm<sup>2</sup>
- Qty single wires: minimum 7
- Nominal voltage: minimum 1000 V
- Using bootlace ferrules is not allowed.

**⚠ DANGER****Danger to life due to high voltages on the DC conductors**

When exposed to sunlight, the PV array generates dangerous DC voltage which is present in the DC conductors. Touching the DC conductors can lead to lethal electric shocks.

- Ensure that the inverter is disconnected from all voltage sources.
- Do not touch non-insulated cable ends.
- Do not touch the DC conductors.

**NOTICE****Destruction of the inverter due to overvoltage**

If the open-circuit voltage of the PV modules exceeds the maximum input voltage of the inverter, the inverter can be destroyed due to overvoltage.

- If the open-circuit voltage of the PV modules exceeds the maximum input voltage of the inverter, do not connect any strings to the inverter and check the design of the PV system.

**Procedure:**

1. Strip 12 mm of the cable insulation.
2. Insert the stripped cable into the DC connector up to the stop. When doing so, ensure that the stripped cable and the DC connector are of the same polarity.
3. Press the clamping bracket down until it audibly snaps into place.

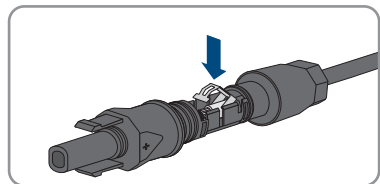
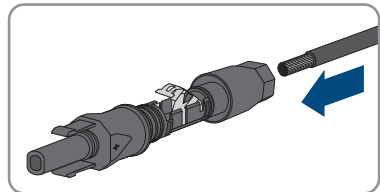



- ☑ The stranded wire can be seen inside the clamping bracket chamber.

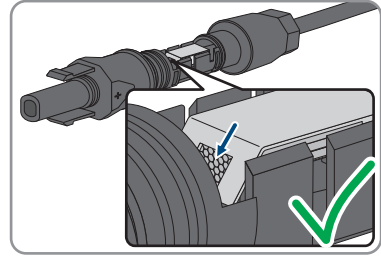

4. If the stranded wire is not visible in the chamber, the cable is not correctly inserted and the connector must be reassembled. To do this, the cable must be removed from the connector.

- Release the clamping bracket. To do so, insert a screwdriver (blade width: 3.5 mm) into the clamping bracket and pry the clamping bracket open.

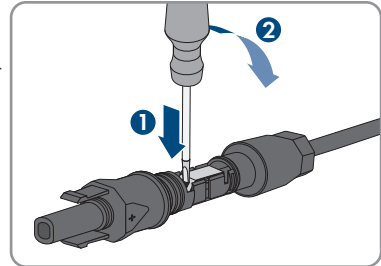

- Remove the cable and go back to step 2.

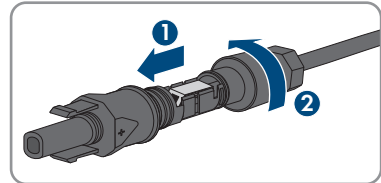

5. Push the swivel nut up to the thread and tighten (torque: 2 Nm).

### 6.6.3 Connecting the PV Array

#### ⚠ QUALIFIED PERSON

#### NOTICE

##### **Destruction of the inverter due to overvoltage**

If the open-circuit voltage of the PV modules exceeds the maximum input voltage of the inverter, the inverter can be destroyed due to overvoltage.

- If the open-circuit voltage of the PV modules exceeds the maximum input voltage of the inverter, do not connect any strings to the inverter and check the design of the PV system.

#### NOTICE

##### **Destruction of the measuring device due to overvoltage**

- Only use measuring devices with a DC input voltage range of 1000 V or higher.

**NOTICE****Damage to the DC connectors due to the use of contact cleaner of other cleaning agents**

Some contact cleaners or other cleaning agents may contain substances that decompose the plastic of the DC connectors.

- Do not use contact cleaners or other cleaning agents for cleaning the DC connectors.

**NOTICE****Damage to the inverter due to ground fault on DC side during operation**

Due to the transformerless topology of the product, the occurrence of ground faults on DC side during operation can lead to irreparable damage. Damages to the product due to a faulty or damaged DC installation are not covered by warranty. The product is equipped with a protective device that checks whether a ground fault is present during the starting sequence. The product is not protected during operation.

- Ensure that the DC installation is carried out correctly and no ground fault occurs during operation.

**Procedure:**

1. Ensure that the circuit breaker is switched off and that it cannot be reconnected.
2. If an external DC load-break switch is installed, disconnect the external DC load-break switch from all voltage sources.
3. Set the DC load-break switch of the inverter to position **O**.

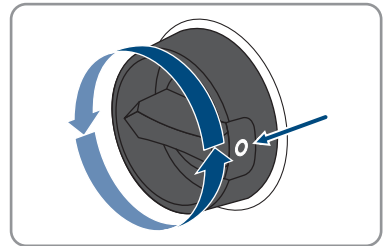

4. Measure the PV array voltage. Ensure that the maximum input voltage of the inverter is adhered to and that there is no ground fault in the PV array.
5. Check whether the DC connectors have the correct polarity.  
If the DC connector is equipped with a DC cable of the wrong polarity, the DC connector must be reassembled. The DC cable must always have the same polarity as the DC connector.
6. Ensure that the open-circuit voltage of the PV array does not exceed the maximum input voltage of the inverter.

7. Connect the assembled DC connectors to the inverter.

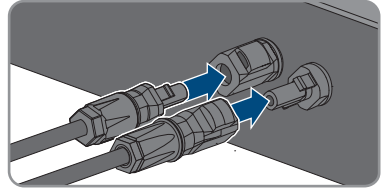

- ☑ The DC connectors snap into place.

8. Ensure that all DC connectors are securely in place.

## 9. NOTICE

### Damage to the product due to sand, dust and moisture ingress if the DC inputs are not closed

The product is only properly sealed when all unused DC inputs are closed with DC connectors and sealing plugs. Sand, dust and moisture penetration can damage the product and impair its functionality.

- Seal all unused DC inputs using the DC connectors and sealing plugs as described in the following. When doing so, do not plug the sealing plugs directly into the DC inputs on the inverter.

10. For unused DC connectors, push down the clamping bracket and push the swivel nut up to the thread.

11. Insert the sealing plug into the DC connector.

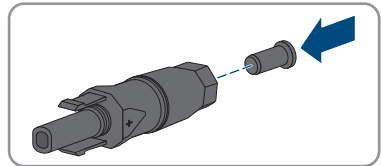

12. Insert the DC connectors with sealing plugs into the corresponding DC inputs on the inverter.

- ☑ The DC connectors snap into place.

13. Ensure that the DC connectors with sealing plugs are securely in place.

## 6.6.4 Disassembling the DC Connectors

### ⚠ QUALIFIED PERSON

To disassemble the DC connectors (e.g. due to faulty assembly), proceed as follows.

## ⚠ DANGER

### Danger to life due to electric shock when touching exposed DC conductors or DC plug contacts if the DC connectors are damaged or loose

The DC connectors can break or become damaged, become free of the DC cables, or no longer be connected correctly if the DC connectors are released and disconnected incorrectly. This can result in the DC conductors or DC plug contacts being exposed. Touching live DC conductors or DC plug connectors will result in death or serious injury due to electric shock.

- Wear insulated gloves and use insulated tools when working on the DC connectors.
- Ensure that the DC connectors are in perfect condition and that none of the DC conductors or DC plug contacts are exposed.
- Carefully release and remove the DC connectors as described in the following.

#### Procedure:

1. Release and remove the DC connectors. To do so, insert a flat-blade screwdriver or an angled screwdriver (blade width: 3.5 mm) into one of the side slots and pull the DC connectors out. When doing so, do not lever the DC connectors out, but insert the tool into one of the side slots only to release the locking mechanism, and do not pull on the cable.
2. Remove the DC connector swivel nut.

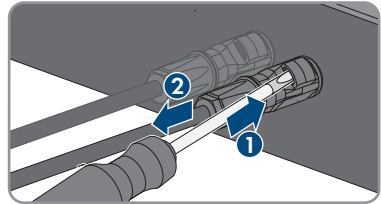

3. Unlock the DC connector. To do this, insert a flat-blade screwdriver (blade width: 3.5 mm) into the side catch mechanism and pry the catch mechanism open.

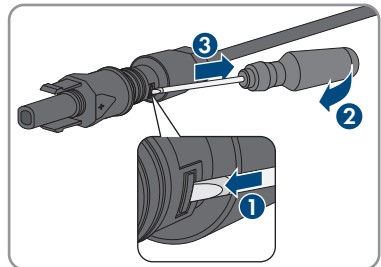
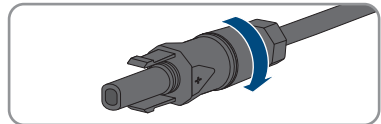

4. Carefully pull the DC connector apart.

5. Release the clamping bracket. To do so, insert a flat-blade screwdriver (blade width: 3.5 mm) into the clamping bracket and pry the clamping bracket open.

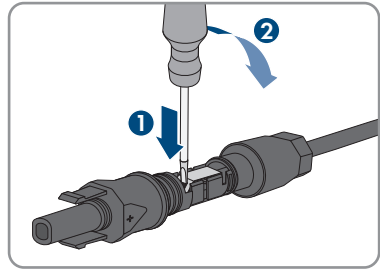

6. Remove the cable.

## 7 Commissioning

### 7.1 Commissioning Procedure

#### QUALIFIED PERSON

This section describes the commissioning procedure and gives an overview of the steps you must perform in the prescribed order.

Procedure	See
1. Commission the inverter.	Section 7.2, page 38
2. Establish a connection to the user interface of the inverter. There are various connection options to choose from for this: <ul style="list-style-type: none"> <li>• Direct connection via WLAN</li> <li>• Direct connection via Ethernet</li> <li>• Connection via WLAN in the local network</li> <li>• Connection via Ethernet in the local network</li> </ul>	Section 8.1, page 44
3. Log into the user interface.	Section 8.2, page 48
4. Select the inverter configuration option. Please note that the SMA Grid Guard code for changing the grid-relevant parameters must be available after completion of the first ten feed-in hours or installation assistant (see "Application for the SMA Grid Guard code" available at <a href="http://www.SMA-Solar.com">www.SMA-Solar.com</a> ).	Section 7.3, page 40
5. Ensure that the country data set has been configured correctly.	Section 8.11, page 56
6. For PV systems in Italy or Dubai: Start the self-test.	Section 7.4, page 42
7. Make further inverter settings as needed.	Section 8, page 44

### 7.2 Commissioning the Inverter

#### QUALIFIED PERSON

#### Requirements:

- The AC circuit breaker must be correctly rated and mounted.
- The inverter must be correctly mounted.
- All cables must be correctly connected.

#### Procedure:

1. Switch on the AC circuit breaker.

2. Turn the DC load-break switch of the inverter to position I.

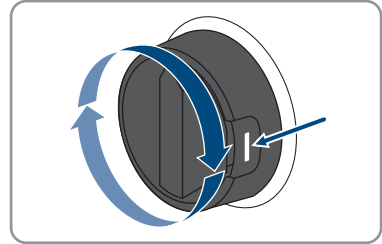

- ☑ All three LEDs light up. The start-up phase begins.
  - ☑ All three LEDs go out again after approximately 90 seconds.
  - ☑ The green LED starts to flash and, if the inverter is connected via Speedwire, the blue LED also starts to flash. If the green LED is still flashing after some time, the conditions for activating feed-in operation are not yet met. As soon as the conditions for feed-in operation are met, the inverter starts with feed-in operation and, depending on the available power, the green LED will light up continuously or it will pulse.
3. If the red LED is glowing, an error has occurred that must be rectified (see Section 11, page 64).

## 7.3 Selecting a configuration option

### ⚠ QUALIFIED PERSON

After you have logged onto the user interface as **Installer**, the **Configuring the Inverter** page opens.

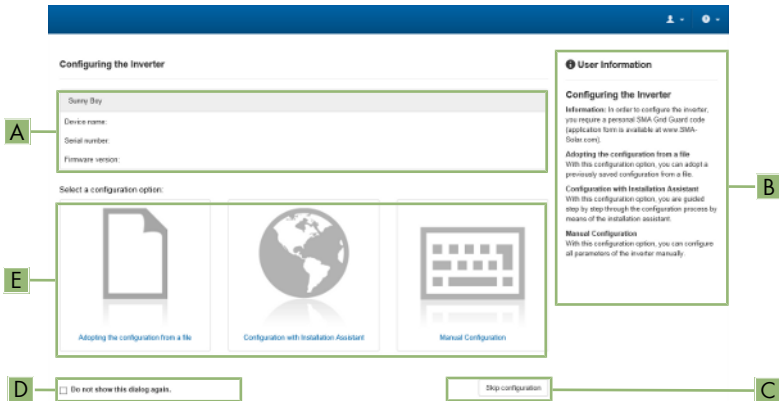

Figure 10: Layout of the **Configuring the Inverter** page

Position	Designation	Description
A	Device information	Provides the following information: <ul style="list-style-type: none"> <li>• Device name</li> <li>• Inverter serial number</li> <li>• Inverter firmware version</li> </ul>
B	User information	Provides brief information on the listed configuration options
C	Skip configuration	Offers the option of skipping the inverter configuration and go directly to the user interface (not recommended)
D	Checkbox	Allows you to choose not to have the displayed page displayed again when the user interface is called up again
E	Configuration options	Provides a selection of the various configuration options

#### Procedure:

On the **Configuring the Inverter** page, different configuration options are available to choose from. Select one of the options and proceed for the selected option as described below. SMA Solar Technology AG recommends carrying out the configuration with the installation assistant. This way, you ensure that all relevant parameters are set for optimal inverter operation.



- Adoption of configuration from a file
- Configuration with the installation assistant (recommended)
- Manual configuration

### **i** Accepting the settings

Saving the made settings is indicated by an hourglass symbol on the user interface. If the DC voltage is sufficient, the data is transferred directly to the inverter and accepted. If the DC voltage is too low (e. g. in the evening), the settings are saved, but they cannot be directly transferred to or accepted by the inverter. As long as the inverter has not yet received and accepted the settings, the hourglass symbol will continue to be displayed on the user interface. The settings will be accepted when there is sufficient DC voltage applied and the inverter restarts. As soon as the hourglass symbol appears on the user interface, the settings have been saved. The settings will not be lost. You can log off of the user interface and leave the system.

## Adopting the Configuration from a File

You can adopt the inverter configuration from a file. To do this, there must be an inverter configuration saved to a file.

### Procedure:

1. Select the configuration option **Adopting configuration from a file**.
2. Select **[Browse...]** and select the desired file.
3. Select **[Import file]**.

## Configuring the Installation Assistant (Recommended)

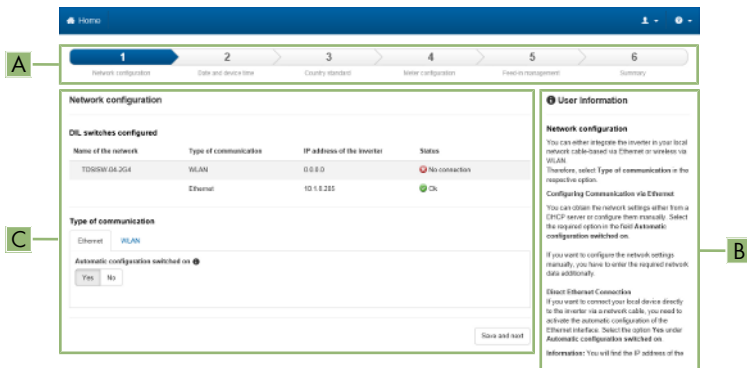

Figure 11: Layout of the installation assistant (example)

Position	Designation	Description
A	Configuration steps	Overview of the installation assistant steps. The number of steps depends on the type of device and the additionally installed modules. The current step is highlighted in blue.

Position	Designation	Description
B	User information	Information about the current configuration step and the setting options of the configuration step.
C	Configuration field	You can make settings in this field.

**Procedure:**

1. Select the configuration option **Configuration with Installation Assistant**.
  - The installation assistant will open.
2. Follow the installation assistant steps and make the settings appropriate for your system.
3. For every setting made in a step, select [**Save and next**].
  - In the last step, all made settings are listed in a summary.
4. To save the settings to a file, select [**Export a summary**] and save the file on your computer, tablet PC or smartphone.
5. To export all parameters and their settings, select [**Export all parameters**]. This exports all parameters and their settings into an HTML file.
6. To correct settings you made, select [**Back**], navigate to the desired step, correct settings and select [**Save and continue**].
7. Once all settings are correct, select [**Next**] in the summary.
  - The start page of the user interface opens.

**Manual configuration**

You can configure the inverter manually by setting the desired parameters.

**Procedure:**

1. Select the configuration option **Manual Configuration**.
  - The **Device Parameters** menu on the user interface will open and all available parameter groups of the inverter will be displayed.
2. Select [**Edit parameters**].
3. Select the desired parameter group.
  - All available parameters of the parameter group will be displayed.
4. Set the desired parameters.
5. Select [**Save all**].
  - The inverter parameters are set.

**7.4 Starting the Self-Test (for Italy and Dubai)****⚠ QUALIFIED PERSON**

The self-test is only required for inverters that are to be commissioned in Italy or Dubai. The Italian standard CEI 0-21 and the DEWA (Dubai Electricity and Water Authority) stipulate that all inverters that feed into the utility grid are equipped with a self-test function. During the self-test, the inverter will consecutively check the reaction times for overvoltage, undervoltage, maximum frequency and minimum frequency.

The self-test changes the upper and lower disconnection values for each protective function on a linear basis for frequency monitoring and voltage monitoring. As soon as the measured value exceeds the permitted disconnection threshold, the inverter disconnects from the utility grid. In this way, the inverter determines the reaction time and checks itself.

After the self-test has been completed, the inverter automatically switches back to feed-in operation, resets the original disconnection conditions and connects to the utility grid. The test takes approximately three minutes.

**Requirements:**

- The country data set of the inverter must be set to **CEI 0-21 internal** or **DEWA 2016 internal**.

**Procedure:**

1. Select the menu **Device Configuration**.
2. Select [**Settings**].
3. Select [**Starting the Self-Test**] in the subsequent context menu.
4. Follow the instructions appearing in the dialog and save the report of the self-test where necessary.

## 8 Operation

### 8.1 Establishing a connection to the user interface

#### 8.1.1 Establishing a Direct Connection via Ethernet

**Requirements:**

- The product must be commissioned.
- An end device (e.g. computer) with an Ethernet interface must be available.
- The product must be connected directly to the end device.
- The respective latest version of one of the following web browsers must be installed: Chrome, Edge, Firefox, Internet Explorer or Safari.
- The SMA Grid Guard code of the Installer must be available for the changing of grid-relevant settings after completion of the first ten feed-in hours or installation assistant (see "Application for SMA Grid Guard Code" at [www.SMA-Solar.com](http://www.SMA-Solar.com)).

**i IP address of the inverter**

- Standard inverter IP address for direct connection via Ethernet: 169.254.12.3

**Procedure:**

1. Open the web browser of your device, enter the IP address **169.254.12.3** in the address line and press the enter key.
  2. **i Web browser signals a security vulnerability**

After the IP address has been confirmed by pressing the enter key, a message might appear indicating that the connection to the user interface of the inverter is not secure. SMA Solar Technology AG guarantees that calling up the user interface is secure.

    - Continue loading the user interface.
- The login page of the user interface opens.

#### 8.1.2 Establishing a direct connection via WLAN

**Requirements:**

- The product must be commissioned.
- The respective latest version of one of the following web browsers must be installed: Chrome, Edge, Firefox, Internet Explorer or Safari.
- JavaScript must be enabled in the web browser of the end device.
- The SMA Grid Guard code of the Installer must be available for the changing of grid-relevant settings after completion of the first ten feed-in hours or installation assistant (see "Application for SMA Grid Guard Code" at [www.SMA-Solar.com](http://www.SMA-Solar.com)).

### **i** SSID, IP address and necessary passwords

- SSID in WLAN: SMA[serial number] (e.g. SMA0123456789)
- Standard WLAN password (usable until completion of the configuration by means of the installation assistant or prior to the end of the first ten feed-in hours): SMA12345
- Device-specific WLAN password (usable for initial configuration to completion of the first ten feed-in hours): see WPA2-PSK on the type label of the inverter or on the back of the manual included in the delivery
- Standard IP address for a direct connection via WLAN outside of a local network:  
192.168.12.3

### **i** Importing and exporting files with end devices having an iOS operating system is not possible.

For technical reasons, importing and exporting files (e.g. importing an inverter configuration, saving the current inverter configuration or exporting events and parameters) is not possible with mobile end devices having an iOS operating system.

- Use an end device that does not have an iOS operating system for importing and exporting files.

The procedure can be different depending on the end devices. If the procedure described does not apply to your end device, establish the direct connection via WLAN as described in the manual of your end device.

#### **Procedure:**

1. If your end device has a WPS function:
  - Activate the WPS function on the inverter. To do this, tap on the enclosure lid of the inverter twice.
    - The blue LED flashes quickly for approx. two minutes. The WPS function is active during this time.
  - Activate the WPS on your end device.
    - The connection with your end device will be established automatically. It can take up to 20 seconds for this connection to be established.
2. If your end device has not a WPS function:
  - Search for WLAN networks with your end device.
  - Select the SSID of the inverter **SMA[serial number]** in the list with the found WLAN networks.
  - Enter the inverter WLAN password. Within the first ten feed-in hours and prior to completing the configuration by means of the installation assistant, you must use the standard WLAN password **SMA12345**. After the first ten feed-in hours or after completing the configuration by means of the installation assistant, you must use the device-specific WLAN password (WPA2-PSK) of the inverter. You find the WLAN password (WPA2-PSK) on the type label.
3. Enter the IP address **192.168.12.3** or, if your device supports mDNS services, **SMA[serial number].local** or **https://SMA[serial number]** in the address bar of the web browser and press the enter key.

#### 4. **i** Web browser signals a security vulnerability

After the IP address has been confirmed by pressing the enter key, a message might appear indicating that the connection to the user interface of the inverter is not secure. SMA Solar Technology AG guarantees that calling up the user interface is secure.

- Continue loading the user interface.
- The login page of the user interface opens.

### 8.1.3 Establishing a Connection via Ethernet in the local network

#### **i** New IP address for connecting with a local network

If the product is connected to a local network (e.g. via a router), the product will receive a new IP address. Depending on the type of configuration, the new IP address will be assigned automatically by the DHCP server (router) or manually by you. Upon completion of the configuration, the product can only be reached via the following access addresses:

- Generally applicable access address: IP address manually assigned or assigned by the DHCP server (router) (identification via network scanner software or network configuration of the router).
- Access address for Apple and Linux systems: SMA[serial number].local (e.g. SMA0123456789.local)
- Access address for Windows and Android systems: https://SMA[serial number] (e.g. http://SMA0123456789)

#### Requirements:

- The product must be connected to the local network via a network cable (e.g. via a router).
- The product must be integrated into the local network. Tip: There are various methods of integrating the product into the local network with the aid of the installation assistant.
- An end device (e.g. computer, tablet PC or smartphone) must be available.
- The end device must be in the same local network as the product.
- The respective latest version of one of the following web browsers must be installed: Chrome, Edge, Firefox, Internet Explorer or Safari.
- The SMA Grid Guard code of the Installer must be available for the changing of grid-relevant settings after completion of the first ten feed-in hours or installation assistant (see "Application for SMA Grid Guard Code" at [www.SMA-Solar.com](http://www.SMA-Solar.com)).

#### Procedure:

1. Open the web browser of your end device, enter the IP address of the inverter in the address line of the web browser and press the enter key.

## 2. **i** Web browser signals a security vulnerability

After the IP address has been confirmed by pressing the enter key, a message might appear indicating that the connection to the user interface of the inverter is not secure. SMA Solar Technology AG guarantees that calling up the user interface is secure.

- Continue loading the user interface.

The login page of the user interface opens.

## 8.1.4 Establishing a Connection via WLAN in the Local Network

### **i** New IP address for connecting with a local network

If the product is connected to a local network (e.g. via a router), the product will receive a new IP address. Depending on the type of configuration, the new IP address will be assigned automatically by the DHCP server (router) or manually by you. Upon completion of the configuration, the product can only be reached via the following access addresses:

- Generally applicable access address: IP address manually assigned or assigned by the DHCP server (router) (identification via network scanner software or network configuration of the router).
- Access address for Apple and Linux systems: SMA[serial number].local (e.g. SMA0123456789.local)
- Access address for Windows and Android systems: https://SMA[serial number] (e.g. http://SMA0123456789)

#### Requirements:

- The product must be commissioned.
- The product must be integrated into the local network. Tip: There are various methods of integrating the product into the local network with the aid of the installation assistant.
- The end device must be in the same local network as the product.
- The respective latest version of one of the following web browsers must be installed: Chrome, Edge, Firefox, Internet Explorer or Safari.
- The SMA Grid Guard code of the Installer must be available for the changing of grid-relevant settings after completion of the first ten feed-in hours or installation assistant (see "Application for SMA Grid Guard Code" at [www.SMA-Solar.com](http://www.SMA-Solar.com)).

### **i** Importing and exporting files with end devices having an iOS operating system is not possible.

For technical reasons, importing and exporting files (e.g. importing an inverter configuration, saving the current inverter configuration or exporting events and parameters) is not possible with mobile end devices having an iOS operating system.

- Use an end device that does not have an iOS operating system for importing and exporting files.

#### Procedure:

1. Enter the IP address of the inverter in the address bar of the web browser.

## 2. **Web browser signals a security vulnerability**

After the IP address has been confirmed by pressing the enter key, a message might appear indicating that the connection to the user interface of the inverter is not secure. SMA Solar Technology AG guarantees that calling up the user interface is secure.

- Continue loading the user interface.

The login page of the user interface opens.

## 8.2 Logging In and Out of the User Interface

After a connection to the user interface of the inverter has been established, the login page opens. Log onto the user interface as described below.

### Log in as Installer or User for the First Time

#### Procedure:

1. In the drop-down list **Language**, select the desired language.
2. In the **User group** drop-down list, select the entry **Installer** or **User**.
3. In the **New password** field, enter a new password for the selected user group.
4. In the **Repeat password** field, enter the new password again.
5. Select **Login**.

### Log in as the User or Installer

1. In the drop-down list **Language**, select the desired language.
2. In the **User group** drop-down list, select the entry **Installer** or **User**.
3. Enter the password in the field **Password**.
4. Select **Login**.

The start page of the user interface opens.

### Log Out as the User or Installer

1. On the right-hand side of the menu bar, select the menu **User Settings**.
2. In the subsequent context menu, select **[Logout]**.

The login page of the user interface opens. The logout was successful.



### 8.3 Start Page Design of the User Interface



Figure 12: Start page design of the user interface (example)

Position	Designation	Description
A	Menu	<p>Provides the following functions:</p> <ul style="list-style-type: none"> <li>• <b>Home</b> Opens the user interface homepage</li> <li>• <b>Instantaneous values</b> Current measured values of the inverter</li> <li>• <b>Device Parameters</b> The various operating parameters of the inverter can be viewed and configured here depending on the user group.</li> <li>• <b>Events</b> All events that have occurred in the selected time period are displayed here. The event types are <b>Information</b>, <b>Warning</b> and <b>Error</b>. Currently existing events of the types <b>Error</b> and <b>Warning</b> will be additionally displayed in the <b>Device status</b> viewlet. However, only the higher-priority event is displayed. If, for example, there is a Warning and an Error present at the same time, only the Error will be displayed.</li> <li>• <b>Device configuration</b> Various settings for the inverter can be made here. The selection available is dependent on which user group you are logged in as and the operating system of the device with which the user interface has been called up.</li> <li>• <b>Data</b> You will find all data that is saved in the internal memory of the inverter or on an external storage medium on this page.</li> </ul>
B	User settings	<p>Provides the following functions, depending on the user group logged in:</p> <ul style="list-style-type: none"> <li>• Starting the installation assistant</li> <li>• SMA Grid Guard login</li> <li>• Logout</li> </ul>
C	Help	<p>Provides the following functions:</p> <ul style="list-style-type: none"> <li>• Displaying information on Open Source licenses used</li> <li>• Link to the website of SMA Solar Technology AG</li> </ul>

Position	Designation	Description
D	Status bar	<p>Displays the following information:</p> <ul style="list-style-type: none"> <li>• Inverter serial number</li> <li>• Inverter firmware version</li> <li>• IP address of the inverter within the local network and/or IP address of the inverter during WLAN connection</li> <li>• With WLAN connection: Signal strength of WLAN connection</li> <li>• User group logged in</li> <li>• Date and device time of the inverter</li> </ul>
E	Current power and current consumption	<p>Temporal progression of the PV power and the power consumption of the household over the selected time period. Please note, the power consumption will only be displayed if an energy meter is installed in the PV system.</p>
F	Status display	<p>The various areas display information on the current status of the PV system.</p> <ul style="list-style-type: none"> <li>• <b>Device status</b> Displays whether the inverter is currently in a fault-free operating state or whether there is an Error or Warning present.</li> <li>• <b>Current power</b> Displays the power currently being generated by the inverter.</li> <li>• <b>Current consumption</b> Displays the current consumption of the household if an energy meter is installed in the PV system.</li> <li>• <b>Yield</b> Displays the energy yield of the inverter.</li> <li>• <b>Consumption</b> Displays the energy consumption of the household if an energy meter is installed in the PV system.</li> <li>• <b>Feed-in management</b> Displays whether the inverter is currently limiting its active power.</li> </ul>

## 8.4 Activating the Smart Inverter Screen

With the Smart Inverter Screen, the most important inverter data is displayed directly on the user interface login page. To activate the Smart Inverter Screen, proceed as listed in the following.

### Procedure:

1. Activate the user interface (see Section 8.1, page 44).
2. Log in as **Installer** or **User**.

3. Select the menu **User Settings** (see Section 8.3, page 49) on the start page of the user interface.
  4. Select [**Smart Inverter Screen**].
- The Smart Inverter Screen has been activated.

## 8.5 Starting the Installation Assistant

### **⚠ QUALIFIED PERSON**

The installation assistant leads you step-by-step through the steps necessary for the initial configuration of the inverter.

#### Layout of the installation assistant

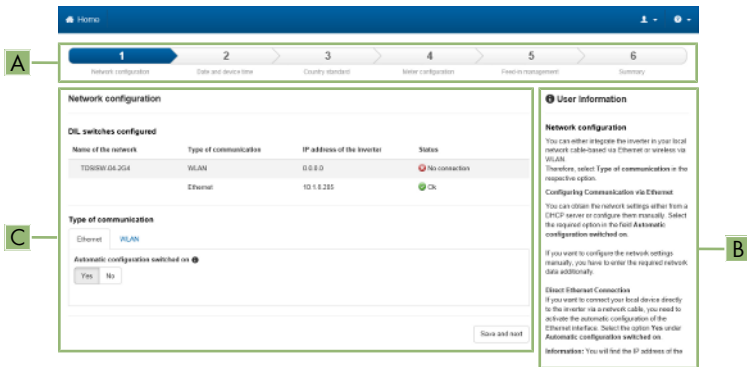

Figure 13: Layout of the installation assistant (example)

Position	Designation	Description
A	Configuration steps	Overview of the installation assistant steps. The number of steps depends on the type of device and the additionally installed modules. The current step is highlighted in blue.
B	User information	Information about the current configuration step and the setting options of the configuration step.
C	Configuration field	You can make settings in this field.

#### Requirement:

- When configuring after completion of the first ten feed-in hours or after exiting the installation assistant, the SMA Grid Guard code must be available in order to change the grid-relevant parameters (see "Application for SMA Grid Guard Code" at [www.SMA-Solar.com](http://www.SMA-Solar.com)).

#### Procedure:

1. Activate the user interface (see Section 8.1, page 44).
2. Log in as **Installer**.

3. Select the menu **User Settings** (see Section 8.3, page 49) on the start page of the user interface.
  4. In the context menu, select [**Starting the installation assistant**].
- The installation assistant will open.

## 8.6 Activate WPS Function

The WPS function can be used for different purposes:

- Automatic connection to a network (e.g. via router)
- Direct connection between the product and an end device

Depending on the intended application of the WPS function, the procedure for activation will vary.

### Activating WPS function for automatic connection to a network

#### Requirements:

- WLAN must be activated in the product.
- WPS must be activated on the router.

#### Procedure:

1. Activate the user interface (see Section 8.1, page 44).
  2. Log in as **Installer**.
  3. Start the installation assistant (see Section 8.5, page 52).
  4. Select **Network configuration**.
  5. Select **WPS for WLAN network** button in the **WLAN** tab.
  6. Select **Activate WPS**.
  7. Select **Save and next** and exit the installation assistant.
- The WPS function is activated and the automatic connection to the network can be established.

### Activating the WPS function for direct connection to the end device.

- Activate the WPS function on the inverter. To do this, tap on the enclosure lid of the inverter twice.
- The blue LED flashes quickly for approx. two minutes. The WPS function is active during this time.

## 8.7 Switching WLAN On and Off

The inverter is equipped with an activated WLAN interface as standard. If you do not want to use WLAN, you can switch the WLAN function off and switch it on again whenever needed. In doing so, you can switch the WLAN direct connection and the WLAN connection in the local network on independently of each other.

### **i** Switching on the WLAN function only possible via Ethernet connection

If you switch off both the WLAN function for the direct connection and for the connection in the local network, access to the inverter user interface and therefore reactivation of the WLAN interface is only possible via an Ethernet connection.

The basic procedure for changing operating parameters is explained in another section (see Section 8.10 "Changing Operating Parameters", page 55).

### Switching WLAN Off

If you would like to switch the WLAN function off completely, you must switch off both the direct connection and the connection in the local network.

#### Procedure:

- To switch off the direct connection in the parameter group **PV system communication > WLAN**, select the parameter **Soft-access-point is turned on** and set this to **No**.
- To switch off the connection in the local network in the parameter group **PV system communication > WLAN**, select the parameter **WLAN is turned on** and set this to **No**.

### Switching WLAN On

If you have switched the WLAN function for direct connection or for connection in the local network off, you can switch the WLAN function back on in accordance with the following procedure.

#### Requirement:

- If the WLAN function was previously switched off completely, the inverter must be connected to a computer or router via Ethernet.

#### Procedure:

- To switch on the WLAN direct connection, in the parameter group **PV system communication > WLAN**, select the parameter **Soft-access-point is turned on** and set this to **Yes**.
- To switch on the WLAN connection in the local network, in the parameter group **System communication > WLAN**, select the parameter **WLAN is turned on** and set this to **Yes**.

## 8.8 Switching the Dynamic Power Display Off

As standard, the inverter signals its power dynamically via the pulsing of the green LED. When doing so, the LED flashes on and off uniformly or is permanently lit at full power. The various gradations are related here to the set active power limit of the inverter. If this display is not desired, switch this function off in accordance with the following procedure. Once this has been done, the green LED is lit permanently to signalize feed-in operation.

The basic procedure for changing operating parameters is explained in another section (see Section 8.10 "Changing Operating Parameters", page 55).

#### Procedure:

- In the parameter group **Device > Operation**, select the parameter **Dynamic power display via green LED** and set this to **Off**.

## 8.9 Changing the Password

The password for the inverter can be changed for both user groups. Furthermore, the user group **Installer** can change the password for the user group **User** as well as its own password.

### Procedure:

1. Activate the user interface (see Section 8.1, page 44).
2. Log into the user interface (see Section 8.2, page 48).
3. Call up the menu **Device Parameters**.
4. Select [**Edit parameters**].
5. In the parameter group **User Rights > Access Control** change the password of the desired user group.
6. Select [**Save all**] to save the changes.

## 8.10 Changing Operating Parameters

The operating parameters of the inverter are set to certain values by default. You can change the operating parameters to optimize the performance of the inverter.

This section describes the basic procedure for changing operating parameters. Always change operating parameters as described in this section. Some function-sensitive parameters can only be viewed by qualified persons and can only be changed by qualified persons by entering the personal SMA Grid Guard code.

### No configuration via Sunny Explorer

Sunny Explorer does not support the configuration of inverters with their own user interface. The inverter can be detected via Sunny Explorer, however it is expressly not recommended to use Sunny Explorer to configure this inverter. SMA Solar Technology AG does not accept liability for missing or incorrect data and possibly resulting yield losses.

- Use the user interface for the configuration of the inverter.

### Requirements:

- Changes to grid-relevant parameters must be approved by the responsible grid operator.
- Changes to grid-relevant parameters must be approved by the responsible grid operator.

### Procedure:

1. Activate the user interface (see Section 8.1, page 44).
2. Log into the user interface (see Section 8.2, page 48).
3. Call up the menu **Device Parameters**.
4. Select [**Edit parameters**].
5. Log in using the SMA Grid Guard code to change those parameters designated by a lock (only for installers):
  - Select the menu **User Settings** (see Section 8.3, page 49).
  - In the subsequent context menu, select [**SMA Grid Guard login**].
  - Enter the SMA Grid Guard code and select [**Login**].

6. Expand the parameter group that contains the parameter which is to be configured.
  7. Change the desired parameters.
  8. Select [**Save all**] to save the changes.
- The inverter parameters are set.

### **i** Accepting the settings

Saving the made settings is indicated by an hourglass symbol on the user interface. If the DC voltage is sufficient, the data is transferred directly to the inverter and accepted. If the DC voltage is too low (e. g. in the evening), the settings are saved, but they cannot be directly transferred to or accepted by the inverter. As long as the inverter has not yet received and accepted the settings, the hourglass symbol will continue to be displayed on the user interface. The settings will be accepted when there is sufficient DC voltage applied and the inverter restarts. As soon as the hourglass symbol appears on the user interface, the settings have been saved. The settings will not be lost. You can log off of the user interface and leave the system.

## 8.11 Configuring the Country Data Set

### **⚠ QUALIFIED PERSON**

By default, the inverter is set to a universally valid country data set. You must adjust the country data set for the installation site.

### **i** The country data set must be set correctly.

If you select a country data set which is not valid for your country and purpose, it can cause a disturbance in the PV system and lead to problems with the grid operator. When selecting the country data set, you must always observe the locally applicable standards and directives as well as the properties of the PV system (e.g. PV system size, grid-connection point).

- If you are not sure which country data set is valid for your country or purpose, contact your grid operator for information on which country data set is to be configured.

The basic procedure for changing operating parameters is explained in another section (see Section 8.10 "Changing Operating Parameters", page 55).

#### **Procedure:**

- In the parameter group **Grid monitoring > Grid monitoring** select the parameter **Set country standard** and set the required country data set.

## 8.12 Configuring Feed-In Management

### **⚠ QUALIFIED PERSON**

#### **Starting the installation assistant**

1. Activate the user interface (see Section 8.1, page 44).
2. Log in as **Installer**.
3. Start the installation assistant (see Section 8.5, page 52).



4. Select [**Save and continue**] after each step up until the step **Configure grid management service**.
5. Make the settings as described in the following.

### Setting the connected line conductors

- In the tab **Feed-in management**, select the line conductor to which the inverter is connected from the drop-down list **Connected line conductors**.

### Making settings for systems with a higher unit (e.g. Sunny Home Manager)

1. Set **Feed-in management at the grid-connection point** to [**Off**].
2. Set **System control and power limitation** to [**On**].
3. In the drop-down list **Operating mode active power**, select the entry **Active power limitation P via system control**.
4. In the drop-down list **Operating mode for absent system control**, select the entry **Use fallback setting**.
5. In the field **Fallback active power P** enter the value to which the inverter is to limit its nominal power in case of a communication failure to the higher unit at the end of the timeout time.
6. In the field **Timeout**, enter the time that the inverter is to wait before it limits its nominal power to the set fallback value.
7. If, in the event of a 0% or 0 W specification, the inverter is not permitted to feed small amounts of active power into the utility grid, select the entry **Yes** in the drop-down list **Grid disconnection for 0% feeding**. This ensures that in the event of a 0% or 0 W specification, the inverter disconnects from the utility grid and does not feed in active power.

### Making settings for systems without higher-level unit (e.g. Sunny Home Manager).

1. Set **Feed-in management at the grid-connection point** to [**On**].
2. Enter the total PV array power in the field **Nominal PV system power**.
3. In the drop-down list **Operating mode of active power limitation at the grid-connection point**, select whether active power limitation is to be performed via a fixed specification in percent or in watts.
4. In the field **Set active power limit at the grid-connection point**, enter the value to which the active power at the grid-connection point is to be limited. The value must be set to **0** for zero export.
5. Set **System control and power limitation** to [**On**].
6. For system control and power limitation based on set default values, select the entry **Act. power lim. as % of Pmax** or **Active power limitation P in W** and enter the respective default value.
7. If the inverter itself is to limit the active power limitation to the grid-connection point, perform the following steps:
  - In the dropdown list **Operating mode Active power**, select **Act. power lim. via PV system ctrl**.

- In the drop-down list **Operating mode for absent system control**, select the entry **Values maintained**.
- In the drop-down list **Grid disconnection for 0% feeding** select the entry **No**.

## 8.13 Configuring the Modbus Function

### QUALIFIED PERSON

The Modbus interface is deactivated by default and the communication ports 502 set.

In order to access SMA inverters with SMA Modbus® or SunSpec® Modbus®, the Modbus interface must be activated. After activating the interface, the communication ports of both IP protocols can be changed. For information on commissioning and configuration of the Modbus interface, see the technical information "SMA and SunSpec Modbus® Interface" at [www.SMA-Solar.com](http://www.SMA-Solar.com).

For information on which Modbus registers are supported, see the technical information "Modbus® parameters and measured values" at [www.SMA-Solar.com](http://www.SMA-Solar.com).

#### Data security during activated Modbus interface

If you activate the Modbus interface, there is a risk that unauthorized users may access and manipulate the data or devices in your PV system.

To ensure data security, take appropriate protective measures such as:

- Set up a firewall
- Close unnecessary network ports.
- Only enable remote access via VPN tunnel.
- Do not set up port forwarding at the communication port in use.
- In order to deactivate the Modbus interface, reset the inverter to the default settings or deactivate the activated parameter again.

#### Procedure:

- Activate the Modbus interface and adjust the communication ports if necessary (see the technical information "SMA and SunSpec Modbus® Interface" at [www.SMA-Solar.com](http://www.SMA-Solar.com)).

## 8.14 Activating the Receipt of Control Signals (Only for Italy)

### QUALIFIED PERSON

In order for PV systems in Italy to receive control commands from the grid operator, set the following parameters.

The basic procedure for changing operating parameters is explained in another section (see Section 8.10 "Changing Operating Parameters", page 55).

Parameter	Value/range	Resolution	Default
Application ID	0 to 16384	1	16384
GOOSE-Mac address	01:0C:CD:01:00:00 to 01:0C:CD:01:02:00	1	01:0C:CD:01:00:00

**Procedure:**

1. Select the parameter group **External communication > IEC 61850 configuration**.
  2. In the field **Application ID**, enter the application ID of the grid operator gateway. You will receive this value from your grid operator. You can enter a value between 0 and 16384. The value 16384 indicates "deactivated".
  3. In the field **GOOSE-Mac address**, enter the MAC address of the grid operator gateway from which the inverter is to receive the control commands. You will receive this value from your grid operator.
- The receipt of control signals from the grid operator is activated.

## 8.15 Deactivating Grounding Conductor Monitoring

### QUALIFIED PERSON

If the inverter is to be installed in an IT network or another grid configuration in which deactivation of the grounding conductor monitoring is required, deactivate the grounding conductor monitoring as follows.

The basic procedure for changing operating parameters is explained in another section (see Section 8.10 "Changing Operating Parameters", page 55).

**Procedure:**

- In the parameter group **Grid monitoring > Grid monitoring > Country standard** set the parameter **PE connection monitoring** to **Off**.

## 8.16 Saving the Configuration in a File

You can save the current configuration of the inverter in a file. You can use this file as a data backup for this inverter and then import this file into this inverter again or another inverter from the same type or device family to configure the inverter. When saving, only the device parameters will be saved, not any passwords.

**Procedure:**

1. Activate the user interface (see Section 8.1, page 44).
2. Log into the user interface (see Section 8.2, page 48).
3. Select the menu **Device Configuration**.
4. Select [**Settings**].
5. In the context menu, select [**Saving the configuration in a file**].
6. Follow the instructions in the dialog.

## 8.17 Adopting a Configuration from a File

### QUALIFIED PERSON

To configure the inverter, you can adopt the configuration from a file. To be able to do this, you must first save the configuration of another inverter from the same type or device family in a file (see Section 8.16 "Saving the Configuration in a File", page 59). When saving, only the device parameters will be adopted, not any passwords.

**Requirements:**

- Changes to grid-relevant parameters must be approved by the responsible grid operator.
- The SMA Grid Guard code must be available (see "Application for SMA Grid Guard Code" at [www.SMA-Solar.com](http://www.SMA-Solar.com)).

**Procedure:**

1. Activate the user interface (see Section 8.1, page 44).
2. Log into the user interface as an **Installer**.
3. Select the menu **Device Configuration**.
4. Select [**Settings**].
5. In the context menu, select [**Adopting the configuration from a file**].
6. Follow the instructions in the dialog.

## 8.18 Updating the Firmware

**⚠ QUALIFIED PERSON**

If no automatic update is set in the communication product (e.g. SMA Data Manager or Sunny Home Manager) or in Sunny Portal, you have the option of carrying out a manual firmware update.

**Requirements:**

- An update file with the desired inverter firmware must be available. The update file is, for example, available for download on the product page of the inverter at [www.SMA-Solar.com](http://www.SMA-Solar.com). To download the update file, it is necessary to enter the serial number of the inverter.

**Procedure:**

1. Activate the user interface (see Section 8.1, page 44).
2. Log into the user interface (see Section 8.2, page 48).
3. Select the menu **Device Configuration**.
4. In the inverter row, click on the gear icon and select **Update firmware**.
5. Select [**Browse**] and select the update file for the inverter.
6. Select **Update firmware**.
7. Follow the instructions in the dialog.

## 9 Disconnecting the Inverter from Voltage Sources

### ⚠ QUALIFIED PERSON

Prior to performing any work on the inverter, always disconnect it from all voltage sources as described in this section. Always adhere to the prescribed sequence.

### NOTICE

#### Destruction of the measuring device due to overvoltage

- Only use measuring devices with a DC input voltage range of 1000 V or higher.

#### Procedure:

1. Disconnect the AC circuit breaker and secure it against reconnection.
2. Set the DC load-break switch of the inverter to **O**.

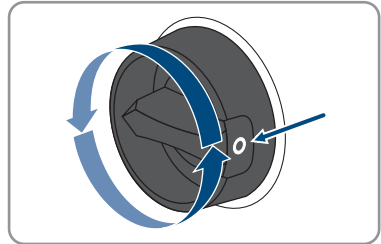

3. Wait until the LEDs have gone out.
4. Use a current clamp to ensure that no current is present in the DC cables.

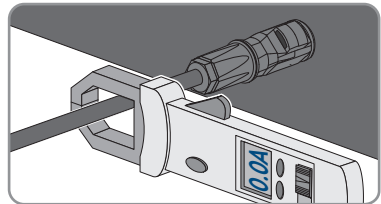

5.

### ⚠ DANGER

#### Danger to life due to electric shock when touching exposed DC conductors or DC plug contacts if the DC connectors are damaged or loose

The DC connectors can break or become damaged, become free of the DC cables, or no longer be connected correctly if the DC connectors are released and disconnected incorrectly. This can result in the DC conductors or DC plug contacts being exposed. Touching live DC conductors or DC plug connectors will result in death or serious injury due to electric shock.

- Wear insulated gloves and use insulated tools when working on the DC connectors.
- Ensure that the DC connectors are in perfect condition and that none of the DC conductors or DC plug contacts are exposed.
- Carefully release and remove the DC connectors as described in the following.

6. Release and remove the DC connectors. To do so, insert a flat-blade screwdriver or an angled screwdriver (blade width: 3.5 mm) into one of the side slots and pull the DC connectors out. When doing so, do not lever the DC connectors out, but insert the tool into one of the side slots only to release the locking mechanism, and do not pull on the cable.
7. Ensure that no voltage is present at the DC inputs on the inverter using a suitable measuring device.
8. Unscrew the AC connector and pull it out of the jack for the AC connection.

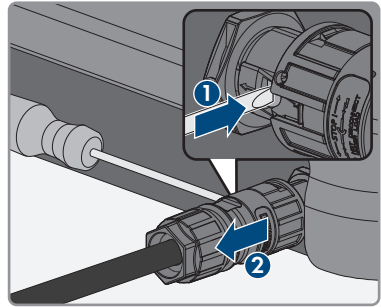
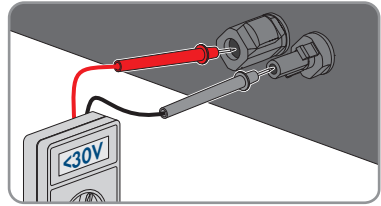
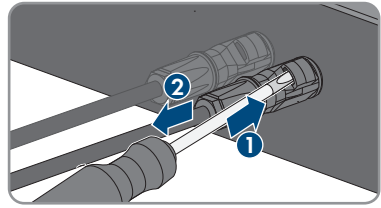

## 10 Cleaning the Inverter

### NOTICE

#### **Damage due to cleaning agents**

The use of cleaning agents may cause damage to the product and its components.

- Clean the product and all its components only with a cloth moistened with clear water.
- Ensure that the inverter is free of dust, foliage and other dirt.

# 11 Troubleshooting

## 11.1 Forgotten Password

If you have forgotten the password for the inverter, you can unlock the inverter with a Personal Unlocking Key (PUK). For each inverter, there is one PUK for each user group (**User** and **Installer**).  
Tip: With PV systems in Sunny Portal, you can also assign a new password via Sunny Portal for the user group **Installer**. The password for the user group **Installer** is the same as the system password in Sunny Portal.

### Procedure:

1. Request PUK (application form available at [www.SMA-Solar.com](http://www.SMA-Solar.com)).
2. Activate the user interface (see Section 8.1, page 44).
3. Enter the PUK instead of the password into the field **Password**.
4. Select **Login**.
5. Call up the menu **Device Parameters**.
6. Select [**Edit parameters**].
7. In the parameter group **User Rights > Access Control** change the password of the desired user group.
8. Select [**Save all**] to save the changes.

### PV Systems in Sunny Portal

The password for the user group **Installer** is also the system password for the PV system in Sunny Portal. Changing the password of the user group **Installer** can lead to the inverter no longer being able to be reached by Sunny Portal.

- Assign the changed password of the user group **Installer** as the new system password in Sunny Portal (see the Sunny Portal user manual at [www.SMA-Solar.com](http://www.SMA-Solar.com)).



## 11.2 Event Messages



Event number	Message, cause and corrective measures
101	<p data-bbox="311 236 594 268"><b>⚠ QUALIFIED PERSON</b></p> <p data-bbox="288 284 393 309"><b>Grid fault</b></p> <p data-bbox="288 320 983 376">The grid voltage or grid impedance at the connection point of the inverter is too high. The inverter has disconnected from the utility grid.</p> <p data-bbox="288 387 508 413"><b>Corrective measures:</b></p> <ul data-bbox="311 424 992 687" style="list-style-type: none"> <li data-bbox="311 424 992 595">• Check whether the grid voltage at the connection point of the inverter is permanently in the permissible range. If the grid voltage is outside the permissible range due to local grid conditions, contact the grid operator. The grid operator must agree with an adjustment of the voltage at the feed-in point or with a change of the monitored operating limits. If the grid voltage is permanently within the permissible range and this message is still displayed, contact the Service (see Section 14, page 94).</li> </ul>
301	<p data-bbox="311 703 594 735"><b>⚠ QUALIFIED PERSON</b></p> <p data-bbox="288 751 393 777"><b>Grid fault</b></p> <p data-bbox="288 788 995 900">The ten-minute average value of the grid voltage is no longer within the permissible range. The grid voltage or grid impedance at the connection point is too high. The inverter disconnects from the utility grid to maintain power quality.</p> <p data-bbox="288 911 508 936"><b>Corrective measures:</b></p> <ul data-bbox="311 948 992 1214" style="list-style-type: none"> <li data-bbox="311 948 992 1214">• During the feed-in operation, check whether the grid voltage at the connection point of the inverter is permanently in the permissible range. If the grid voltage is outside the permissible range due to local grid conditions, contact the grid operator. The grid operator must agree with an adjustment of the voltage at the feed-in point or with a change of the monitored operating limits. If the grid voltage is permanently within the permissible range and this message is still displayed, contact the Service (see Section 14, page 94).</li> </ul>
401	<p data-bbox="311 1230 594 1262"><b>⚠ QUALIFIED PERSON</b></p> <p data-bbox="288 1278 393 1303"><b>Grid fault</b></p> <p data-bbox="288 1315 1006 1370">The inverter has disconnected from the utility grid. A stand-alone grid or a very large change in the power frequency was detected.</p> <p data-bbox="288 1382 508 1407"><b>Corrective measures:</b></p> <ul data-bbox="311 1418 1006 1437" style="list-style-type: none"> <li data-bbox="311 1418 1006 1437">• Check the grid connection for significant short-term frequency fluctuations.</li> </ul>

Event number	Message, cause and corrective measures
501	<p data-bbox="311 188 596 220"><b>⚠ QUALIFIED PERSON</b></p> <p data-bbox="288 236 392 260"><b>Grid fault</b></p> <p data-bbox="288 272 992 325">The power frequency is not within the permissible range. The inverter has disconnected from the utility grid.</p> <p data-bbox="288 336 508 360"><b>Corrective measures:</b></p> <ul data-bbox="311 371 908 424" style="list-style-type: none"> <li data-bbox="311 371 908 424">• If possible, check the power frequency and observe how often fluctuations occur.</li> </ul> <p data-bbox="333 435 995 517">If fluctuations occur frequently and this message is displayed often, contact the grid operator and request approval to change the operating parameters of the inverter.</p> <p data-bbox="333 528 938 580">If the grid operator gives his approval, discuss any changes to the operating parameters with Service (see Section 14, page 94).</p>
601	<p data-bbox="311 598 596 630"><b>⚠ QUALIFIED PERSON</b></p> <p data-bbox="288 646 392 670"><b>Grid fault</b></p> <p data-bbox="288 683 977 735">The inverter has detected an excessively high proportion of direct current in the grid current.</p> <p data-bbox="288 746 508 770"><b>Corrective measures:</b></p> <ul data-bbox="311 782 964 868" style="list-style-type: none"> <li data-bbox="311 782 736 805">• Check the grid connection for direct current.</li> <li data-bbox="311 817 964 868">• If this message is displayed frequently, contact the grid operator and check whether the monitoring threshold on the inverter can be raised.</li> </ul>
801	<p data-bbox="311 885 596 917"><b>⚠ QUALIFIED PERSON</b></p> <p data-bbox="288 933 960 957"><b>Waiting for grid voltage &gt; Grid failure &gt; Check AC circuit breaker</b></p> <p data-bbox="288 970 1006 1023">The AC cable is not correctly connected or the country data set is not correctly configured.</p> <p data-bbox="288 1034 508 1058"><b>Corrective measures:</b></p> <ul data-bbox="311 1069 990 1254" style="list-style-type: none"> <li data-bbox="311 1069 782 1093">• Make sure that the circuit breaker is switched on.</li> <li data-bbox="311 1104 930 1157">• Ensure that the AC cable is not damaged and that it is connected correctly.</li> <li data-bbox="311 1168 908 1192">• Ensure that the country data set has been configured correctly.</li> <li data-bbox="311 1203 990 1254">• Check whether the grid voltage at the connection point of the inverter is permanently in the permissible range.</li> </ul> <p data-bbox="333 1265 992 1375">If the grid voltage is outside the permissible range due to local grid conditions, contact the grid operator. The grid operator must agree with an adjustment of the voltage at the feed-in point or with a change of the monitored operating limits.</p> <p data-bbox="333 1386 975 1468">If the grid voltage is permanently within the permissible range and this message is still displayed, contact the Service (see Section 14, page 94).</p>

Event number	Message, cause and corrective measures
901	<p data-bbox="308 183 593 215"><b>⚠ QUALIFIED PERSON</b></p> <p data-bbox="285 231 666 263"><b>PE conn. missing &gt; Check connection</b></p> <p data-bbox="285 271 767 295">The grounding conductor is not correctly connected.</p> <p data-bbox="285 303 509 327"><b>Corrective measures:</b></p> <ul data-bbox="308 335 879 367" style="list-style-type: none"> <li>• Ensure that the grounding conductor is correctly connected.</li> </ul>
3401 to 3407	<p data-bbox="308 383 593 414"><b>⚠ QUALIFIED PERSON</b></p> <p data-bbox="285 430 700 462"><b>DC overvoltage &gt; Disconnect generator</b></p> <p data-bbox="285 470 823 494">Overvoltage at the DC input. This can destroy the inverter.</p> <p data-bbox="285 502 918 526">This message is signalized additionally by rapid flashing of the LEDs.</p> <p data-bbox="285 534 509 558"><b>Corrective measures:</b></p> <ul data-bbox="308 566 1002 869" style="list-style-type: none"> <li>• <b>Immediately</b> disconnect the inverter from all voltage sources (see Section 9, page 61).</li> <li>• Check whether the DC voltage is below the maximum input voltage of the inverter. If the DC voltage is below the maximum input voltage of the inverter, reconnect the DC connectors to the inverter.</li> <li>• If the DC voltage exceeds the maximum input voltage of the inverter, ensure that the PV array has been correctly rated or contact the installer of the PV array.</li> <li>• If this message is repeated frequently, contact the Service (see Section 14, page 94).</li> </ul>
3501	<p data-bbox="308 885 593 917"><b>⚠ QUALIFIED PERSON</b></p> <p data-bbox="285 933 660 965"><b>Insulation failure &gt; Check generator</b></p> <p data-bbox="285 973 800 997">The inverter has detected a ground fault in the PV array.</p> <p data-bbox="285 1005 509 1029"><b>Corrective measures:</b></p> <ul data-bbox="308 1037 957 1069" style="list-style-type: none"> <li>• Check the PV system for ground faults (see Section 11.3, page 81).</li> </ul>
3701	<p data-bbox="308 1085 593 1117"><b>⚠ QUALIFIED PERSON</b></p> <p data-bbox="285 1133 677 1165"><b>Resid.curr.too.high &gt; Check generator</b></p> <p data-bbox="285 1173 1008 1220">The inverter has detected a residual current due to temporary grounding of the PV array.</p> <p data-bbox="285 1228 509 1252"><b>Corrective measures:</b></p> <ul data-bbox="308 1260 957 1292" style="list-style-type: none"> <li>• Check the PV system for ground faults (see Section 11.3, page 81).</li> </ul>

Event number	Message, cause and corrective measures
3801 to 3805	<p data-bbox="311 183 593 215"><b>⚠ QUALIFIED PERSON</b></p> <p data-bbox="288 231 644 263"><b>DC overcurrent &gt; Check generator</b></p> <p data-bbox="288 271 980 295">Overcurrent at the DC input. The inverter briefly interrupts feed-in operation.</p> <p data-bbox="288 303 509 327"><b>Corrective measures:</b></p> <ul data-bbox="311 335 1002 391" style="list-style-type: none"> <li data-bbox="311 335 1002 391">• If this message is displayed frequently, ensure that the PV array has been correctly rated and wired.</li> </ul>
6002 to 6412	<p data-bbox="311 406 593 438"><b>⚠ QUALIFIED PERSON</b></p> <p data-bbox="288 454 655 486"><b>Self diagnosis &gt; Interference device</b></p> <p data-bbox="288 494 711 518">The cause must be determined by the Service.</p> <p data-bbox="288 526 509 550"><b>Corrective measures:</b></p> <ul data-bbox="311 558 767 582" style="list-style-type: none"> <li data-bbox="311 558 767 582">• Contact the Service (see Section 14, page 94).</li> </ul>
6502	<p data-bbox="311 606 593 638"><b>⚠ QUALIFIED PERSON</b></p> <p data-bbox="288 654 638 686"><b>Self-diagnosis &gt; Overtemperature</b></p> <p data-bbox="288 694 828 718">The inverter has switched off due to excessive temperature.</p> <p data-bbox="288 726 509 750"><b>Corrective measures:</b></p> <ul data-bbox="311 758 980 917" style="list-style-type: none"> <li data-bbox="311 758 980 813">• Clean the cooling fins on the rear of the enclosure and the air ducts on the top using a soft brush.</li> <li data-bbox="311 821 767 845">• Ensure that the inverter has sufficient ventilation.</li> <li data-bbox="311 853 968 877">• Ensure that the ambient temperature +40°C has not been exceeded.</li> <li data-bbox="311 885 918 909">• Ensure that the inverter is not exposed to direct solar irradiation.</li> </ul>
6512	<p data-bbox="288 933 756 965"><b>Minimum operating temperature not reached</b></p> <p data-bbox="288 965 946 1021">The inverter will only recommence grid feed-in once the temperature has reached at least -25°C.</p>
6603 to 6604	<p data-bbox="311 1037 593 1069"><b>⚠ QUALIFIED PERSON</b></p> <p data-bbox="288 1085 560 1117"><b>Self-diagnosis &gt; Overload</b></p> <p data-bbox="288 1125 711 1149">The cause must be determined by the Service.</p> <p data-bbox="288 1157 509 1181"><b>Corrective measures:</b></p> <ul data-bbox="311 1189 767 1212" style="list-style-type: none"> <li data-bbox="311 1189 767 1212">• Contact the Service (see Section 14, page 94).</li> </ul>

Event number	Message, cause and corrective measures
6701 to 6702	<p data-bbox="314 188 583 220"><b>⚠ QUALIFIED PERSON</b></p> <p data-bbox="292 236 555 263"><b>Communication disturbed</b></p> <p data-bbox="292 272 986 328">Error in the communication processor, the inverter continues feeding in, however. The cause must be determined by the Service.</p> <p data-bbox="292 336 508 363"><b>Corrective measures:</b></p> <ul data-bbox="311 371 910 427" style="list-style-type: none"> <li data-bbox="311 371 910 427">• If this message is displayed frequently, contact the Service (see Section 14, page 94).</li> </ul>
7102	<p data-bbox="314 443 583 475"><b>⚠ QUALIFIED PERSON</b></p> <p data-bbox="292 491 667 518"><b>Parameter file not found or defective</b></p> <p data-bbox="292 528 969 584">The parameter file was not found or is defective. The update failed. The inverter continues to feed in.</p> <p data-bbox="292 592 508 619"><b>Corrective measures:</b></p> <ul data-bbox="311 627 804 651" style="list-style-type: none"> <li data-bbox="311 627 804 651">• Copy the parameter file to the correct folder again.</li> </ul>
7105	<p data-bbox="314 667 583 699"><b>⚠ QUALIFIED PERSON</b></p> <p data-bbox="292 715 505 742"><b>Param. setting failed</b></p> <p data-bbox="292 751 992 807">Parameters could not be set using the memory card. The inverter continues to feed in.</p> <p data-bbox="292 815 508 842"><b>Corrective measures:</b></p> <ul data-bbox="311 850 804 906" style="list-style-type: none"> <li data-bbox="311 850 736 877">• Ensure that the parameters are set correctly.</li> <li data-bbox="311 885 804 906">• Ensure that the SMA Grid Guard code is available.</li> </ul>
7106	<p data-bbox="292 922 479 949"><b>Update file defect.</b></p> <p data-bbox="292 959 986 1015">The update file is defective. The update failed. The inverter continues to feed in.</p>
7110	<p data-bbox="292 1026 505 1053"><b>No update file found</b></p> <p data-bbox="292 1062 969 1118">No new update file was found on the SD memory card. The update failed. The inverter continues to feed in.</p>
7112	<b>Update file successfully copied</b>
7113	<b>The memory card is full or write-protected</b>
7201 to 7202	<b>Data storage not possible</b>
7303	<p data-bbox="314 1254 583 1286"><b>⚠ QUALIFIED PERSON</b></p> <p data-bbox="292 1302 538 1329"><b>Update main CPU failed</b></p> <p data-bbox="292 1339 706 1366">The cause must be determined by the Service.</p> <p data-bbox="292 1374 508 1401"><b>Corrective measures:</b></p> <ul data-bbox="311 1409 768 1439" style="list-style-type: none"> <li data-bbox="311 1409 768 1439">• Contact the Service (see Section 14, page 94).</li> </ul>

Event number	Message, cause and corrective measures
7320	<p><b>The device with serial number [xx] was successfully updated to firmware version [xxx].</b></p> <p>The firmware update was completed successfully.</p>
7330	<p><b>Condition test failed</b></p> <p>The testing of the update conditions was successful. The firmware update package is suitable for this inverter.</p>
7331	<p><b>Update transport started</b></p> <p>Update file is being copied.</p>
7332	<p><b>Update transport successful</b></p> <p>Update file was copied successfully to the inverter's internal memory.</p>
7333	<p><b> QUALIFIED PERSON</b></p> <p><b>Update transport failed</b></p> <p>Update file could not be copied to the inverter's internal memory. In the event of connection with the inverter via WLAN, a poor connection quality can be the cause.</p> <p><b>Corrective measures:</b></p> <ul style="list-style-type: none"> <li>• Retry update.</li> <li>• For WLAN connection: Improve the WLAN connection quality (e.g. via WLAN repeater) or establish connection with the inverter via Ethernet.</li> <li>• If this message is displayed again, contact the Service (see Section 14, page 94).</li> </ul>
7341	<p><b>Update Bootloader</b></p> <p>The inverter is performing a bootloader update.</p>
7342	<p><b> QUALIFIED PERSON</b></p> <p><b>Update Bootloader failed</b></p> <p>The bootloader update failed.</p> <p><b>Corrective measures:</b></p> <ul style="list-style-type: none"> <li>• Retry update.</li> <li>• If this message is displayed again, contact the Service (see Section 14, page 94).</li> </ul>

Event number	Message, cause and corrective measures
7347	<p data-bbox="311 185 596 220"><b>⚠ QUALIFIED PERSON</b></p> <p data-bbox="288 236 463 261"><b>Incompatible file</b></p> <p data-bbox="288 272 759 298">The configuration file is not suitable for this inverter.</p> <p data-bbox="288 309 508 335"><b>Corrective measures:</b></p> <ul data-bbox="311 341 952 399" style="list-style-type: none"> <li data-bbox="311 341 952 367">• Ensure that the selected configuration file is suitable for this inverter.</li> <li data-bbox="311 373 452 399">• Retry import.</li> </ul>
7348	<p data-bbox="311 416 596 451"><b>⚠ QUALIFIED PERSON</b></p> <p data-bbox="288 467 493 493"><b>Incorrect file format</b></p> <p data-bbox="288 504 885 529">The configuration file is not of the required format or is damaged.</p> <p data-bbox="288 541 508 566"><b>Corrective measures:</b></p> <ul data-bbox="311 572 997 660" style="list-style-type: none"> <li data-bbox="311 572 997 630">• Ensure that the selected configuration file is of the required format and is not damaged.</li> <li data-bbox="311 636 452 660">• Retry import.</li> </ul>
7349	<p data-bbox="288 678 717 703"><b>Incorrect login rights for configuration file</b></p> <p data-bbox="288 715 986 772">The user group logged in does not have the user rights necessary to be able to import a configuration.</p> <p data-bbox="288 778 508 804"><b>Corrective measures:</b></p> <ul data-bbox="311 810 620 868" style="list-style-type: none"> <li data-bbox="311 810 508 836">• Log in as <b>Installer</b>.</li> <li data-bbox="311 842 620 868">• Import configuration file again.</li> </ul>
7350	<p data-bbox="288 885 721 911"><b>Transfer of a configuration file has started</b></p> <p data-bbox="288 922 669 948">The configuration file is being transferred.</p>
7351	<p data-bbox="288 962 445 987"><b>Update WLAN</b></p> <p data-bbox="288 999 687 1024">The inverter is updating the WLAN module.</p>
7352	<p data-bbox="288 1038 617 1064"><b>Update of WLAN not successful</b></p> <p data-bbox="288 1075 658 1101">The update of the WLAN module failed.</p> <p data-bbox="288 1112 508 1137"><b>Corrective measures:</b></p> <ul data-bbox="311 1144 986 1232" style="list-style-type: none"> <li data-bbox="311 1144 460 1169">• Retry update.</li> <li data-bbox="311 1176 986 1232">• If this message is displayed again, contact the Service (see Section 14, page 94).</li> </ul>
7353	<p data-bbox="288 1246 580 1272"><b>Update time zone database</b></p> <p data-bbox="288 1283 732 1308">The inverter is updating the time zone database.</p>

Event number	Message, cause and corrective measures
7354	<p><b>⚠ QUALIFIED PERSON</b></p> <p><b>Update of time zone database not successful</b> The update of the time zone database failed.</p> <p><b>Corrective measures:</b></p> <ul style="list-style-type: none"> <li>• Retry update.</li> <li>• If this message is displayed again, contact the Service (see Section 14, page 94).</li> </ul>
7355	<p><b>Update WebUI</b> The inverter is updating the inverter user interface.</p>
7356	<p><b>⚠ QUALIFIED PERSON</b></p> <p><b>Update of the WebUI not successful</b> The update of the inverter user interface failed.</p> <p><b>Corrective measures:</b></p> <ul style="list-style-type: none"> <li>• Retry update.</li> <li>• If this message is displayed again, contact the Service (see Section 14, page 94).</li> </ul>
7500 to 7501	<p><b>⚠ QUALIFIED PERSON</b></p> <p><b>Fan fault &gt; Check inverter electronic and fan</b></p>
7619	<p><b>⚠ QUALIFIED PERSON</b></p> <p><b>Communication fault with meter unit &gt; Check communication to meter</b> The inverter is not receiving any data from the energy meter.</p> <p><b>Corrective measures:</b></p> <ul style="list-style-type: none"> <li>• Ensure that the energy meter is correctly integrated into the same network as the inverter (see energy meter manual).</li> <li>• For WLAN connection: Improve the WLAN connection quality (e.g. via WLAN repeater) or connect the inverter with the DHCP server (router) via Ethernet.</li> </ul>
7702	<p><b>⚠ QUALIFIED PERSON</b></p> <p><b>Interference device</b> The cause must be determined by the Service.</p> <p><b>Corrective measures:</b></p> <ul style="list-style-type: none"> <li>• Contact the Service (see Section 14, page 94).</li> </ul>



Event number	Message, cause and corrective measures
8003	<p data-bbox="311 188 595 220"><b>⚠ QUALIFIED PERSON</b></p> <p data-bbox="288 236 595 263"><b>Active power limited derating</b></p> <p data-bbox="288 272 1003 327">The inverter has reduced its power output for more than ten minutes due to excessive temperature.</p> <p data-bbox="288 336 508 360"><b>Corrective measures:</b></p> <ul data-bbox="311 370 981 526" style="list-style-type: none"> <li data-bbox="311 370 981 424">• Clean the cooling fins on the rear of the enclosure and the air ducts on the top using a soft brush.</li> <li data-bbox="311 434 770 458">• Ensure that the inverter has sufficient ventilation.</li> <li data-bbox="311 467 966 491">• Ensure that the ambient temperature +40 °C has not been exceeded.</li> <li data-bbox="311 501 919 526">• Ensure that the inverter is not exposed to direct solar irradiation.</li> </ul>
8101 to 8104	<p data-bbox="311 547 595 579"><b>⚠ QUALIFIED PERSON</b></p> <p data-bbox="288 595 555 619"><b>Communication disturbed</b></p> <p data-bbox="288 628 708 655">The cause must be determined by the Service.</p> <p data-bbox="288 665 508 689"><b>Corrective measures:</b></p> <ul data-bbox="311 699 768 726" style="list-style-type: none"> <li data-bbox="311 699 768 726">• Contact the Service (see Section 14, page 94).</li> </ul>
9002	<p data-bbox="311 738 595 770"><b>⚠ QUALIFIED PERSON</b></p> <p data-bbox="288 786 598 810"><b>SMA Grid Guard code invalid</b></p> <p data-bbox="288 820 1006 874">The SMA Grid Guard code entered is incorrect. The operating parameters are still protected and cannot be changed.</p> <p data-bbox="288 884 508 908"><b>Corrective measures:</b></p> <ul data-bbox="311 917 710 944" style="list-style-type: none"> <li data-bbox="311 917 710 944">• Enter the correct SMA Grid Guard code.</li> </ul>
9003	<p data-bbox="288 962 527 986"><b>Grid parameter locked</b></p> <p data-bbox="288 995 1006 1078">Changes to the grid parameters are now blocked. In order to be able to make changes to the grid parameters, from now on you must log in using the SMA Grid Guard code.</p>
9005	<p data-bbox="311 1098 595 1129"><b>⚠ QUALIFIED PERSON</b></p> <p data-bbox="288 1145 925 1169"><b>Changing of grid parameters not possible &gt; Ensure DC supply</b></p> <p data-bbox="288 1179 664 1206">This error can have the following causes:</p> <ul data-bbox="311 1216 956 1276" style="list-style-type: none"> <li data-bbox="311 1216 751 1243">• The parameters to be changed are protected.</li> <li data-bbox="311 1252 956 1276">• The DC voltage at the DC input is not sufficient to run the main CPU.</li> </ul> <p data-bbox="288 1286 508 1310"><b>Corrective measures:</b></p> <ul data-bbox="311 1319 934 1412" style="list-style-type: none"> <li data-bbox="311 1319 639 1347">• Enter the SMA Grid Guard code.</li> <li data-bbox="311 1356 934 1412">• Ensure that at least the DC start voltage is available (green LED is flashing, pulsing or glowing).</li> </ul>

Event number	Message, cause and corrective measures
9007	<p><b>⚠ QUALIFIED PERSON</b></p> <p><b>Abort self-test</b> The self-test (Italy only) was terminated.</p> <p><b>Corrective measures:</b></p> <ul style="list-style-type: none"> <li>• Ensure that the AC connection is correct.</li> <li>• Restart the self-test.</li> </ul>
10108	<b>Time adjusted / old time</b>
10109	<b>Time adjusted / new time</b>
10110	<p><b>⚠ QUALIFIED PERSON</b></p> <p><b>Time synchronization failed:  tn0 </b> No time information could be called up from the set NTP server.</p> <p><b>Corrective measures:</b></p> <ul style="list-style-type: none"> <li>• Ensure that the NTP server was configured correctly.</li> <li>• Ensure that the inverter is integrated into a local network with Internet connection.</li> </ul>
10118	<p><b>Parameter upload complete</b> The configuration file was loaded successfully.</p>
10248	<p><b>⚠ QUALIFIED PERSON</b></p> <p><b>[Interface]: network busy</b> The network is busy. Data exchange between the devices is not at an optimum and is greatly delayed.</p> <p><b>Corrective measures:</b></p> <ul style="list-style-type: none"> <li>• Increase the query intervals.</li> <li>• If necessary, reduce the number of devices in the network.</li> </ul>
10249	<p><b>⚠ QUALIFIED PERSON</b></p> <p><b>[Interface]: network overloaded</b> The network is overloaded. There is no data exchange between the devices.</p> <p><b>Corrective measures:</b></p> <ul style="list-style-type: none"> <li>• Reduce the number of devices in the network.</li> <li>• If necessary, increase the data query intervals.</li> </ul>

Event number	Message, cause and corrective measures
10250	<p data-bbox="311 188 595 220"><b>⚠ QUALIFIED PERSON</b></p> <p data-bbox="288 236 722 263"><b>[Interface]: package error rate [ok / high]</b></p> <p data-bbox="288 271 1005 354">The package error rate has changed. If the package error rate is high, the network is overloaded or the connection to the network switch or DHCP server (router) is disturbed.</p> <p data-bbox="288 363 837 391"><b>Corrective measures if the package error rate is high:</b></p> <ul data-bbox="311 399 1008 550" style="list-style-type: none"> <li data-bbox="311 399 1008 481">• Ensure that with an Ethernet connection, the network cable and the network connector are not damaged and that the network connectors are correctly plugged.</li> <li data-bbox="311 491 759 518">• If necessary, increase the data query intervals.</li> <li data-bbox="311 528 864 550">• If necessary, reduce the number of devices in the network.</li> </ul>
10251	<p data-bbox="288 566 968 622"><b>[Interface]: communication status goes to [OK / Warning / Error / Not connected]</b></p> <p data-bbox="288 630 983 683">The communication status to the network switch or DHCP server (router) has changed. An additional error message may be displayed.</p>
10252	<p data-bbox="311 702 595 734"><b>⚠ QUALIFIED PERSON</b></p> <p data-bbox="288 750 669 777"><b>[Interface]: communication disrupted</b></p> <p data-bbox="288 785 685 812">There is no valid signal on the network line.</p> <p data-bbox="288 821 509 849"><b>Corrective measures:</b></p> <ul data-bbox="311 857 1008 1005" style="list-style-type: none"> <li data-bbox="311 857 1008 941">• Ensure that with an Ethernet connection, the network cable and the network connector are not damaged and that the network connectors are correctly plugged.</li> <li data-bbox="311 951 946 1005">• Ensure that the DHCP server (router) and any network switches are signaling correct operation.</li> </ul>
10253	<p data-bbox="311 1021 595 1053"><b>⚠ QUALIFIED PERSON</b></p> <p data-bbox="288 1069 890 1096"><b>[Interface]: connection speed goes to [100 Mbit / 10 Mbit]</b></p> <p data-bbox="288 1104 1002 1187">The data transfer rate has changed. The cause for the status [10 Mbit] can be a defective plug, a defective cable or the pulling or plugging of the network connector.</p> <p data-bbox="288 1197 752 1224"><b>Corrective measures if the status is [10 Mbit]:</b></p> <ul data-bbox="311 1232 1008 1378" style="list-style-type: none"> <li data-bbox="311 1232 1008 1315">• Ensure that with an Ethernet connection, the network cable and the network connector are not damaged and that the network connectors are correctly plugged.</li> <li data-bbox="311 1324 946 1378">• Ensure that the DHCP server (router) and any network switches are signaling correct operation.</li> </ul>

Event number	Message, cause and corrective measures
10254	<p data-bbox="291 183 593 215"><b>⚠ QUALIFIED PERSON</b></p> <p data-bbox="291 231 756 263"><b>[Interface]: duplex mode goes to [Full / Half]</b></p> <p data-bbox="291 271 1002 359">The duplex mode (data transfer mode) has changed. The cause for the status [Half] can be a defective plug, a defective cable or the pulling or plugging of the network connector.</p> <p data-bbox="291 367 716 391"><b>Corrective measures if the status is [Half]:</b></p> <ul data-bbox="308 399 1008 542" style="list-style-type: none"> <li data-bbox="308 399 1008 486">• Ensure that with an Ethernet connection, the network cable and the network connector are not damaged and that the network connectors are correctly plugged.</li> <li data-bbox="308 486 1008 542">• Ensure that the DHCP server (router) and any network switches are signaling correct operation.</li> </ul>
10255	<p data-bbox="291 558 593 590"><b>⚠ QUALIFIED PERSON</b></p> <p data-bbox="291 606 599 638"><b>[Interface]: Network load OK</b></p> <p data-bbox="291 646 901 678">The network load has returned to a normal range after being busy.</p>
10282	<p data-bbox="291 686 705 718"><b>[User group]-Login via [protocol] locked</b></p> <p data-bbox="291 726 968 805">After several incorrect login attempts, login has been blocked for a limited time. In this case, the User login will be blocked for 15 minutes, the Grid Guard login for 12 hours.</p> <p data-bbox="291 813 509 837"><b>Corrective measures:</b></p> <ul data-bbox="308 845 862 869" style="list-style-type: none"> <li data-bbox="308 845 862 869">• Wait until the given time has expired and then retry login.</li> </ul>
10283	<p data-bbox="291 885 593 917"><b>⚠ QUALIFIED PERSON</b></p> <p data-bbox="291 933 509 965"><b>WLAN module faulty</b></p> <p data-bbox="291 973 812 997">The WLAN module integrated in the inverter is defective.</p> <p data-bbox="291 1005 509 1029"><b>Corrective measures:</b></p> <ul data-bbox="308 1037 767 1069" style="list-style-type: none"> <li data-bbox="308 1037 767 1069">• Contact the Service (see Section 14, page 94).</li> </ul>

Event number	Message, cause and corrective measures
10284	<p data-bbox="308 188 599 220"><b>⚠ QUALIFIED PERSON</b></p> <p data-bbox="285 236 610 268"><b>No WLAN connection possible</b></p> <p data-bbox="285 276 991 323">The inverter does not currently have a WLAN connection to the selected network.</p> <p data-bbox="285 339 509 363"><b>Corrective measures:</b></p> <ul data-bbox="308 371 1002 582" style="list-style-type: none"> <li data-bbox="308 371 1002 451">• Ensure that the SSID, the WLAN password and the encryption method have been entered correctly. The encryption method is specified by your WLAN router or WLAN Access Point and can be changed there.</li> <li data-bbox="308 467 1002 515">• Ensure that the WLAN router or WLAN Access Point is in range and is signaling correct operation.</li> <li data-bbox="308 531 1002 582">• If this message is displayed often, improve the WLAN connection by using a WLAN repeater.</li> </ul>
10285	<p data-bbox="285 598 599 622"><b>WLAN connection established</b></p> <p data-bbox="285 630 890 654">Connection to the selected WLAN network has been established.</p>
10286	<p data-bbox="308 670 599 702"><b>⚠ QUALIFIED PERSON</b></p> <p data-bbox="285 718 520 742"><b>WLAN connection lost</b></p> <p data-bbox="285 758 868 782">The inverter has lost WLAN connection to the selected network.</p> <p data-bbox="285 798 509 821"><b>Corrective measures:</b></p> <ul data-bbox="308 829 1002 981" style="list-style-type: none"> <li data-bbox="308 829 1002 853">• Ensure that the WLAN router or WLAN Access Point is still active.</li> <li data-bbox="308 861 1002 917">• Ensure that the WLAN router or WLAN Access Point is in range and is signaling correct operation.</li> <li data-bbox="308 925 1002 981">• If this message is displayed often, improve the WLAN connection by using a WLAN repeater.</li> </ul>
10339	<p data-bbox="285 997 509 1021"><b>Webconnect enabled</b></p> <p data-bbox="285 1029 711 1053">The Webconnect function has been activated.</p>
10340	<p data-bbox="285 1069 509 1093"><b>Webconnect disabled</b></p> <p data-bbox="285 1101 733 1125">The Webconnect function has been deactivated.</p>
10341	<p data-bbox="285 1141 632 1165"><b>Webconnect error: no connection</b></p> <p data-bbox="285 1173 655 1204">No connection to Sunny Portal possible.</p> <p data-bbox="285 1212 509 1236"><b>Corrective measures:</b></p> <ul data-bbox="308 1244 1002 1345" style="list-style-type: none"> <li data-bbox="308 1244 1002 1268">• Ensure that the Internet connection is working properly.</li> <li data-bbox="308 1276 1002 1300">• Ensure that the Webconnect function is activated.</li> <li data-bbox="308 1308 1002 1345">• Ensure that the network cable at the inverter is correctly connected.</li> </ul>

Event number	Message, cause and corrective measures
10343	<p><b>Webconnect error: Default gateway not configured</b> The standard gateway was not configured.</p> <p><b>Corrective measures:</b></p> <ul style="list-style-type: none"> <li>• Configure the standard gateway.</li> </ul>
10344	<p><b>Webconnect error: DNS server not configured</b> DNS server was not configured.</p> <p><b>Corrective measures:</b></p> <ul style="list-style-type: none"> <li>• Configure DNS server.</li> </ul>
10345	<p><b>Webconnect error: No reply to DNS request [xx]</b> DNS server not available</p> <p><b>Corrective measures:</b></p> <ul style="list-style-type: none"> <li>• Ensure that the address of the DNS server has been entered correctly.</li> <li>• Ensure that the network cable at the inverter is correctly connected.</li> </ul>
10346	<p><b>Webconnect error: Unknown SIP proxy [xx]</b> SIP-Proxy not available.</p> <p><b>Corrective measures:</b></p> <ul style="list-style-type: none"> <li>• Ensure that the network cable at the inverter is correctly connected.</li> </ul>
10347	<p><b>Webconnect error: Unknown STUN server [xx]</b> STUN server not available.</p> <p><b>Corrective measures:</b></p> <ul style="list-style-type: none"> <li>• Ensure that the network cable at the inverter is correctly connected.</li> </ul>
10348	<p><b>Webconnect error: No reply to request to STUN server</b> STUN server not available.</p> <p><b>Corrective measures:</b></p> <ul style="list-style-type: none"> <li>• Ensure that the network cable at the inverter is correctly connected.</li> <li>• Check the configuration of the router.</li> </ul>
10349	<p><b>Webconnect error: No reply to SIP option packs</b> SIP server not available.</p> <p><b>Corrective measures:</b></p> <ul style="list-style-type: none"> <li>• Check the configuration of the router.</li> </ul>
10350	<p><b>Webconnect error: Registration rejected by SIP registrar</b> The inverter is not registered in Sunny Portal.</p> <p><b>Corrective measures:</b></p> <ul style="list-style-type: none"> <li>• Contact the Service (see Section 14, page 94).</li> </ul>

Event number	Message, cause and corrective measures
10351	<p><b>Webconnect error: Unknown SIP registrar [xx]</b> SIP Registrar not available.</p> <p><b>Corrective measures:</b></p> <ul style="list-style-type: none"> <li>• Ensure that the network cable at the inverter is correctly connected.</li> <li>• Check the configuration of the router.</li> </ul>
10352	<p><b>Webconnect error: Faulty communication</b> No connection to Sunny Portal possible.</p> <p><b>Corrective measures:</b></p> <ul style="list-style-type: none"> <li>• Ensure that the Internet connection is working properly.</li> <li>• Ensure that the Webconnect function is activated.</li> <li>• Ensure that the network cable at the inverter is correctly connected.</li> </ul>
10353	<p><b>Webconnect error: registration of the SIP registry has not responded</b> SIP Registrar not fully available.</p> <p><b>Corrective measures:</b></p> <ul style="list-style-type: none"> <li>• Ensure that the network cable at the inverter is correctly connected.</li> <li>• Check the configuration of the router.</li> </ul>
10502	<p><b>Active power limited AC frequency</b> The inverter has reduced its power due to a too-high power frequency to ensure grid stability.</p> <p><b>Corrective measures:</b></p> <ul style="list-style-type: none"> <li>• If possible, check the power frequency and observe how often fluctuations occur. If fluctuations occur frequently and this message is displayed often, contact the grid operator and request approval to change the operating parameters of the inverter. If the grid operator gives his approval, discuss any changes to the operating parameters with Service (see Section 14, page 94).</li> </ul>
10901	<p><b>Start self-test [xx]</b> The self-test is running.</p>
10902	<p><b>Uac RPro [xxx] V</b> Preliminary result of the self-test</p>
10903	<p><b>Uac Max [xxx] V</b> Preliminary result of the self-test</p>
10904	<p><b>Uac Min [xxx] V</b> Preliminary result of the self-test</p>
10905	<p><b>Uac Min Fast [xxx] V</b> Preliminary result of the self-test</p>

Event number	Message, cause and corrective measures
10906	<b>Fac SwMax [xxx] Hz</b> Preliminary result of the self-test
10907	<b>Fac SwMin [xxx] Hz</b> Preliminary result of the self-test
10908	<b>Fac Max [xxx] Hz</b> Preliminary result of the self-test
10909	<b>Fac Min [xxx] Hz</b> Preliminary result of the self-test
10910	<b>Disconn. threshold [xxx] [xx]</b> Preliminary result of the self-test
10911	<b>Stand. Val. [xxx] [xx]</b> Preliminary result of the self-test
10912	<b>Disconn. time [xx] s</b> Preliminary result of the self-test
27103	<b>Set parameter</b> The parameter changes are being adopted.
27104	<b>Parameters set successfully</b> The parameter changes were successfully adopted.
27107	<b>Update file OK</b> The update file found is valid.
27301	<b>Update communication</b> The inverter is updating the communication component.
27302	<b>Update main CPU</b> The inverter is updating the inverter component.
27312	<b>Update completed</b> The inverter has successfully completed the update.
29001	<b>Inst. code valid</b> The entered Grid Guard code is valid. Protected parameters have now been unlocked and you can adjust the parameters. The parameters will be automatically locked again after ten feed-in hours.
29004	<b>Grid parameters unchanged</b> Changing the grid parameters is not possible.



## 11.3 Checking the PV System for Ground Faults

### QUALIFIED PERSON

A ground fault may be present if the inverter beeps, the red LED lights up and the event numbers 3501, 3601 or 3701 are being displayed in the **Results** menu on the inverter user interface. The electrical insulation from the PV system to ground is defective or insufficient.

### DANGER

#### **Danger to life due to electric shock when touching live system components in case of a ground fault**

If a ground fault occurs, parts of the system may still be live. Touching live parts and cables results in death or lethal injuries due to electric shock.

- Disconnect the product from voltage sources and make sure it cannot be reconnected before working on the device.
- Touch the cables of the PV array on the insulation only.
- Do not touch any parts of the substructure or frame of the PV array.
- Do not connect PV strings with ground faults to the inverter.

### NOTICE

#### **Destruction of the measuring device due to overvoltage**

- Only use measuring devices with a DC input voltage range of 1000 V or higher.

#### **Procedure:**

In order to check the PV system for ground faults, perform the following actions in the prescribed order. The exact procedure is described in the following sections.

- Check the PV system for ground faults by measuring the voltage.
- If the voltage measurement was not successful, check the PV system via insulation resistance measurement for ground faults.

#### **Test by Measuring the Voltage**

Proceed as follows to check each string in the PV system for ground faults.

#### **Procedure:**

1.

### DANGER

#### **Danger to life due to high voltages**

- Disconnect the inverter from all voltage sources (see Section 9, page 61).

2. Measure the voltages:

- Measure the voltage between the positive terminal and the ground potential (PE).
- Measure the voltage between the negative terminal and the ground potential (PE).

- Measure the voltage between the positive and negative terminals.  
If the following results are present at the same time, there is a ground fault in the PV system:
  - ☑ All measured voltages are stable.
  - ☑ The sum of the two voltages to ground potential is approximately equal to the voltage between the positive and negative terminals.
- 3. If a ground fault is present, determine the location of the ground fault via the ratio of the two measured voltages and eliminate the ground fault.
- 4. If a definite ground fault cannot be measured and the message is still displayed, measure the insulation resistance.
- 5. Reconnect the strings without ground faults to the inverter and recommission the inverter (see inverter installation inverter).

### Location of the ground fault

The example shows a ground fault between the second and third PV module.

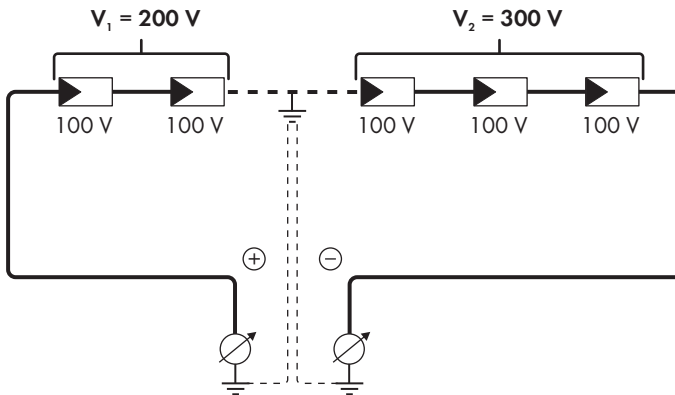

## Test by Measuring the Insulation Resistance

If the voltage measurement does not provide sufficient evidence of a ground fault, the insulation resistance measurement can provide more exact results.

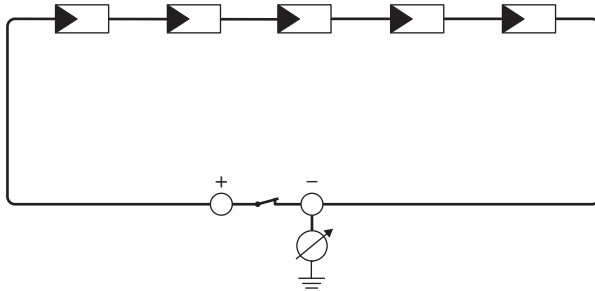

Figure 14: Schematic diagram of the measurement

### **i** Calculating the insulation resistance

The expected total resistance of the PV system or of an individual string can be calculated using the following formula:

$$\frac{1}{R_{\text{total}}} = \frac{1}{R_1} + \frac{1}{R_2} + \frac{1}{R_3} + \dots$$

The exact insulation resistance of a PV module can be obtained from the module manufacturer or the datasheet.

For the resistance of a PV module an average value can be assumed: for thin-film PV modules approximately 40 MOhm and for polycrystalline and monocrystalline PV modules approximately 50 MOhm per PV module (for further information on calculating the insulation resistance see the Technical Information "Insulation Resistance (Riso) of Non-Galvanically Isolated PV Systems" at [www.SMA-Solar.com](http://www.SMA-Solar.com)).

### Required devices:

- Suitable device for safe disconnection and short-circuiting
- Measuring device for insulation resistance

### **i** Device required for safe disconnection and short-circuiting of the PV array

The insulation resistance can only be measured with a suitable device for safe disconnection and short-circuiting of the PV array. If no suitable device is available, the insulation measurement must not be carried out.

### Procedure:

1. Calculate the expected insulation resistance per string.

2.

**! DANGER**

#### **Danger to life due to high voltages**

- Disconnect the inverter from all voltage sources (see Section 9, page 61).

3. Install the short circuit device.
4. Connect the measuring device for insulation resistance.
5. Short-circuit the first string.
6. Set the test voltage. The test voltage should be as close as possible to the maximum system voltage of the PV modules but must not exceed it (see datasheet of the PV modules).
7. Measure the insulation resistance.
8. Eliminate the short circuit.
9. Measure the remaining strings in the same manner.
  - If the insulation resistance of a string deviates considerably from the theoretically calculated value, there is a ground fault present in that string.
10. Reconnect to the inverter only those strings from which the ground fault has been eliminated.
11. Reconnect all other strings to the inverter.
12. Recommission the inverter.
13. If the inverter still displays an insulation error, contact the Service (see Section 14, page 94). The PV modules might not be suitable for the inverter in the present quantity.

## 12 Decommissioning the Inverter

### ⚠ QUALIFIED PERSON

To decommission the inverter completely upon completion of its service life, proceed as described in this Section.

### ⚠ CAUTION

#### Risk of injury due to weight of product

Injuries may result if the product is lifted incorrectly or dropped while being transported or when attaching it to or removing it from the wall mounting bracket.

- Transport and lift the product carefully. Take the weight of the product into account.
- Wear suitable personal protective equipment for all work on the product.

#### Procedure:

1.

### ⚠ DANGER

#### Danger to life due to high voltages

- Disconnect the inverter from all voltage sources (see Section 9, page 61).

2.

### ⚠ CAUTION

#### Risk of burns due to hot enclosure parts

- Wait 30 minutes for the enclosure to cool down.

3. Unscrew the RS485 plug and pull it out of the jack.

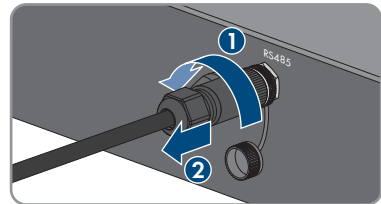

4. Screw the protective cap onto the RS485 jack.

5. Unscrew the swivel nut from the threaded sleeve for the network cable.

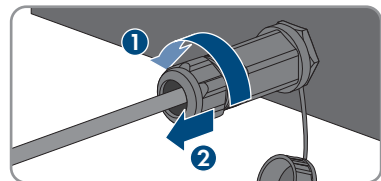

6. Unscrew and remove the threaded sleeve from the network port thread on the inverter.

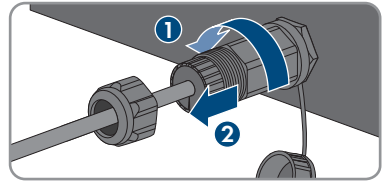

7. Release the network cable plug and pull it out of the jack on the inverter.

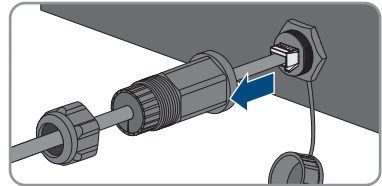

8. Take the cable support sleeve out of the threaded sleeve and remove the network cable from the cable support sleeve.

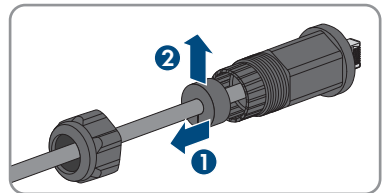

9. Lead the network cable out of the threaded sleeve and the swivel nut.

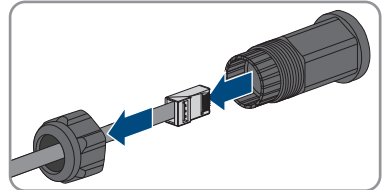

10. Screw the protective cap onto the network port.

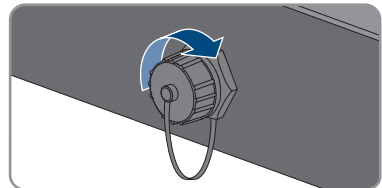

11. Unscrew and remove the antenna.

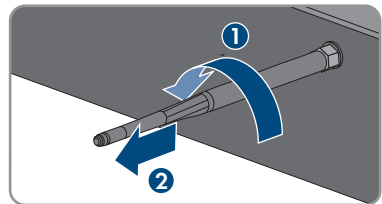

12. If there is a protective cap available, plug the protective cap onto the jack for connecting the antenna.

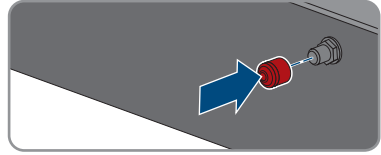

13. If an additional grounding or an equipotential bonding is connected to the inverter, remove the pan head screw M5x12 using a Torx screwdriver (TX 25) and remove the grounding cable.

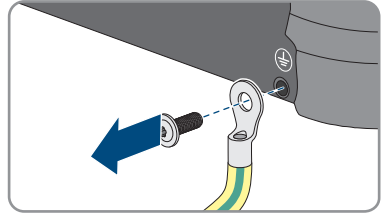

14. Using a Torx screwdriver (TX 25), unscrew the left- and right-hand pan head screws M5x12 used to secure the inverter to the wall mounting bracket.

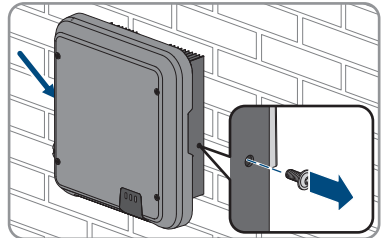

15. Remove the inverter by lifting it vertically up and off the wall mounting bracket.

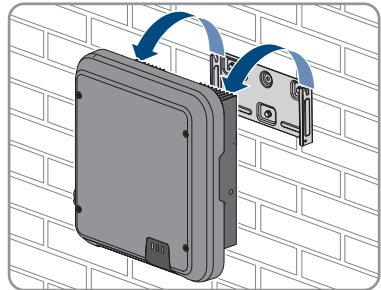

16. Unscrew the screws for fastening the wall mounting bracket and remove the wall mounting bracket.

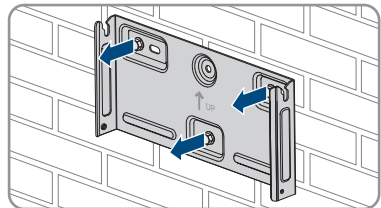

17. If the inverter is to be stored or shipped, pack the inverter, the AC connector, the DC connector, the RJ45 protective sleeve, the antenna and the wall mounting bracket. Use the original packaging or packaging that is suitable for the weight and dimensions of the inverter.
18. Dispose of the inverter in accordance with the locally applicable disposal regulations for electronic waste.

## 13 Technical Data

### 13.1 DC/AC

#### 13.1.1 Sunny Boy 3.0 / 3.6 / 4.0

##### DC Input

	SB3.0-1AV-41	SB3.6-1AV-41	SB4.0-1AV-41
Maximum PV array power	5500 Wp	5500 Wp	7500 Wp
Maximum input voltage	600 V	600 V	600 V
MPP voltage range	125 V to 500 V	125 V to 500 V	125 V to 500 V
Rated input voltage	365 V	365 V	365 V
Minimum input voltage	100 V	100 V	100 V
Initial input voltage	125 V	125 V	125 V
Maximum input current, input A	15 A	15 A	15 A
Maximum input current, input B	15 A	15 A	15 A
Maximum input current per string, input A	15 A	15 A	15 A
Maximum input current per string, input B	15 A	15 A	15 A
Maximum short-circuit current, input A*	20 A	20 A	20 A
Maximum short-circuit current, input B*	20 A	20 A	20 A
Maximum reverse current from the inverter in the system for max. 1 ms	0 A	0 A	0 A
Number of independent MPP inputs	2	2	2
Strings per MPP input	2	2	2
Overvoltage category in accordance with IEC 60664-1	II	II	II

\* In accordance with IEC 62109-2: ISC PV



## AC Output

	SB3.0-1AV-41	SB3.6-1AV-41	SB4.0-1AV-41
Rated power at 230 V, 50 Hz	3000 W	3680 W	4000 W
Maximum apparent AC power at $\cos \varphi = 1$	3000 VA	3680 VA	4000 VA
Rated grid voltage	230 V	230 V	230 V
Nominal AC voltage	220 V / 230 V / 240 V	220 V / 230 V / 240 V	220 V / 230 V / 240 V
AC voltage range*	180 V to 280 V	180 V to 280 V	180 V to 280 V
Nominal AC current at 220 V	13.7 A	16 A	18.2 A
Nominal AC current at 230 V	13.1 A	16 A	17.4 A
Nominal AC current at 240 V	12.5 A	15.4 A	16.7 A
Maximum output current	13.7 A	16 A	18.2 A
Total harmonic distortion of the output current with total harmonic distortion of the AC voltage <2%, and AC power >50% of the rated power	≤3 %	≤3 %	≤3 %
Maximum output current under fault conditions	29 A	29 A	29 A
Inrush current	< 20% of the nominal AC current for a maximum of 10 ms	< 20% of the nominal AC current for a maximum of 10 ms	< 20% of the nominal AC current for a maximum of 10 ms
Rated power frequency	50 Hz	50 Hz	50 Hz
AC power frequency*	50 Hz / 60 Hz	50 Hz / 60 Hz	50 Hz / 60 Hz
Operating range at AC power frequency 50 Hz	45 Hz to 55 Hz	45 Hz to 55 Hz	45 Hz to 55 Hz
Operating range at AC power frequency 60 Hz	55 Hz to 65 Hz	55 Hz to 65 Hz	55 Hz to 65 Hz

	SB3.0-1AV-41	SB3.6-1AV-41	SB4.0-1AV-41
Power factor at rated power	1	1	1
Displacement power factor $\cos \varphi$ , adjustable	0.8 overexcited to 0.8 underexcited	0.8 overexcited to 0.8 underexcited	0.8 overexcited to 1 to 0.8 underexcited
Feed-in phases	1	1	1
Phase connection	1	1	1
Overvoltage category in accordance with IEC 60664-1	III	III	III

\* Depending on the configured country data set

## Efficiency

	SB3.0-1AV-41	SB3.6-1AV-41	SB4.0-1AV-41
Maximum efficiency, $\eta_{\max}$	97.0 %	97.0 %	97.0 %
European weighted efficiency, $\eta_{\text{EU}}$	96.4 %	96.5 %	96.5 %

## 13.1.2 Sunny Boy 5.0 / 6.0

### DC Input

	SB5.0-1AV-41	SB6.0-1AV-41
Maximum PV array power	7500 W <sub>p</sub>	9000 W <sub>p</sub>
Maximum input voltage	600 V	600 V
MPP voltage range	125 V to 500 V	125 V to 500 V
Rated input voltage	365 V	365 V
Minimum input voltage	100 V	100 V
Initial input voltage	125 V	125 V
Maximum input current, input A	15 A	15 A
Maximum input current, input B	15 A	15 A
Maximum input current per string, input A	15 A	15 A
Maximum input current per string, input B	15 A	15 A
Maximum short-circuit current, input A*	20 A	20 A

	<b>SB5.0-1AV-41</b>	<b>SB6.0-1AV-41</b>
Maximum short-circuit current, input B*	20 A	20 A
Maximum reverse current from the inverter in the system for max. 1 ms	0 A	0 A
Number of independent MPP inputs	2	2
Strings per MPP input	2	2
Overvoltage category in accordance with IEC 60664-1	II	II

\* In accordance with IEC 62109-2: ISC PV

## AC Output

	<b>SB5.0-1AV-41</b>	<b>SB6.0-1AV-41</b>
Rated power at 230 V, 50 Hz*	5000 W	6000 W
Maximum apparent AC power at $\cos \varphi = 1^{**}$	5000 VA	6000 VA
Rated grid voltage	230 V	230 V
Nominal AC voltage	220 V / 230 V / 240 V	220 V / 230 V / 240 V
AC voltage range***	180 V to 280 V	180 V to 280 V
Nominal AC current at 220 V	22.8 A	26.1 A
Nominal AC current at 230 V	22 A	26.1 A
Nominal AC current at 240 V	21 A	25 A
Maximum output current****	22.8 A	26.1 A
Total harmonic distortion of the output current with total harmonic distortion of the AC voltage <2%, and AC power >50% of the rated power	≤3 %	≤3 %
Maximum output current under fault conditions	29 A	29 A
Inrush current	< 20% of the nominal AC current for a maximum of 10 ms	< 20% of the nominal AC current for a maximum of 10 ms
Rated power frequency	50 Hz	50 Hz
AC power frequency***	50 Hz / 60 Hz	50 Hz / 60 Hz
Operating range at AC power frequency 50 Hz	45 Hz to 55 Hz	45 Hz to 55 Hz
Operating range at AC power frequency 60 Hz	55 Hz to 65 Hz	55 Hz to 65 Hz

	SB5.0-1AV-41	SB6.0-1AV-41
Power factor at rated power	1	1
Displacement power factor $\cos \varphi$ , adjustable	0.8 overexcited to 1 to 0.8 underexcited	0.8 overexcited to 0.8 underexcited
Feed-in phases	1	1
Phase connection	1	1
Oversoltage category in accordance with IEC 60664-1	III	III

\* According to VDE-AR-N 4105, the rated power at 230 V, 50 Hz of the SB5.0-1AV-41 is 4600 W

\*\* According to VDE-AR-N 4105, the rated power at 230 V, 50 Hz of the SB5.0-1AV-41 is 4600 VA

\*\*\* Depending on the configured country data set

\*\*\*\* According to AS 4777, the maximum output current is 21.7 A

## Efficiency

	SB5.0-1AV-41	SB6.0-1AV-41
Maximum efficiency, $\eta_{\max}$	97.0 %	97.0 %
European weighted efficiency, $\eta_{\text{EU}}$	96.5 %	96.5 %

## 13.2 Climatic Conditions

### Installation in accordance with IEC 60721-3-3, Class 4K4H

Extended temperature range	-25 °C to +60 °C
Extended humidity range	0% to 100%
Extended air pressure range	79.5 kPa to 106 kPa

### Transport in accordance with IEC 60721-3-2, Class 2K3

Temperature range	-25 °C to +70 °C
-------------------	------------------

## 13.3 Protective Devices

DC reverse polarity protection	Short-circuit diode
Input-side disconnection point	DC load-break switch
AC short-circuit current capability	Current control
Grid monitoring	SMA Grid Guard 6
Maximum permissible fuse protection	32 A
Ground fault monitoring	Insulation monitoring: $R_{\text{iso}} > 200 \text{ k}\Omega$
All-pole sensitive residual-current monitoring unit	Available

## 13.4 Equipment

DC connection	SUNCLIX DC connector
AC connection	AC connector
WLAN	As standard
SMA Speedwire/Webconnect	As standard
RS485	As standard

## 13.5 Torques

Screws for securing the inverter to the wall mounting bracket	2.5 Nm
Additional grounding	2.5 Nm
SUNCLIX swivel nut	2.0 Nm
Screw terminals of the AC connector	1.4 Nm

## 13.6 Data Storage Capacity

Energy yields in the course of the day	63 days
Daily yields	30 years
Event messages for users	1024 events
Event messages for installers	1024 events

## 14 Contact

If you have technical problems with our products, please contact the SMA Service Line. The following data is required in order to provide you with the necessary assistance:

- Device type
- Serial number
- Firmware version
- Event message
- Mounting location and mounting height
- Type and number of PV modules
- Optional equipment, e.g. communication products
- Use the name of the system in Sunny Portal (if available)
- Access data for Sunny Portal (if available)
- Special country-specific settings (if available)

Deutschland	SMA Solar Technology AG	Belgien	SMA Benelux BVBA/SPRL
Österreich	Niestetal	Belgique	Mechelen
Schweiz	Sunny Boy, Sunny Mini Central, Sunny Tripower: +49 561 9522-1499	België	+32 15 286 730
	Monitoring Systems (Kommunikationsprodukte): +49 561 9522-2499	Luxemburg	SMA Online Service Center: www.SMA-Service.com
	Hybrid Controller (PV-Diesel-Hybridsysteme): +49 561 9522-3199	Luxembourg	
	Sunny Island, Sunny Boy Storage, Sunny Backup: +49 561 9522-399	Nederland	
	Sunny Central, Sunny Central Storage: +49 561 9522-299	Česko	SMA Service Partner TERMS a.s.
	SMA Online Service Center: www.SMA-Service.com	Magyarország	+420 387 6 85 111
		Slovensko	SMA Online Service Center: www.SMA-Service.com
		Türkiye	SMA Service Partner DEKOM Ltd. Şti. +90 24 22430605
			SMA Online Service Center: www.SMA-Service.com
France	SMA France S.A.S. Lyon +33 472 22 97 00	Ελλάδα	SMA Service Partner AKTOR FM.
	SMA Online Service Center : www.SMA-Service.com	Κύπρος	Αθήνα +30 210 8184550
			SMA Online Service Center: www.SMA-Service.com

España Portugal	SMA Ibérica Tecnología Solar, S.L.U. Barcelona +34 935 63 50 99 SMA Online Service Center: www.SMA-Service.com	United King- dom	SMA Solar UK Ltd. Milton Keynes +44 1908 304899 SMA Online Service Center: www.SMA-Service.com
Italia	SMA Italia S.r.l. Milano +39 02 8934-7299 SMA Online Service Center: www.SMA-Service.com	Australia	SMA Australia Pty Ltd. Sydney Toll free for Australia: 1800 SMA AUS (1800 762 287) International: +61 2 9491 4200
United Arab Emirates	SMA Middle East LLC Abu Dhabi +971 2234 6177 SMA Online Service Center: www.SMA-Service.com	India	SMA Solar India Pvt. Ltd. Mumbai +91 22 61713888
ไทย	SMA Solar (Thailand) Co., Ltd. กรุงเทพฯ +66 2 670 6999	대한민국	SMA Technology Korea Co., Ltd. 서울 +82-2-520-2666
South Africa	SMA Solar Technology South Africa Pty Ltd. Cape Town 08600SUNNY (08600 78669) International: +27 (0)21 826 0699 SMA Online Service Center: www.SMA-Service.com	Argentina Brasil Chile Perú	SMA South America SPA Santiago de Chile +562 2820 2101
Other coun- tries	International SMA Service Line Niestetal 00800 SMA SERVICE (+800 762 7378423) SMA Online Service Center: www.SMA-Service.com		

## 15 EU Declaration of Conformity

within the scope of the EU directives

- Electromagnetic compatibility 2014/30/EU (29.3.2014 L 96/79-106) (EMC)
- Low Voltage Directive 2014/35/EU (29.3.2014 L 96/357-374) (LVD)
- Radio Equipment Directive 2014/53/EU (22.5.2014 L 153/62) (RED)



SMA Solar Technology AG confirms herewith that the products described in this document are in compliance with the fundamental requirements and other relevant provisions of the above-mentioned directives. The entire EU Declaration of Conformity can be found at [www.SMA-Solar.com](http://www.SMA-Solar.com).





