

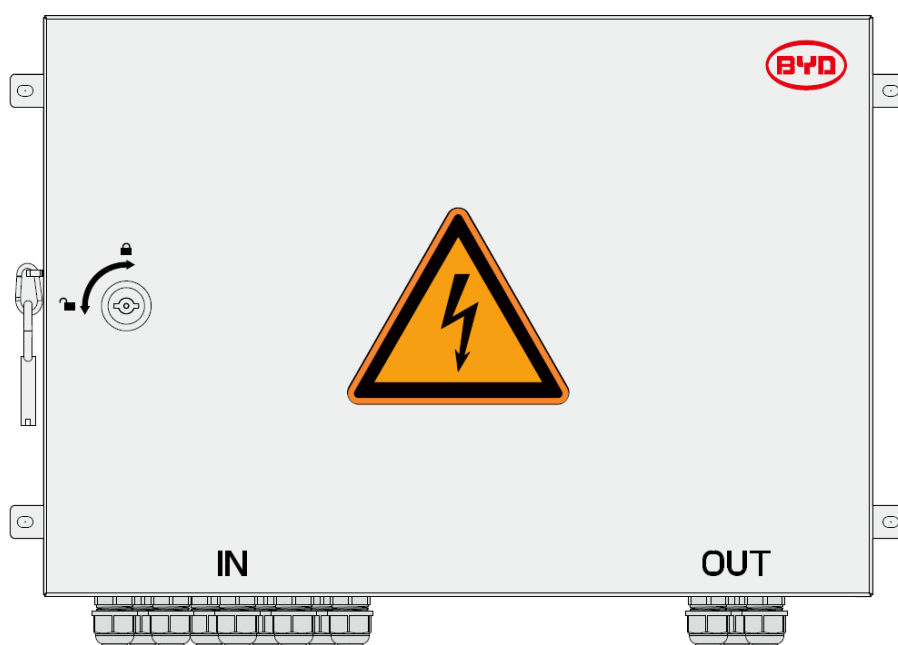

Battery-Box Premium HVS/HVM Combiner Box Installation Manual

Model: CBH-40A

V1.2



BYD Smart Device Hungary Kft.

Legal Provisions

All the information in this document is the property of BYD Smart Device Hungary Kft. No part of this document could be reproduced in any way for business use. Internal use is allowed.

BYD Smart Device Hungary Kft. makes no representations or warranties express or implied, with respect to this document, including (with no limitation) any implied warranties of utility, merchantability, or fitness for any particular purpose. All such representations or warranties are expressly disclaimed. Neither BYD Smart Device Hungary Kft. nor its distributors or dealers shall be liable for any indirect, incidental, or consequential damages under any circumstances.

The exclusion of implied warranties may not apply in all cases under some statutes, and thus the above exclusion may not apply.

This document does not replace and is not intended to replace any local, state, provincial, federal, or national laws, regulations, or codes applicable to the installation, electrical safety, and use of the battery system. BYD Smart Device Hungary Kft. assumes no responsibility for the compliance or noncompliance with such laws or codes in connection with the installation of the battery system.

Specifications are subject to change without notice. Every effort has been made to make this document complete, accurate, and up-to-date. However, BYD Smart Device Hungary Kft. may need to make some improvements under certain circumstances without advance notice. BYD Smart Device Hungary Kft. shall not be responsible for any loss caused by this document, including, but not limited to, omissions errors, typographical errors, arithmetical errors, or listing errors in this document.

All trademarks are recognized.

BYD Smart Device Hungary Kft.

H-2071 Páty, Szent József út 4.

Content

Legal Provisions.....	2
1. Information on this Document	5
1.1. Validity	5
1.2. Target Group.....	5
1.3. Symbols	5
2. Safety	6
2.1. Intended Use.....	6
2.2. Instructions and Warnings.....	6
2.3. Position and securing	6
2.4. Safety Precautions	6
3. Scope of delivery	8
4. Product Description	9
4.1. Circuit Diagram.....	9
4.2. Type Label.....	9
4.3. Symbols on the Type Label.....	10
5. Assembly.....	11
5.1. Wall Mounting.....	11
5.1.1. Selecting the Mounting Location.....	11
5.1.2. Mounting the Combiner Box	11
6. Electrical Connection	13
6.1. Connection Instructions	13
6.1.1. Preliminary Checks.....	13
6.1.2. Safety during Electrical Connection	14
6.2. Inserting the Cables into the Switch Cabinet	14
6.2.1. Bottom view of Combiner Box with cable glands	14
6.2.2. Overview of the Connection Area	15
6.3. Leading the Cables through the Cable Glands with sealing Gasket.....	15
6.4. Connecting the DC Cables	16
6.5. Connecting the Grounding Cable	17
7. Maintenance	18
7.1. Periodic Maintenance	18
7.2. Extraordinary Maintenance	18

8.	Decommissioning.....	19
8.1.	Disassembling the Combiner Box.....	19
8.2.	Disposing of the Combiner Box.....	19
9.	Technical Data.....	20
10.	Contact Information	22

1. Information on this Document

1.1. Validity

This document is valid for the Battery-Box Premium HVS/HVM Combiner Box CBH-40A.





1.2. Target Group

The instructions in this document may only be performed by qualified persons who must have the following skills:

- Knowledge of how batteries work and are operated
- Knowledge of how an inverter works and is operated
- Knowledge of, and adherence to the locally applicable connection requirements, standards, and directives
- Knowledge of, and adherence to this document and the associated system documentation, including all safety instructions
- Training in dealing with the hazards associated with the installation and operation of electrical equipment and batteries
- Training in the installation and commissioning of electrical equipment

Failure to do so will make any manufacturer's warranty, guarantee or liability null, and void unless you can prove that the damage was not due to non-compliance.

1.3. Symbols







Symbol	Explanation
	Indicates a hazardous situation which, if not avoided, will result in death or serious injury
	Indicates a hazardous situation which, if not avoided, can result in death or serious injury
	Indicates a hazardous situation which, if not avoided, can result in minor or moderate injury
	Indicates a situation which, if not avoided, can result in property damage
	Packaging instructions

2. Safety

2.1. Intended Use



2.2. Instructions and Warnings

Failure to follow these instructions may have serious consequences, such as the destruction of the device, personal injury or death due to electric shock. Therefore, the following safety instructions must be read and understood prior to installation and use of the Combiner Box. For any clarifications or additional information, contact the BYD local service.

Symbol	Explanation
	Once the product has been removed from its original packaging, visually inspect for damage that may have occurred during shipment. If damage is found, contact the distributor or manufacturer.
	This product must only be used for the purpose for which it has been designed. Any other use is considered improper and therefore dangerous. The manufacturer is not liable for possible damage caused by improper, incorrect or unreasonable use
	BYD holds itself responsible only for the product in its original configuration. BYD declines all responsibility for consequences deriving from non-original spare parts.
	Any intervention that alters the structure or the operating cycle of the product must be carried out or authorized by BYD Smart Device Hungary Kft.
	This manual is an integral and essential part of the product. Carefully read the recommendations contained in it since they provide important information on safe use and maintenance.
	BYD may make technical changes in this manual and to the product at any time without notice. In case of typing errors or other types of errors, the corrections will be included in the new versions of the manual.

2.3. Position and securing

Failure to follow these instructions may have serious consequences, such as the destruction of the device, personal injury or death due to electric shock. Therefore, the following safety instructions must be read and understood prior to installation and use of the Combiner Box. For any clarifications or additional information, contact BYD local service.

Symbol	Explanation
	If positioning in a closed environment, make sure the area is ventilated and allows regular recirculation of air. If installing in an open environment, position the enclosure in an area that is constantly shaded and protected from exposure to direct sunlight. These measures are important for preventing unnecessary and excessive overheating, which prolonged in time impairs the duration and operation of parts inserted inside.
	Make sure the wall where the enclosure is to be mounted is suitable to support the weight. The weight is around 10 kg.

2.4. Safety Precautions

This section contains safety precautions that must be observed at all times when working on or with the product. To prevent personal injury and property damage and to ensure long-term operation of the product, read this section carefully and follow all safety precautions at all times.

⚠ DANGER**Danger to life from electric shock due to live voltage**

High voltages are present in the live components of the Combiner Box. Touching live components results in death or serious injury due to electric shock.

- Wear personal protective equipment when working on the Combiner Box.
- Do not touch live components.
- Before performing any work, always disconnect the Combiner Box from voltage sources unless supply voltage is absolutely necessary.
- Ensure that the device cannot be reconnected.
- Ensure that no voltage is present.
- Ground and short-circuit.
- Cover or isolate any adjacent live components. Protective covers must always be mounted.

Danger to life from electric shock due to live DC cables

Touching live DC cables from batteries or an inverter results in death or serious injury.

- Prior to connecting the DC cables, ensure that the DC cables are voltage-free.
- Wear suitable personal protective equipment when working on the Combiner Box.

⚠ DANGER**Danger to life from electric shock if the Combiner Box is damaged**

If the Combiner Box is damaged, dangerous situations may arise during operation that results in death or serious injury from electric shock.

- Only use the Combiner Box when it is in a technically faultless condition and safe to operate.
- Regularly check the Combiner Box for visual damage.
- Make sure that all external safety equipment is freely accessible at all times.
- Make sure that all safety equipment is in good working order.

3. Scope of delivery

Check the scope of delivery for completeness and any externally visible damage. Contact your distributor if the scope of delivery is incomplete or damaged.

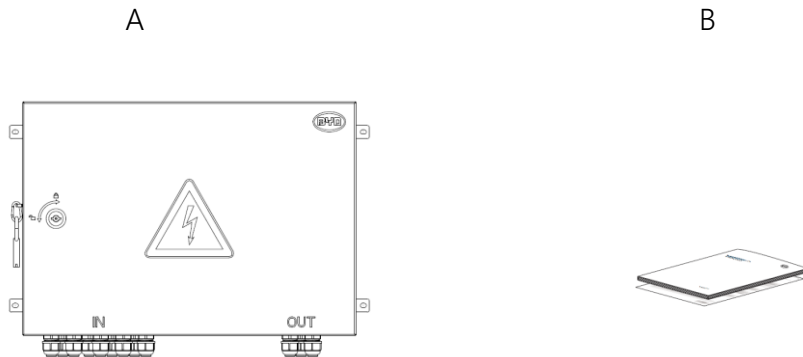

Figure 1 Component included in the scope of delivery

A	Battery-Box Premium HVS/HVM Combiner Box CBH-40A
B	Installation Manual

4. Product Description

4.1. Circuit Diagram

The CBH-40A Combiner Box is a BYD battery system junction box to an inverter. Up to three HVS/HVM battery towers could be connected in parallel with this Combiner Box.

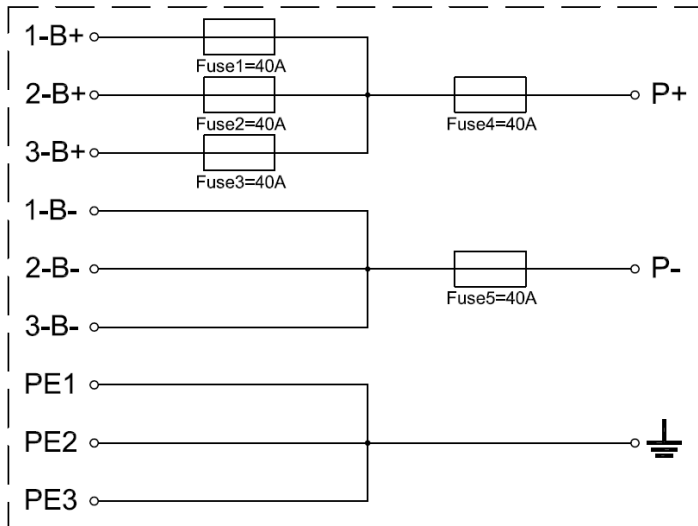

Figure 2 Block circuit diagram of the CBH-40A Combiner Box

“1-B+”, “1-B-” and “PE 1” in the diagram above mean the positive power cable, negative power cable, and grounding cable from the battery tower Number 1.

4.2. Type Label

There is one type label attached to the Combiner Box.

The type label is located on the left upside of the Combiner Box.

You will find the following information on the type label:

- Manufacturer
- Device type
- Serial number
- Device-specific characteristics
- Production date

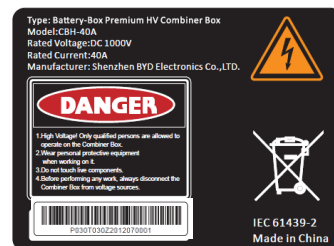



P030 T 03 0 Z 201207 0001

Production date: Year Month Day

You will require the information on the type label to use the product safely and when seeking customer support from the BYD local service. The type label must remain permanently attached to the product.

4.3. Symbols on the Type Label

Symbol	Explanation
	<p>Beware of electrical voltage.</p>
	<p>WEEE designation Do not dispose of the system together with the household waste but in accordance with the disposal regulations for electronic waste applicable at the installation site.</p>
	<p>Indicates a hazardous situation which, if not avoided, will result in death or serious injury.</p>

5. Assembly

5.1. Wall Mounting

5.1.1. Selecting the Mounting Location

WARNING

Fire hazard due to wrong choice of mounting location

Under fault conditions electric arcs may occur in the Combiner Box. Electric arcs can cause fires if the Combiner Box is mounted on flammable materials.

- Do not mount the Combiner Box on flammable construction materials.
- Do not mount the Combiner Box near highly flammable materials.
- Do not mount the Combiner Box in potentially explosive atmospheres.

Requirements for the mounting location:

- o The mounting location must not be in a living or office area.
- o The mounting location must not block any escape routes.
- o The mounting location must be freely and safely accessible at all times without the necessity for any auxiliary equipment (such as scaffolding or lifting platforms). Non-fulfillment of these criteria may restrict servicing.
- o The mounting location must be suitable for the weight and dimensions of the Combiner Box.
- o The mounting location must not be exposed to direct solar irradiation.
- o The recommended height of the location is higher than 1.6 meters from the ground.
- o Make sure that the Combiner Box enclosure is not mounted in the path of rainwater.

Requirements for mounting:

- o Mount the Combiner Box in such a way that the connection area is facing downwards.
- o The recommended height of the wall box
- o Do not mount the Combiner Box in an inclined position.

5.1.2. Mounting the Combiner Box

CAUTION

Danger of crushing if the Combiner Box is dropped

- When mounting the Combiner Box, take the weight of up to 9.7 kg into account.
- Installer should use personal protective equipment.

NOTICE

Damage to cable glands and plug connections due to improper transport and installation

The cable glands and plug connections protrude from the enclosure.

Additionally required mounting material (not included in the scope of delivery):

- Four M5 screws. Take wall properties into account when choosing the screw type.
- Four washers.
- If necessary, four screw anchors. Take wall properties into account when choosing the screw anchor type.

6.5 X 9.5mm
OBROUND X 4

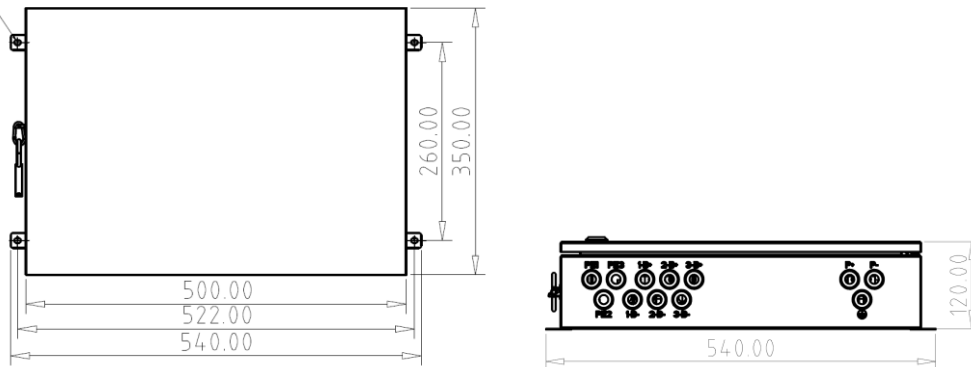

Figure 3 Dimensions of the Combiner Box

Procedure:

1. Mark the position of the drill holes on the wall or stand.
2. Drill holes at the marked positions.
3. If necessary, insert the screw anchors.
4. Fasten the Combiner Box to the wall or stand using suitable screws and washers.
5. Ensure that the Combiner Box is securely fixed.

6. Electrical Connection

6.1. Connection Instructions

6.1.1. Preliminary Checks

DANGER

Before connecting the Combiner Box to the battery and inverter, make sure that:

- The Combiner Box is in good condition and there was no damage during transport.
- The Combiner Box is firmly anchored to walls and stable supports.
- There are no remaining metallic parts, chips and derivatives from the installation activities.

DANGER

After performing the checks listed in the points above, proceed to wire the cables according to what is shown in the wiring diagram, making sure to use suitable sizes and colors.

CAUTION

Make sure that the DC connections are properly secured inside the terminals in order to prevent possible overheating that may lead to dangerous situations.

6.1.2. Safety during Electrical Connection



Danger to life due to electric shock

High voltages are present in the live components of the Combiner Box. Therefore, work on the Combiner Box is only allowed if the power is disconnected and the guidelines that apply at the installation location are strictly followed.

- Disconnect from voltage sources:
- Ensure that the device cannot be reconnected.
- Ensure that no voltage is present.
- Ground and short-circuit.
- Cover or isolate any adjacent live components. Protective covers must always be mounted.

6.2. Inserting the Cables into the Switch Cabinet

6.2.1. Bottom view of Combiner Box with cable glands

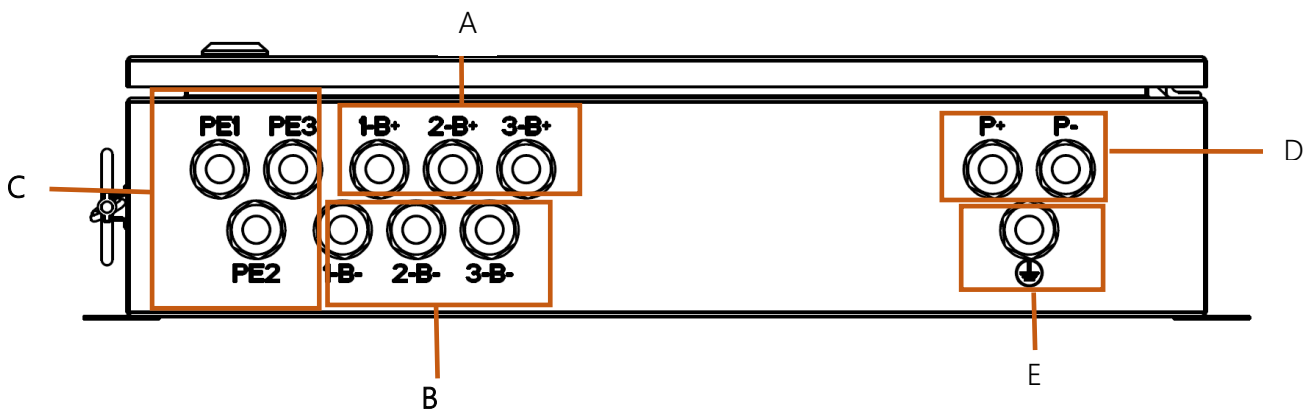

Figure 4 Bottom view of Combiner Box with cable glands

Position	Description
A	Cable entry for connecting positive power cables from battery towers
B	Cable entry for connecting negative power cables from battery towers
C	Grounding cables input from battery towers
D	Output DC cable glands to an inverter
E	Grounding cable output gland to a common ground point

6.2.2. Overview of the Connection Area

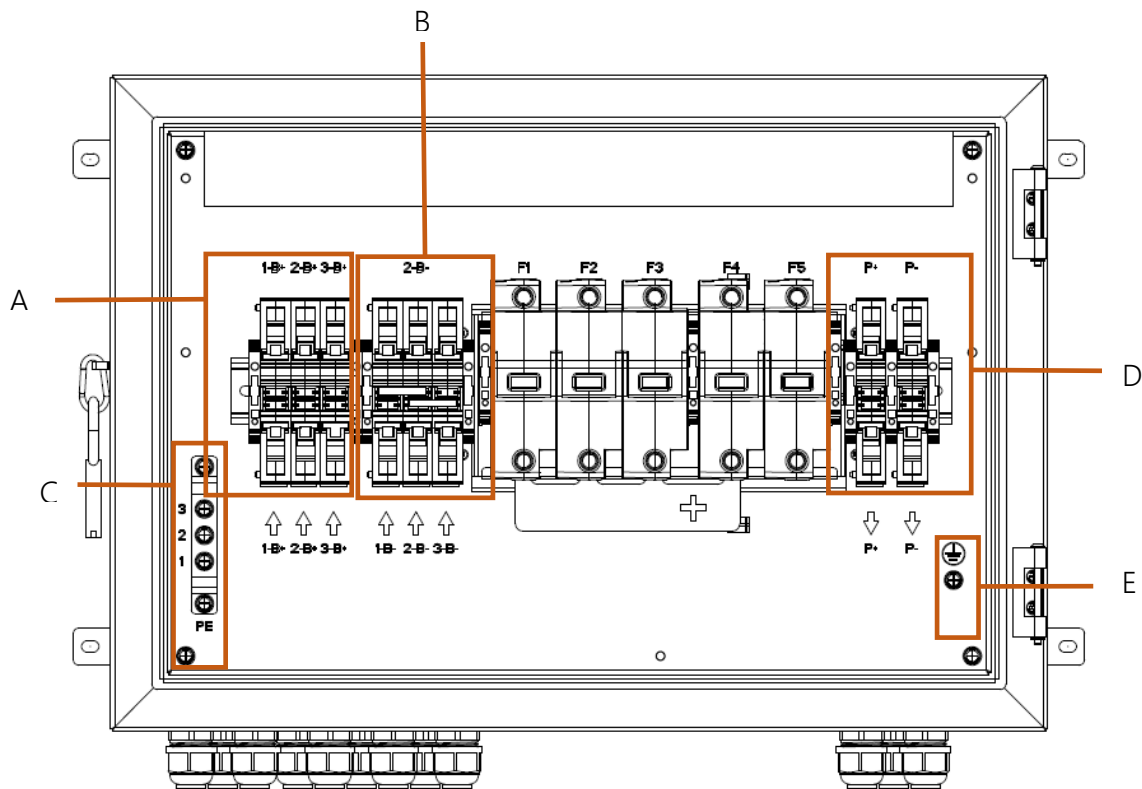

Figure 5 Overview of the connection area

Position	Description
A	Positive input cable blocks
B	Negative input cable blocks
C	Grounding posts for input grounding cables
D	Output DC cable blocks
E	Grounding post for output grounding cable

6.3. Leading the Cables through the Cable Glands with sealing Gasket

Procedure:

1. Release the cable gland.
2. Lead the cable through the swivel nut of the cable gland. Ensure that the thread of the swivel nut is facing upwards.
3. Lead the cable through the seal insert.
4. Insert the seal insert into the cable gland together with the cable.

5. Cut the cable to length.

6.4. Connecting the DC Cables

BYD recommends using bootlace ferrules for connecting the DC cables to the blocks.

NOTICE

Damage to the Combiner Box due to moisture penetration

- Moisture can penetrate the Combiner Box through unsealed cable glands.

Cable requirements:

The diameter of the DC cables: 5 mm to 12.5 mm.

Cross section: 6 mm² to 16 mm²

Procedure:

1. Attach the cables to an external cable support rail.
2. Cut the cables to length and strip 25 mm off the insulation.
3. If you are using bootlace ferrules, mount the bootlace ferrules and crimp gas-tight.
4. Lead the cables to the blocks.
5. Insert a flat-head screwdriver into the switch of the connector.(recommended screwdriver type, S3.5×100)

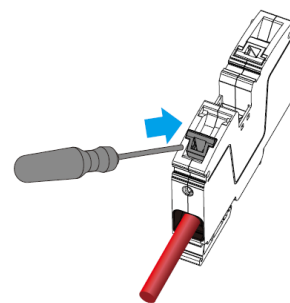
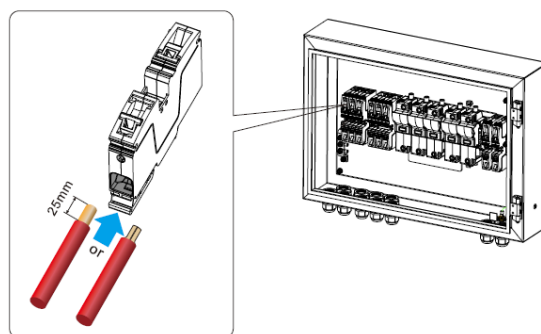

6. Hold the cables, and push up the screwdriver to make the switch go to the end.

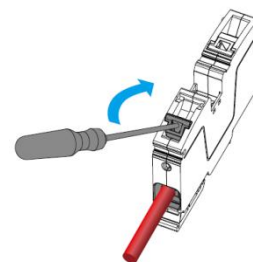

7. Make sure the switch is well fixed at the end of the sink.
8. Remove the screwdriver from the connector.

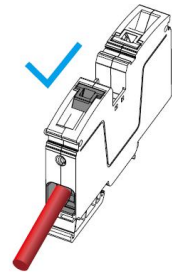

6.5. Connecting the Grounding Cable

Cable requirement

- Conductor cross-section: 10 -16 mm²
- Outer diameter: 5 mm to 12.5 mm
- With a ring terminal

Procedure:

1. Loose the original nut and washer on the ground post.
2. Put the grounding cable in the ground post.
3. Tighten the nut and washer. (torque: 5.5 Nm).
4. Ensure that the grounding cable is securely fixed.

7. Maintenance

7.1. Periodic Maintenance

It is recommended to periodically inspect the panel and check the following points:

- There are no evident signs of rust or corrosion which may impair functioning and safety.

(Yearly - Visual inspection)

- There are no water infiltrations and excessive dust infiltration.

(Yearly - Visual inspection)

- The mass grounding and drains are efficient.

(Yearly - Visual inspection)

- There is insulation between the electrical circuits and masses.

(5 Year - Insulation test)

- All the DC connections are correctly tightened.

(Yearly - Dynamometric torque tool)

- There are no burn marks on the terminals.

(Yearly - Visual inspection)

- The door panel of the enclosure is firmly closed at the end of all the checks and after any maintenance.

(Yearly - Visual inspection)

7.2. Extraordinary Maintenance

If damaged components need to be replaced only use materials identical to those originally supplied.

If the electrical connections are damaged due to mechanical or electrical causes or due to rodents, immediately disconnect the system or at least the damaged part. After verifying that no failures were caused to the equipment, proceed with the replacement of the wires using similar materials.



All the maintenance operations must be performed by taking into account all safety instructions, checking beforehand that the components are not powered.

8. Decommissioning

8.1. Disassembling the Combiner Box

DANGER

Danger to life due to electric shock when touching live components of the Combiner Box

- Observe the following safety rules when disconnecting:
 - Disconnect from voltage sources.
 - Ensure that the device cannot be reconnected.
 - Check that no voltage or current is present.
 - Ground and short-circuit.
 - Cover or isolate any adjacent live components.

CAUTION

Risk of burns from touching hot components

Requirement:

The Combiner Box must be disconnected from voltage sources.

Procedure:

1. Open the doors of the Combiner Box.
2. Disconnect the input cables from the blocks.
3. Disconnect the output cables.
4. Disconnect the grounding cables.
5. Release the cable glands.
6. Pull all cables out of cable glands and isolate them.
7. Disassemble the Combiner Box.

8.2. Disposing of the Combiner Box

Dispose of the Combiner Box in accordance with the applicable disposal regulations for electronic waste.

9. Technical Data

General Data	
Maximum Operating Voltage (Un)	1000V DC
Rated Insulation Voltage (Ui)	1000V DC
Rated Impulse Voltage (Uimp)	6kV
Maximum input current per battery tower	35 A
Maximum output current	40A
Rated Current of the ASSEMBLY (InA):	40A
Rated short-time withstand current (Icw)	< 10kA
Pollution degree	3
Fuse holder	Rail Mounting -1,500 VDC
Fuse type	40A 22x58 - 1,500 VDC - gPV
MECHANICAL DATA	
Enclosure	SGCC (Galvanized Cold Rolled Steel)
Length/ Width/ Height	540×350×120mm
Weight	9.7kg
Degree of Protection	IP55
Type of electrical connection	FFF – fixed connection
Form of separation	Form1 (no internal separation)

ENVIRONMENT DATA

Ambient temperature during normal operation	-10~+50°C (Note 1)
Ambient temperature during storage	-10~+50°C
Humidity	0 % to 95 % non-condensing
Altitude	up to 4,000 m (Note 2)

DC INPUT DATA

Maximum number of battery towers	3
Input cable glands entry	9 M20×1.5 with 1 input each
Input connection	Directly on terminal blocks
DC conductor cross-section	6 mm ² to 16 mm ²
Ground cable cross-section	10 mm ² to 16 mm ²

DC OUTPUT DATA

Output cable glands entry	3 M20×1.5 with 1 input each
Input connection	Directly on terminal blocks
DC conductor cross-section	6 mm ² to 16 mm ²
Ground cable cross-section	10 mm ² to 16 mm ²

(Note 1): Derating of 0.5%/K of max. current from 40°C to 50°C.

(Note 2): Derating of maximum voltage versus altitude. 1.5 % per 100 m from 2,001 m to 3,000 m.

1.0% per 100 m from 3,001 m to 4,000m.

10. Contact Information

BYD Global Service

bboxservice@byd.com

Telephone: +86 755 89888888-47175

Address: No.3009, BYD Road,
Pingshan, Shenzhen, 518118, P.R.China

www.bydbatterybox.com

Social media link

<https://www.facebook.com/BatteryBoxBYD/>

https://twitter.com/BYD_BatteryBox

<https://www.linkedin.com/company/byd-battery-box>

Australia Alps Power Pty Ltd
service @alpspower.com.au
Telephone: +61 2 8005 6688 Address:
14/47-51 Lorraine St Peakhurst NSW
221
www.alpspower.com.au

Europe EFT-Systems GmbH
service@eft-systems.de
Telephone +49 9352 8523999
+44 (0) 2037695998(UK)
+34 91 060 22 67(ES)
+39 02 873683(IT)
Address: Bruchtannenstraße 28, 63801
Kleinostheim, Germany
www.eft-systems.de

South Africa AFRIPLUS ENERGY GROUP (PTY) LTD
Support@afriplusenergy.co.za
Telephone: +27 21 140 3594
Address: The Pavilion, Corner of Dock
& Portswood Road, V&A
WATERFRONT, 8001, CAPE TOWN

USA BYD US service
bboxuservice@byd.com
Telephone: +1(833) 338-8721
